



LANDSCAPE LIGHTING KIT

Installation Instructions

Need help?

Call us

7 DAYS A WEEK
(813) 978-3700

M-F: 8 AM - 8 PM (EST)
S-S: 10 AM - 6 PM (EST)

VOLT Lighting, LLC
15486 N. Nebraska Ave.
Lutz, FL 33549
www.voltlighting.com



Transformer



Area Light



Spotlight



Wire Cutter/Stripper



Hub



Transformer Wire

1 ASSEMBLE PARTS

Assemble the transformer

by attaching the pedestal (1) with the screws provided (2). Also attach the large black stakes to the bottom of the pedestal (3).

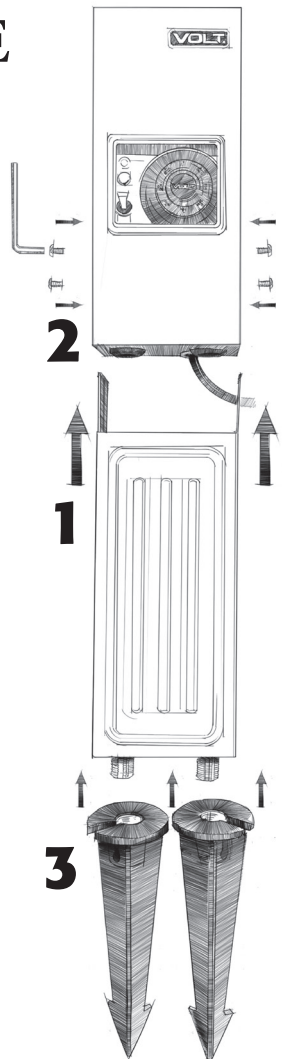

Assemble the hub by attaching the smaller black ground stakes with the screws provided.

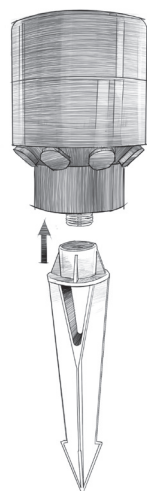

Assemble the area light stems by attaching the brown ground stakes to the path light stems with the screws provided.

Remove the top portion of the fixture, insert the bulb and replace top.

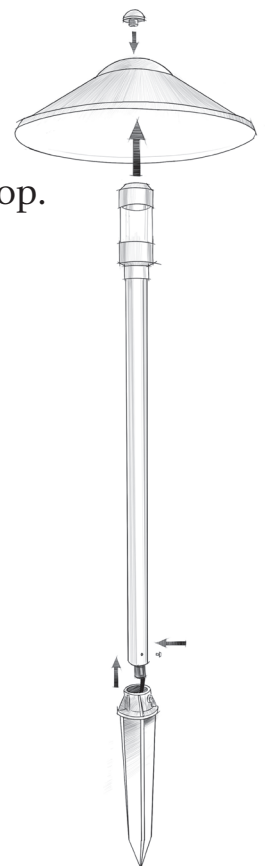
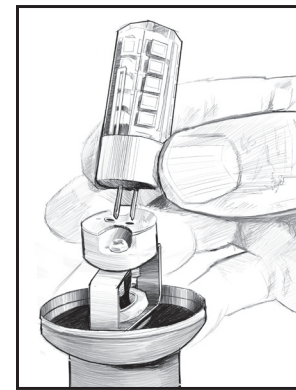

2 DEVELOP A PLAN

Develop a plan for the placement of the transformer, hubs and light fixtures in and around your landscaping.

- Position the transformer near an electrical outlet, preferably near the center of the installation.
- Fixtures have a 25 foot lead wire and should be located within 25 feet of the hubs.
- The kit has 100 feet of transformer wire. Hubs should be located within 50 feet of the transformer.

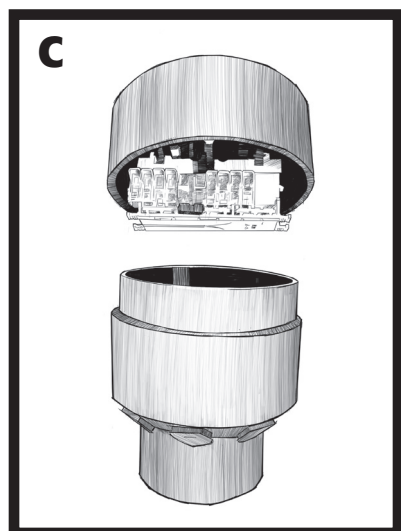
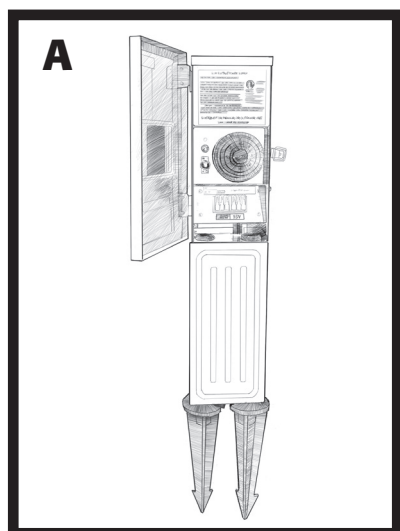
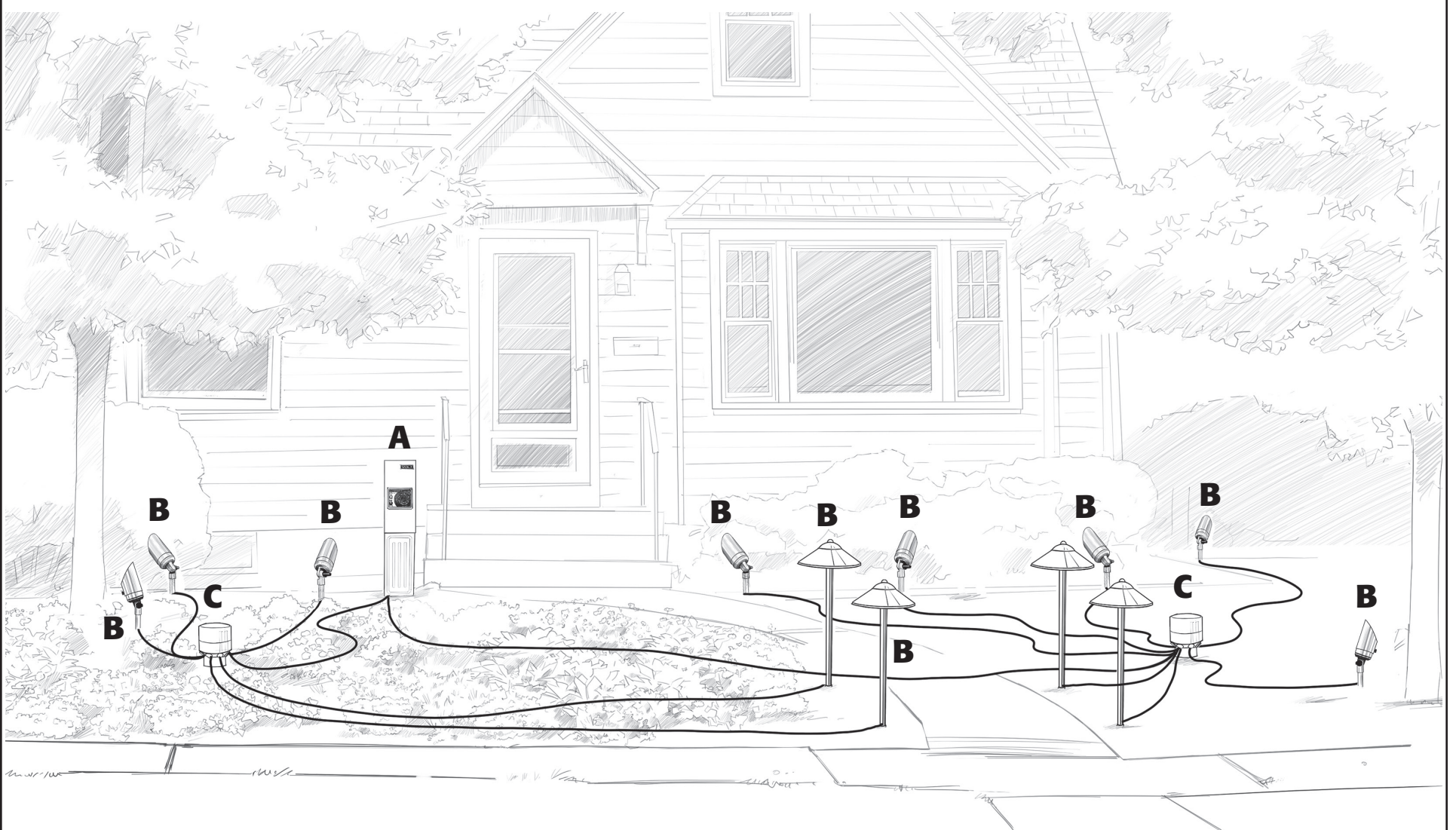

- A** Place the transformer in the ground near an electrical outlet that meets electrical codes. *Do not plug in the transformer at this point.* If necessary loosen the dirt with a shovel to allow easy installation of the transformer. Make sure the transformer is not obstructed by plant materials, allowing the photocell, which is located on the timer, to sense light levels.
- B** Position the light fixtures as desired near plants, trees, walkways or structures.
- C** Position each of the two hubs so that they're centrally located among the fixtures per the plan developed.

3 SET UP WIRING

(Where does this text go?)

The kit includes 100 feet of supply wire, this can be cut at any point to provide two lengths of cable to connect the transformers with the hubs.

- A** Run the wires from the fixtures to the hubs closest to them. Adjust the position of the hubs to allow connection with all fixtures as needed. Leave the wires at full length to allow adjustment of fixture location later.
- B** Run supply wires from the transformer to the hubs and insert wires into the hubs.
- C** Insert wires into the hubs. Strip the ends of the wires with the wire strippers provided. Twist the wires for easy insertion into orange terminal blocks.
- D** Temporarily connect the wires from the fixtures and the transformers to the hub terminal blocks. Affix one wire from each pair onto either side of the terminal block and flip orange terminal block lever up.
- E** Feed supply wire through bottom/back of transformer. Connect the supply wire to the terminal blocks in the transformer.

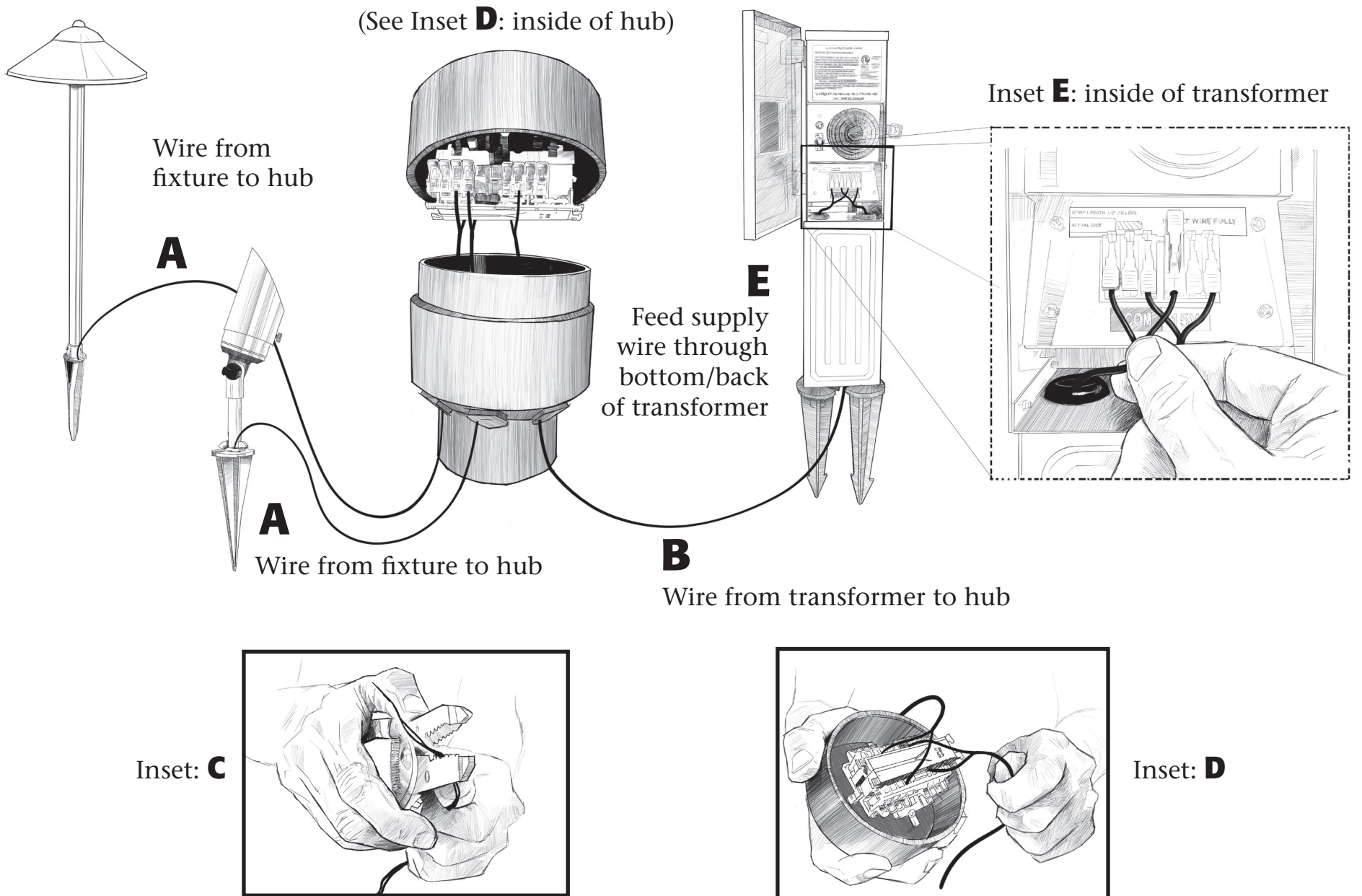

4 TURN ON, TEST LIGHTS, AND ADJUST LOCATIONS

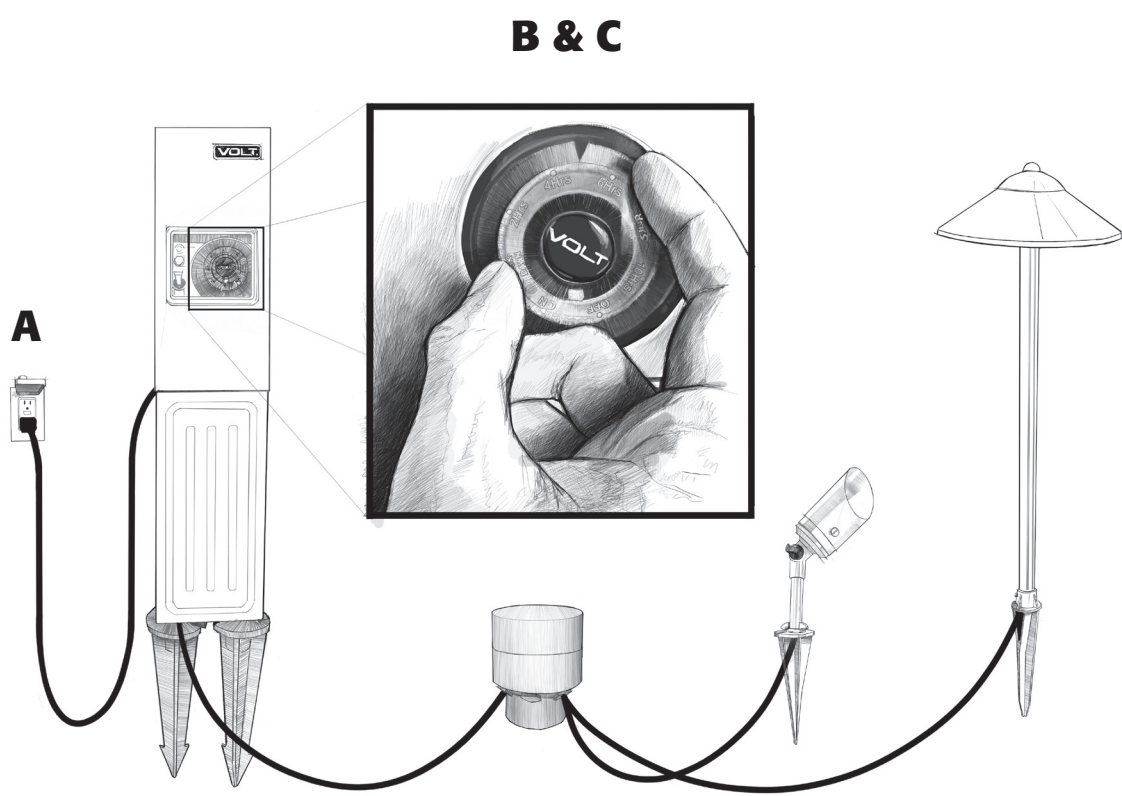

- A** Plug the transformer in to the electrical outlet. The green light indicates that power is on. The blue light indicates that the timer is working.
- B** Turn the timer to the "On" position. Revisit the installation after dark to adjust the position of the fixtures. Make the appropriate adjustments to the fixture to focus the fixture and get the right level of illumination.
- C** Turn the dial on the timer to select the desired setting.
- D** When satisfied with the location of the hubs and the fixtures, the wires can be shortened at the hubs. Twirl wires together to enable hub lid to close. If so desired, the wire can be buried or covered with mulch.



Need help? Call me!

7 DAYS A WEEK

(866) 865-8872

M-F: 8 AM - 8 PM (EST)

S-S: 10 AM - 6 PM (EST)



VOLT Lighting, LLC

15486 N. Nebraska Ave., Lutz, FL 33549

www.voltlighting.com