



Production Fastening Assembly Tools



REAL TOOLS FOR REAL WORK.™

Contents

Electric Fastening Tools



12
Electric Screwdrivers



Other Air Tools



73
Air Riveters



74
Calibration Equipment



Air Fastening Tools



23
Pistol Grip Air Screwdrivers



38
Inline Air Screwdrivers



47
Angle Air Nutrunners



62
Inline Air Nutrunners



70
Pulse Tools



Accessories



76
Spring Balancers



78
Torque Reaction Arms & Holders



80
Workstations



81
Spindle Accessories



83
Other Accessories



Reference Guides

84

Clutch Selection

85

Torque Table Guide

Model Identification Guide

5 & 7 Series Air Screwdrivers

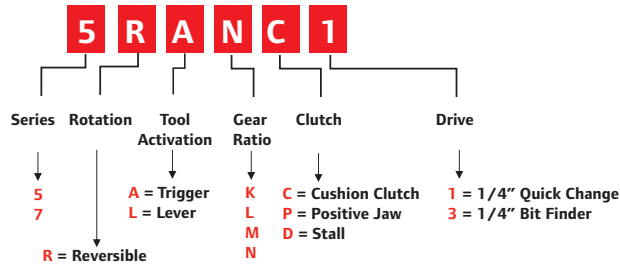

5 & 7 Series Air Nutrunners

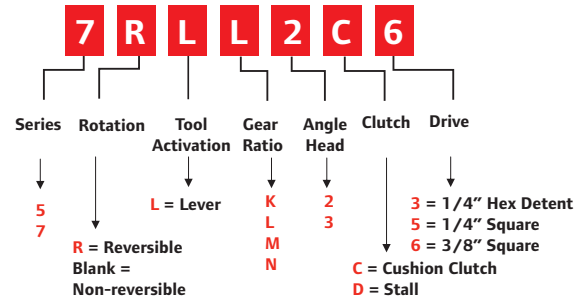

Versatec Electric Screwdrivers

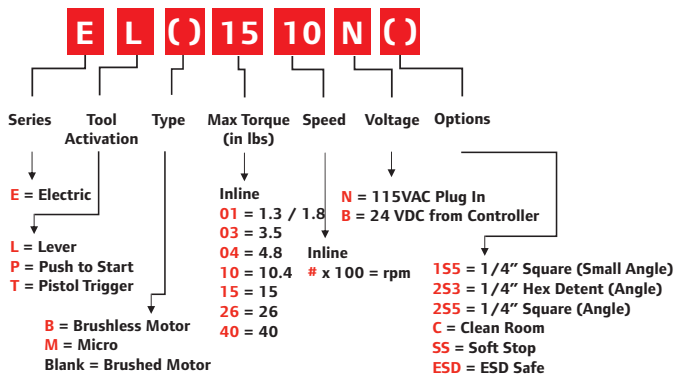

41 Series Air Screwdrivers / Nutrunners

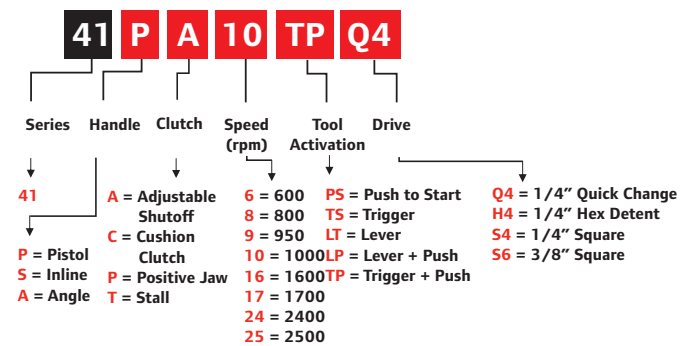

QA Series Air Nutrunners

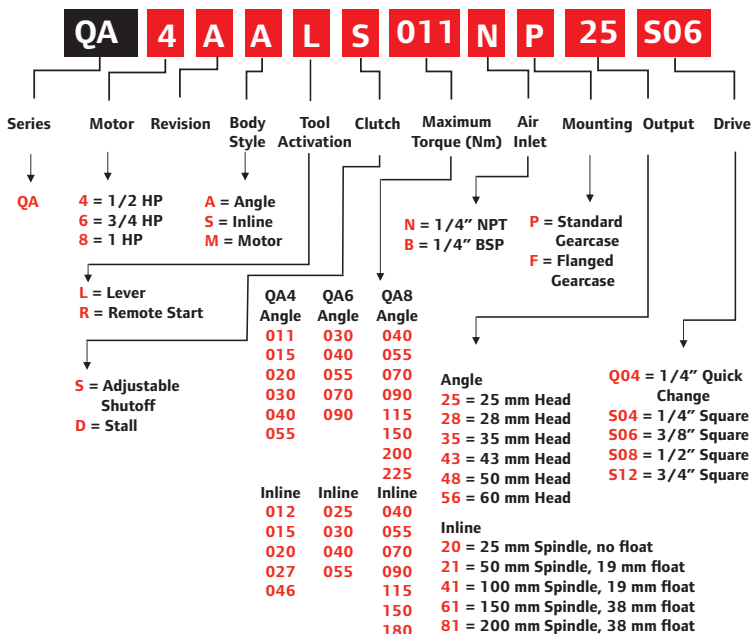



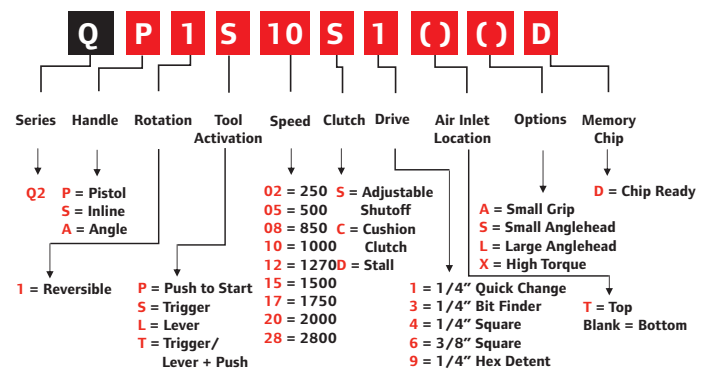







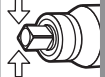























Q2 Series Air Screwdrivers / Nutrunners



































Technical Symbols

For ease of use, specification tables frequently use symbols in column headings. Please reference the chart below for exact descriptions.

 Voltage	 Reversible models	 Stall torque	 Square drive or bit holder
 Spindle accessories	 Non-reversible models	 Blows per minute	 Floating spindle stroke
 Riveting	 Torque range	 Tool weight	 Rivet set shank diameter
 Spring balancers	 Torque range with light clutch spring	 Max. air consumption	 Tool length
 Pistol grip fastening tools	 Torque range with medium clutch spring	 Piston stroke	 Tool length
 Straight fastening tools	 Torque range with heavy clutch spring	 Bit holder or Square drive	 Tool length
 Angle fastening tools	 Max. free speed	 Square drive or bit holder	 Tool length
 Torque control system	 Bolt capacity	 Spindle thread	 Tool length
 Tool length	 Angle head height	 Sound level	 ICS software

Technical Symbols (Cont.)

	Tool length		Angle head height		Tool air inlet connection		Calibration equipment
	Tool length		Nominal load capacity		Hose min. internal diameter		Electrode dressers
	Side-to-center distance		Standard height of lift		Rated power		Working stations
	Side-to-center distance		1/4" hex quick change		Spindle length		Other accessories
	Side-to-center distance		1/4" hex bit holder		Spindle length		Torque reaction arms & holders
	Side-to-center distance		1/4" hex insert bit holder		Size		Parts manual
	Side-to-center distance		1/4" hex bit holder (requires bit guide or finder)		Number of tools controlled		Product information manual
	Side-to-center distance		Square drive		Bore		Maintenance information manual
							Operation and maintenance manual

Electric Screwdriver

Torque Selection Guide

DC Screwdrivers	Model	0	0.25 Nm	0.5 Nm	0.75 Nm	1.0 Nm	1.25 Nm	1.5 Nm	Referral Page
		▼	▼	▼	▼	▼	▼	▼	
	EL0109B		█						14
	ELM0107N		█						12
	ELM0110N		█						12
	ELM0306N			█					12
	EL0410BC-SS-ESD			█					13
	EL0510BC-SS-ESD			█					13
	EL0410B		█	█					14
	ES45T		█	█	█				15
	EL0807BC-SS-ESD			█	█	█			13
	ES50T		█	█	█	█			15
	EL1007BC-ESD			█	█	█	█		13
	EL1007B		█	█	█	█	█		14

AC Screwdrivers	Model	0	0.5 Nm	1.0 Nm	1.5 Nm	2.0 Nm	2.5 Nm	3.0 Nm	3.5 Nm	4.0 Nm	4.5 Nm	Referral Page
		▼	▼	▼	▼	▼	▼	▼	▼	▼	▼	
	EP1520N			█	█	█						17
	EP1510N			█	█	█						17
	ES90P		█	█	█	█						18
	ES60P		█	█	█	█						18
	ES80P			█	█	█	█					18
	EP2612N				█	█	█	█				17
	EP2607N				█	█	█	█				17
	EP2603N				█	█	█	█				17
	ES70P			█	█	█	█	█				18
	EPB2612N		█	█	█	█	█	█				16
	EPB2620N		█	█	█	█	█	█				16
	ET4007N					█	█	█	█	█	█	17
	ES100T					█	█	█	█	█	█	18

Angle Head Screwdrivers	Model	0	1.0 Nm	2.0 Nm	3.0 Nm	4.0 Nm	5.0 Nm	6.0 Nm	7.0 Nm	Referral Page
		▼	▼	▼	▼	▼	▼	▼	▼	
	ES90T1S5		█	█	█					20
	EL1510N1S5		█	█	█					19
	ES90T2S3		█	█	█					20
	EL1510N2S3		█	█	█					19
	ES60T2S3		█	█	█					20
	EL2612N1S5			█	█	█				19
	ES70T1S5		█	█	█	█				20
	ES70T2S3		█	█	█	█				20
	EL2612N2S3			█	█	█	█			19
	ES100T2S3			█	█	█	█	█		20
	ET4007N2S3				█	█	█	█	█	19



Pistol Grip Air Screwdrivers

Torque Selection Guide

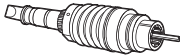
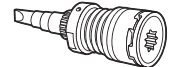
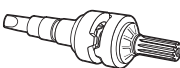
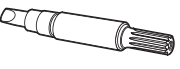
Adjustable Shut-Off Clutch	Model	0	2 Nm	4 Nm	6 Nm	8 Nm	10 Nm	12 Nm	Referral Page				
		▼	▼	▼	▼	▼	▼	▼					
	QP1T20S1D		█						23				
	QP1T10S1D		█	█					23				
	41PA24TSQ4		█	█	█				26				
	QP1T02S1D		█	█	█	█			24				
	41PA10TSQ4		█	█	█	█	█		26				
	41PA8TSQ4		█	█	█	█	█	█	26				
Adjustable Cushion Clutch	Model	0	2 Nm	4 Nm	6 Nm	8 Nm	10 Nm	12 Nm	14 Nm	Referral Page			
		▼	▼	▼	▼	▼	▼	▼	▼				
	QP1P20C1D		█							27			
	41PC25TSQ4		█	█						28			
	QP1S05C1D		█	█	█					27			
	5RANC1		█	█	█	█				29			
	41PC10TSQ4		█	█	█	█	█			28			
	41PC8TSQ4		█	█	█	█	█	█		28			
	7RALC1		█	█	█	█	█	█		29			
	7RAMC1		█	█	█	█	█	█	█	29			
Positive Jaw	Model	0	2 Nm	4 Nm	6 Nm	8 Nm	10 Nm	12 Nm	14 Nm	16 Nm	18 Nm	20 Nm	Referral Page
		▼	▼	▼	▼	▼	▼	▼	▼	▼	▼	▼	
	5RALP1		█										33
	41PP25TSQ4		█	█									32
	5RANP1		█	█	█								33
	41PP10TSQ4		█	█	█	█							32
	7RAMP1		█	█	█	█	█						33
	41PP8TSQ4		█	█	█	█	█	█					32
	7RANP1		█	█	█	█	█	█	█	█			33
Stall	Model	0	2 Nm	4 Nm	6 Nm	8 Nm	10 Nm	12 Nm	14 Nm	Referral Page			
		▼	▼	▼	▼	▼	▼	▼	▼				
	QP1S20D1D		█										34
	5RALD1		█	█									35
	QP1S10D1D		█	█	█								34
	41PD25TSQ4		█	█	█								36
	7RALD1		█	█	█	█							35
	QP1S05D1D		█	█	█	█	█						34
	41PD10TSQ4		█	█	█	█	█	█					36
	41PD8TSQ4		█	█	█	█	█	█	█				36



Inline Air Screwdrivers

Torque Selection Guide

Adjustable
Shut-Off Clutch

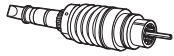

Model	0	2 Nm	4 Nm	6 Nm	8 Nm	10 Nm	12 Nm	14 Nm	Referral Page
QS1T20S1D	█	█							39
QS1T15S1D	█	█	█						39
QS1T10S1D	█	█	█	█					39
QS1T05S1D	█	█	█	█	█				39
QS1T02S1D	█	█	█	█	█	█			39
41SA10LPQ4		█	█	█	█	█	█		40
41SA8LPQ4		█	█	█	█	█	█	█	40

Adjustable
Cushion Clutch

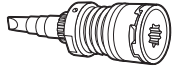

Model	0	2 Nm	4 Nm	6 Nm	8 Nm	10 Nm	12 Nm	14 Nm	Referral Page
QS1L28C1D	█								41
QS1L20C1D	█	█							41
QS1L15C1D	█	█	█						41
QS1L10C1D	█	█	█	█					41
41SC25LTQ4		█	█	█					42
5RLLC1		█	█	█	█				43
QS1L05C1D	█	█	█	█	█				41
41SC17LTQ4		█	█	█	█	█			42
5RLNC1		█	█	█	█	█			43
7RLLC1		█	█	█	█	█	█		43
41SC10LTQ4		█	█	█	█	█	█		42
41SC8LTQ4		█	█	█	█	█	█	█	42
7RLMC1		█	█	█	█	█	█	█	43

Positive Jaw



Model	0	2 Nm	4 Nm	6 Nm	8 Nm	10 Nm	12 Nm	14 Nm	Referral Page
41SP25LTQ4		█	█	█					44
41SP17LTQ4		█	█	█	█				44
41SP10LTQ4		█	█	█	█	█			44
41SP8LTQ4		█	█	█	█	█	█		44

Stall

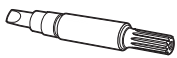

Model	0	2 Nm	4 Nm	6 Nm	8 Nm	10 Nm	12 Nm	14 Nm	Referral Page
QS1L28D1D		█	█						45
QS1L20D1D		█	█	█					45
41SD25LTQ4		█	█	█	█				46
QS1L10D1D		█	█	█	█				45
41SD17LTQ4		█	█	█	█	█			46
41SD10LTQ4		█	█	█	█	█	█		46
41SD8LTQ4		█	█	█	█	█	█	█	46



Angle Air Nutrunners

Torque Selection Guide

Adjustable
Shut-Off Clutch

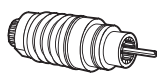

Model	0	25 Nm	50 Nm	75 Nm	100 Nm	250 Nm	Referral Page
QA1L18S4LD							47
QA1L12S4LD							47
QA1L05S4SD							48
QA1L08S4LD							47
QA1L02S4LD							48
41AA9LTS6							49
41AA6LTS6							49
QA4AALS020NP25S06							50
QA4AALS030NP28S06							50
QA6AALS040NP35S06							51
QA4AALS...							50
QA6AALS070NP35S08							51
QA8AALS070NP43S08							52
QA6AALS...							51
QA8AALS090NP43S08							52
QA8AALS...							52

Adjustable
Cushion Clutch

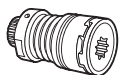

Model	0	5 Nm	10 Nm	15 Nm	20 Nm	Referral Page
QA1L18C4LD						53
QA1L12C4LD						53
5RLK2C5						55
QA1L08C4LD						53
5RLL2C5						55
QA1L05C1LD						54
5RLN2C6						55
7RLL2C6						55
7RLM3C6						55

Stall

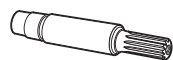

Model	0	25 Nm	50 Nm	75 Nm	100 Nm	250 Nm	Referral Page
QA1L12D4LD							56
5RLK2D6							57
5RLL2D6							57
QA1L08D4LD							56
QA1L02D6LD							56
7RLL3D6							57
QA1L05D4LD							56
5RLN2D6							57
7RLM3D6							57
7RLN3D6							57
QA4AALD...							59
9RSQ83							57
QA6AALD...							60
QA8AALD...							61



Inline Air Nutrunners

Torque Selection Guide

Adjustable Shut-Off

Model	0	40 Nm	80 Nm	120 Nm	160 Nm	200 Nm	Referral Page
QA4ASLS012NP41S06	█						62
QA4ASLS015NP41S06	█	█					62
QA4ASLS020NP41S06	█	█	█				62
QA4ASLS027NP41S06	█	█	█	█			62
QA4ASLS046NP41S06	█	█	█	█	█		62
QA6ASLS025NP41S06	█	█	█	█	█		63
QA6ASLS030NP41S06	█	█	█	█	█	█	63
QA6ASLS040NP41S06	█	█	█	█	█	█	63
QA6ASLS055NP41S08	█	█	█	█	█	█	63
QA8ASLS040NP41S08	█	█	█	█	█	█	64
QA8ASLS055NP41S08	█	█	█	█	█	█	64
QA8ASLS070NP41S08	█	█	█	█	█	█	64
QA8ASLS090NP41S08	█	█	█	█	█	█	64
QA8ASLS115NP41S08	█	█	█	█	█	█	64
QA8ASLS150NP41S08	█	█	█	█	█	█	64
QA8ASLS180NP41S08	█	█	█	█	█	█	64

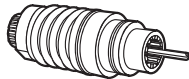

Remote Start Shut-Off

Model	0	40 Nm	80 Nm	120 Nm	160 Nm	200 Nm	Referral Page
QA4ASRS012NF41S06	█						65
QA4ASRS015NF41S06	█	█					65
QA4ASRS020NF41S06	█	█	█				65
QA4ASRS027NF41S06	█	█	█	█			65
QA4ASRS046NF41S06	█	█	█	█	█		65
QA6ASRS025NF41S06	█	█	█	█	█		65
QA6ASRS030NF41S06	█	█	█	█	█	█	65
QA6ASRS040NF41S06	█	█	█	█	█	█	65
QA6ASRS055NF41S06	█	█	█	█	█	█	65
QA8ASRS040NF41S06	█	█	█	█	█	█	66
QA8ASRS055NF41S08	█	█	█	█	█	█	66
QA8ASRS070NF41S08	█	█	█	█	█	█	66
QA8ASRS090NF41S08	█	█	█	█	█	█	66
QA8ASRS115NF41S08	█	█	█	█	█	█	66
QA8ASRS150NF41S08	█	█	█	█	█	█	66
QA8ASRS180NF41S08	█	█	█	█	█	█	66

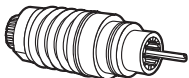

Remote Start Stall

Model	0	40 Nm	80 Nm	120 Nm	160 Nm	200 Nm	Referral Page
QA4ASRD012NF41S06	█						67
QA4ASRD015NF41S06	█	█					67
QA4ASRD020NF41S06	█	█	█				67
QA4ASRD027NF41S06	█	█	█	█			67
QA4ASRD046NF41S06	█	█	█	█	█		67
QA6ASRD025NF41S06	█	█	█	█	█		68
QA6ASRD030NF41S06	█	█	█	█	█	█	68
QA6ASRD040NF41S06	█	█	█	█	█	█	68
QA6ASRD055NF41S08	█	█	█	█	█	█	68
QA8ASRD040NF41S06	█	█	█	█	█	█	69
QA8ASRD055NF41S08	█	█	█	█	█	█	69
QA8ASRD070NF41S08	█	█	█	█	█	█	69
QA8ASRD090NF41S08	█	█	█	█	█	█	69
QA8ASRD115NF41S08	█	█	█	█	█	█	69
QA8ASRD150NF41S08	█	█	█	█	█	█	69
QA8ASRD180NF41S08	█	█	█	█	█	█	69

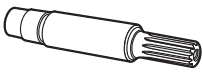



Pulse Tools

Torque Selection Guide

Non Shut-Off Trigger Start	Model	0	47 Nm	94 Nm	141 Nm	188 Nm	235 Nm	Referral Page
		▼	▼	▼	▼	▼	▼	
	100PQ1	[Bar chart showing torque range from 0 to 47 Nm]						71
	Q70PQ1	[Bar chart showing torque range from 0 to 94 Nm]						70
	Q70P3	[Bar chart showing torque range from 0 to 94 Nm]						70
	Q80PQ1	[Bar chart showing torque range from 0 to 141 Nm]						70
	Q80P3	[Bar chart showing torque range from 0 to 141 Nm]						70
	Q90P3	[Bar chart showing torque range from 0 to 141 Nm]						70
	Q110P4	[Bar chart showing torque range from 0 to 188 Nm]						70
	140P6	[Bar chart showing torque range from 0 to 235 Nm]						71

Non Shut-Off Inline Lever Start	Model	0	3 Nm	6 Nm	9 Nm	12 Nm	15 Nm	Referral Page
		▼	▼	▼	▼	▼	▼	
	100SQ1	[Bar chart showing torque range from 0 to 12 Nm]						71

Non Shut-Off Angle Lever Start	Model	0	10 Nm	20 Nm	30 Nm	40 Nm	50 Nm	Referral Page
		▼	▼	▼	▼	▼	▼	
	500A	[Bar chart showing torque range from 0 to 30 Nm]						71
	700A	[Bar chart showing torque range from 0 to 40 Nm]						71

Electric Screwdrivers

Inline

Micro Electric Screwdrivers

ESD protection in an ergonomic space-saving package.

Features

- Torque Range: 0.18 – 3.5 in-lbs (0.02 – 0.40 Nm)
- Speeds: 600 – 1,000 rpm
- 40 V DC from controller (ECM24N)
- Electro-static discharge (ESD) models offer added protection for sensitive electronic assembly applications
- Extremely lightweight and compact ergonomic design
- Variable speed and soft-start features built into controller
- Detachable 1.5 m cable, hanger bail, and two bits included
- Recommended for low-torque applications requiring additional ESD protection along with precise torque and speed control



Service and Accessories

Manuals:

- 45549169
- 45549144
- 45549177

Controller Manuals:

- 45549193
- 45549185
- 45549201

Accessories:

- Balancer
- Shaker box
- Bits

Model	V	in-lbs (Nm)	in-lbs (Nm)	rpm	in-lbs	lb (kg)	in (mm)	Controller Required
DC INCLINE LEVER START								
ELM0107N	40 V DC	0.18 – 0.62 (0.02 – 0.07)	0.35 – 1.77 (0.04 – 0.20)	750	0.51 (0.23)	6.52" (165.5)	0.16" (4.0)	ECM24N
ELM0110N	40 V DC	0.18 – 0.62 (0.02 – 0.07)	0.35 – 1.77 (0.04 – 0.20)	1,000	0.51 (0.23)	6.52" (165.5)	0.16" (4.0)	ECM24N
ELM0306N	40 V DC	1.33 – 3.54 (0.15 – 0.40)	–	600	0.51 (0.23)	6.52" (165.5)	0.16" (4.0)	ECM24N

Model	Input Voltage	Output Voltage	lb (kg)	in (mm)	Soft Start	Speed Adjust	Controller Required
CONTROLLER							
ECM24N	115 V AC	40 V DC	1.98 (0.90)	5.9" x 3.6" x 2.1" (150 x 91 x 52)	YES	YES	YES

Electric Screwdrivers

Inline

Low-Torque Versatec ESD

ESD protection in an award-winning ergonomic package.



EL1007B

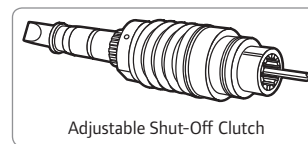

Features

- Torque Range: 1.7 – 10.4 in-lbs (0.19 – 1.2 Nm)
- Speeds: 500 – 1,000 rpm
- 24 V DC from ESD controller (EC24N-ESD)
- Electro-static discharge (ESD) models offer added protection for sensitive electronic assembly applications
- Variable speed and soft-start features built into controller
- Lightweight, compact design
- Clean room-rated
- Vacuum pickup ready
- Soft stop models minimize failures to sensitive equipment by limiting the motor inertia as the clutch begins to shut off
- Recommended for low-torque applications requiring additional ESD protection along with precise torque and speed control

Service and Accessories

Manuals:

- 16574683
- 16578692
- 16575367

Controller Manuals:

- 45532066
- 45532041
- 45532058

Accessories:

- Balancer
- Shaker box
- Bits

Model	V	in-lbs (Nm)	1 min. rpm	in-lbs	lb (kg)	in (mm)	Controller Required
EL1007BC-ESD	24 V DC	1.7 – 10.4 (0.19 – 1.2)	700 – 1000	0.77 (0.35)	10.5" (267)	1/4"	EC24N-ESD
EL0410BC-SS-ESD	24 V DC	1.7 – 3.5 (0.2 – 0.4)	700 – 1000	0.77 (0.35)	10.5" (267)	0.16" (4.0)	EC24N-ESD
EL0510BC-SS-ESD	24 V DC	1.7 – 3.5 (0.2 – 0.4)	700 – 1000	0.77 (0.35)	10.5" (267)	0.16" (4.0)	EC24N-ESD
EL0807BC-SS-ESD	24 V DC	1.7 – 3.5 (0.2 – 0.4)	700 – 1000	0.77 (0.35)	10.5" (267)	0.16" (4.0)	EC24N-ESD
EL1007BC-SS-ESD	24 V DC	1.7 – 3.5 (0.2 – 0.4)	700 – 1000	0.77 (0.35)	10.5" (267)	0.16" (4.0)	EC24N-ESD

Model	Input Voltage	Output Voltage	lb (kg)	in (mm)	Soft Start	Speed Adjust	Controller Required
CONTROLLER							
EC24N-ESD	115 V AC	24 V DC	5.1 (2.31)	10.5" x 3.3" x 4.1" (267 x 83 x 104)	YES	YES	YES

Low-Torque Versatec

Sets the standards for ergonomics and operator convenience.

Features

- Torque Range: 0.26 – 10.4 in-lbs (0.03 – 1.2 Nm)
- Speeds: 500 – 1,000 rpm
- 24 V DC from controller (EC24N)
- Ergonomic package features contoured soft-touch grip, two-finger lever actuation, and easy forward reverse control providing the ultimate in operator comfort and productivity
- Variable speed and soft-start features built into controller
- Lightweight, compact design
- Externally adjustable torque control
- Clean room models available without soft-touch grip
- Two bits, 1.5 m cable, and hanger bail included
- Recommended for low-torque applications requiring precise torque and speed control

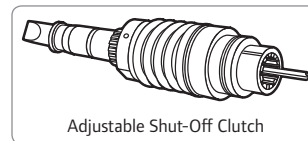

Service and Accessories

Manuals:

- 45530128
- 45527595
- 45530136

Controller Manuals:

- 45532066
- 45532041
- 45532058

Accessories:

- Balancer
- Shaker box
- Bits

Model	V	in-lbs (Nm)	1 min. rpm	in-lbs	lb (kg)	in (mm)	Controller Required
INLINE LEVER START							
EL0109B	24 V DC	0.26 – 1.30 (0.03 – 0.15)	650 – 950	0.7 (0.32)	9.25" (235)	0.16" (4.0)	EC24N
EL0410B	24 V DC	0.44 – 4.79 (0.05 – 0.54)	750 – 1000	0.8 (0.32)	9.25" (235)	1/4"	EC24N
EL1007B*	24 V DC	0.5 – 10.44 (0.06 – 1.2)	500 – 700	0.8 (0.32)	9.25" (235)	1/4"	EC24N
INLINE LEVER START CLEAN ROOM							
EL0410BC	24 V DC	0.44 – 4.79 (0.05 – 0.54)	750 – 1000	0.8 (0.32)	9.25" (235)	1/4"	EC24N
EL1007BC*	24 V DC	0.5 – 10.44 (0.06 – 1.2)	500 – 700	0.8 (0.32)	9.25" (235)	1/4"	EC24N

*Two clutch springs are furnished to cover torque range.
Tool is shipped with heavier clutch spring installed.

Model	Input Voltage	Output Voltage	lb (kg)	in (mm)	Soft Start	Speed Adjust	Controller Required
CONTROLLER							
EC24N	115 V AC	24 V DC	5.1 (2.31)	10.5" x 3.3" x 4.1" (267 x 83 x 104)	YES	YES	NO

Electric Screwdrivers

Inline

Low-Torque ES Series

Proven performance in an economical package.

Features

- Torque Range: 0.4 – 9.0 in-lbs (0.05 – 1.0 Nm)
- Speeds: 500 – 900 rpm
- 24 V DC from controller (ESCB50)
- Precise torque control for more efficient and accurate production
- Variable speed and soft-start features built into controller
- Externally adjustable torque control
- Clean room models available
- Two bits, 1.5 m cable, and hanger bail included
- Recommended for low-torque applications requiring precise torque and speed control

Service and Accessories

Manuals:

- 45527777
- 45527702
- 45527801

Controller Manuals:

- 45532090
- 45532074
- 45532082

Accessories:

- Balancer
- Shaker box
- Bits



ES50T & ESCB50

Adjustable Shut-Off Clutch

Model	V	in-lbs (Nm)	in-lbs (Nm)	rpm	lbs (kg)	in (mm)	in	Controller Required
DC INLINE LEVER START								
ES45T	24 V DC	0.5 – 4.7 (0.06 – 0.53)	1.7 – 6.0 (0.19 – 0.68)	600 – 900	0.75 (0.34)	8.87" (225)	1/4"	ESCB50
ES50T	24 V DC	0.4 – 4.7 (0.05 – 0.53)	2.0 – 9.0 (0.23 – 1.02)	500 – 650	0.75 (0.34)	8.88" (226)	1/4"	ESCB50
DC INLINE CLEAN ROOM LEVER START								
ES50TC	24 V DC	0.4 – 4.7 (0.05 – 0.53)	2.0 – 9.0 (0.23 – 1.02)	500 – 650	0.88 (0.40)	10.50" (267)	1/4"	ESCB50

Model	Input Voltage	Output Voltage	lb (kg)	in (mm)	Soft Start	Speed Adjust
CONTROLLER						
ESCB50	115 V AC	24 V DC	4.4 (1.9)	6.8" x 5.8" x 4.3" (171 x 146 x 108)	YES	YES

High-Torque Brushless



Brushless design provides accuracy and increased durability.

Features

- Torque Range: 3.5 – 26.5 in-lbs (0.4 – 3.0 Nm)
- Speeds: 1,200 – 2,000 rpm
- 115 V AC plug in with integral 3 m cable
- Excellent accuracy and durability resulting from improved clutch and brushless motor design
- Wide torque range allows expanded application coverage from a single tool
- Ergonomic soft-touch grip improves operator comfort
- RoHS-compliant
- Bit, hanger bail, and low-torque spring included
- Recommended for higher duty cycle applications where precise torque control is required

Service and Accessories





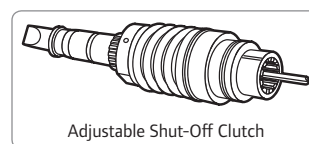

Manuals:

-  45549128
-  45549110
-  45549136

Accessories:

- Balancer
- Shaker box
- Bits
- Pistol grip handle: DLW2100TP



Model	V	in-lbs (Nm)	in-lbs (Nm)	rpm	lbs (kg)	in (mm)	in
 INLINE PUSH-TO- START							
EPB2612N	115 V AC	3.54 – 14.16 (0.4 – 1.6)	10.62 – 26.55 (1.2 – 3.0)	1,200	1.54 (0.7)	10.9" (276)	1/4" 
EPB2620N	115 V AC	3.54 – 14.16 (0.4 – 1.6)	10.62 – 26.55 (1.2 – 3.0)	2,000	1.54 (0.7)	10.9" (276)	1/4" 
 INLINE LEVER START							
ELB2612N	115 V AC	3.54 – 14.16 (0.4 – 1.6)	10.62 – 26.55 (1.2 – 3.0)	1,200	1.54 (0.7)	10.9" (276)	1/4" 
ELB2620N	115 V AC	3.54 – 14.16 (0.4 – 1.6)	10.62 – 26.55 (1.2 – 3.0)	2,000	1.54 (0.7)	10.9" (276)	1/4" 

Electric Screwdrivers

Inline / Pistol

High-Torque Versatec



Sets the standards for ergonomics and operator convenience.

Features

- Torque Range: 5.0 – 40.0 in-lbs (0.6 – 4.5 Nm)
- Speeds: 300 – 2,000 rpm
- 115 V AC plug in with detachable 8 foot cable
- Ergonomic package features contoured soft-touch grip, two-finger lever actuation, and easy forward reverse control providing the ultimate in operator comfort and productivity
- Removable contoured flange and torque adjustment cover protects torque setting while giving instant visible confirmation in readout window
- Brush replacement light signals when maintenance is required
- Dual position cord allows 90 degree connector rotation for optimal cable routing
- Two bits, two brushes, and hanger bail included
- Recommended for applications where precise torque control is required

Service and Accessories

Manuals:

-  45530102
-  45527579
-  45530110

Accessories:







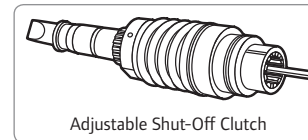





- Balancer
- Shaker box
- Bits
- Pistol grip handle; EP4007N-48
- Torque adjusting wrench



EP4007N



Adjustable Shut-Off Clutch

Model	V	in-lbs (Nm)	rpm	lbs (kg)	in (mm)	in
DC INLINE PUSH-TO-START						
EP1520N	115 V AC	5.0 – 15.0 (0.6 – 1.7)	2,000	1.6 (0.73)	11.25" (286)	1/4" 
EP1510N	115 V AC	5.0 – 15.0 (0.6 – 1.7)	1,000	1.6 (0.73)	11.25" (286)	1/4" 
EP2612N	115 V AC	11.0 – 26.0 (1.2 – 2.9)	1,200	1.6 (0.73)	11.25" (286)	1/4" 
EP2607N	115 V AC	11.0 – 26.0 (1.2 – 2.9)	700	1.6 (0.73)	11.25" (286)	1/4" 
EP2603N	115 V AC	11.0 – 26.0 (1.2 – 2.9)	300	1.6 (0.73)	11.25" (286)	1/4" 
DC INLINE LEVER START						
EL1520N	115 V AC	5.0 – 15.0 (0.6 – 1.7)	2,000	1.63 (0.74)	11.25" (286)	1/4" 
EL1510N	115 V AC	5.0 – 15.0 (0.6 – 1.7)	1,000	1.63 (0.74)	11.25" (286)	1/4" 
EL2612N	115 V AC	11.0 – 26.0 (1.2 – 2.9)	1,200	1.63 (0.74)	11.25" (286)	1/4" 
EL2607N	115 V AC	11.0 – 26.0 (1.2 – 2.9)	700	1.63 (0.74)	11.25" (286)	1/4" 
EL2603N	115 V AC	11.0 – 26.0 (1.2 – 2.9)	300	1.63 (0.74)	11.25" (286)	1/4" 
DC TRIGGER START WITH PISTOL ATTACHMENT						
ET4007N	115 V AC	18.0 – 40.0 (2.0 – 4.5)	700	1.83 (0.83)	11.25" (286)	1/4" 
DC PUSH-TO-START WITH PISTOL ATTACHMENT						
EP4007N	115 V AC	18.0 – 40.0 (2.0 – 4.5)	700	1.83 (0.83)	11.25" (286)	1/4" 

High-Torque ES Series

Proven performance in an economical package.

Features

- Torque Range: 4.0 – 40.0 in-lbs (0.5 – 4.5 Nm)
- Speeds: 400 – 2,000 rpm
- 115 V AC plug in with integral 3 m cable
- Precise torque control for more efficient and accurate production
- Two bits, two brushes, and hanger bail included
- Recommended for applications where precise torque control is required

Service and Accessories

Manuals:

 45527751

 45527611

 45527785

Accessories:



















Balancer

Shaker box

Bits

Pistol grip handle: DLW2100TP



Model	 V	 in-lbs (Nm)	 1 min. rpm	 lbs (kg)	 in (mm)	 in
 INLINE PUSH-TO-START						
ES90P	115 V AC	4.4 – 16.0 (0.5 – 1.8)	2,000	1.50 (0.68)	10.00" (254)	1/4" 
ES60P	115 V AC	4.4 – 17.0 (0.5 – 1.9)	1,000	1.50 (0.68)	10.00" (254)	1/4" 
ES80P	115 V AC	12.0 – 24.0 (1.4 – 2.7)	1,200	1.50 (0.68)	10.00" (254)	1/4" 
ES70P	115 V AC	10.0 – 26.0 (1.1 – 2.9)	700	1.50 (0.68)	10.00" (254)	1/4" 
 INLINE LEVER START						
ES90T	115 V AC	4.4 – 16.0 (0.5 – 1.8)	2,000	1.53 (0.69)	10.00" (254)	1/4" 
ES60T	115 V AC	4.4 – 17.0 (0.5 – 1.9)	1,000	1.53 (0.69)	10.00" (254)	1/4" 
ES70T	115 V AC	10.0 – 26.0 (1.1 – 2.9)	700	1.53 (0.69)	10.00" (254)	1/4" 
 TRIGGER START WITH PISTOL ATTACHMENT						
ES100T	115 V AC	15.0 – 40.0 (1.9 – 4.5)	400	1.68 (0.76)	10.00" (254)	1/4" 
 PUSH-TO-START WITH PISTOL ATTACHMENT						
ES100P	115 V AC	15.0 – 40.0 (1.9 – 4.5)	400	1.68 (0.76)	10.00" (254)	1/4" 

Electric Screwdrivers

Angle

High-Torque Versatec

Sets the standards for ergonomics and operator convenience.



EL1510N2S5

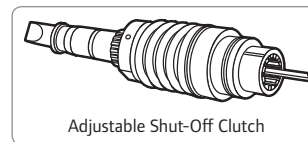

Adjustable Shut-Off Clutch

Features

- Torque Range: 5.0 – 60.0 in-lbs (0.6 – 6.8 Nm)
- Speeds: 450 – 1,850 rpm
- 115 V AC plug in with detachable 8 foot cable
- Ergonomic package features contoured soft-touch grip, two-finger lever actuation, and easy forward reverse control providing the ultimate in operator comfort and productivity
- Removable contoured flange and torque adjustment cover protects torque setting while giving instant visible confirmation in readout window
- Brush replacement light signals when maintenance is required
- Dual-position cord allows optimal cable routing
- Small angleheads designed for close quarter applications
- Angleheads rotate 360 degrees
- Two bits, two brushes, and hanger bail included
- Recommended for applications where precise torque control is required

Service and Accessories

Manuals:

- 45530102
- 45527579
- 45530110

Accessories:

- Extension cord
- Balancer
- Pistol grip handle: EP4007N-48
- Sockets, see form # IR-0506-016

Model	V	in-lbs (Nm)	rpm	lbs (kg)	in (mm)	in (mm)	in (mm)	in
DC LEVER START LARGE ANGLE HEAD								
EL1510N2S5	115 V AC	8 – 23 (0.9 – 2.6)	650	2.20 (1.00)	17.64" (448)	0.52" (13.21)	1.73" (43.94)	1/4" □
EL2612N2S5	115 V AC	17 – 40 (1.9 – 4.5)	800	2.20 (1.00)	17.64" (448)	0.52" (13.21)	1.73" (43.94)	1/4" □
ET4007N2S5	115 V AC	27 – 60 (3.0 – 6.8)	450	2.20 (1.00)	17.64" (448)	0.52" (13.21)	1.73" (43.94)	1/4" □
EL1510N2S3	115 V AC	8 – 23 (0.9 – 2.6)	650	2.20 (1.00)	17.64" (448)	0.52" (13.21)	1.73" (43.94)	1/4" ○
EL2612N2S3	115 V AC	17 – 40 (1.9 – 4.5)	800	2.20 (1.00)	17.64" (448)	0.52" (13.21)	1.73" (43.94)	1/4" ○
ET4007N2S3	115 V AC	27 – 60 (3.0 – 6.8)	450	2.20 (1.00)	17.64" (448)	0.52" (13.21)	1.73" (43.94)	1/4" ○
DC LEVER START SMALL ANGLE HEAD								
EL1520N1S5*	115 V AC	5 – 15 (0.6 – 1.7)	1,850	2.00 (0.91)	17.45" (443)	0.33" (8.38)	1.47" (37.34)	1/4" □
EL1510N1S5*	115 V AC	5 – 15 (0.6 – 1.7)	950	2.00 (0.91)	17.45" (443)	0.33" (8.38)	1.47" (37.34)	1/4" □
EL2612N1S5*	115 V AC	11 – 26 (1.2 – 2.9)	1,100	2.00 (0.91)	17.45" (443)	0.33" (8.38)	1.47" (37.34)	1/4" □

*This head is designed for close-quarter applications. Not intended for extensive counterclockwise use. Angle heads can rotate 360 degrees for application adjustment. Torque output will vary with application.

High-Torque ES Series

Proven performance in an economical package.

Features

- Torque Range: 4.0 – 56.0 in-lbs (0.45 – 6.3 Nm)
- Speeds: 250 – 1,850 rpm
- 115 V AC plug in with integral 3 m cable
- Precise torque control for more efficient and accurate production
- Small angleheads designed for close-quarter applications
- Angleheads rotate 360 degrees
- Two bits, two brushes, and hanger bail included
- Recommended for applications where precise torque control is required



ES70T2S3

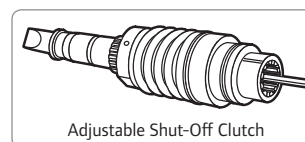

Adjustable Shut-Off Clutch

Service and Accessories

Manuals:

- 45527769
- 45527678
- 45527793

Accessories:

- Balancer
- Pistol grip handle; EP4007N-48
- Sockets, see form # IR-0506-016

Model	V	in-lbs (Nm)	1 min. rpm	lbs (kg)	in (mm)	in (mm)	in (mm)	in
DC LEVER START LARGE ANGLE HEAD								
ES90T2S3	115 V AC	6 – 19 (0.68 – 2.2)	1,300	2.1 (0.95)	16.89" (429)	0.52" (13.21)	1.99" (50.55)	1/4"
ES60T2S3	115 V AC	6 – 23 (0.68 – 2.6)	650	2.1 (0.95)	16.89" (429)	0.52" (13.21)	1.99" (50.55)	1/4"
ES70T2S3	115 V AC	11 – 36 (1.2 – 4.1)	450	2.1 (0.95)	16.89" (429)	0.52" (13.21)	1.99" (50.55)	1/4"
ES100T2S3	115 V AC	14 – 56 (1.6 – 6.3)	250	2.1 (0.95)	16.89" (429)	0.52" (13.21)	1.99" (50.55)	1/4"
ES90T2S5	115 V AC	6 – 19 (0.68 – 2.2)	1,300	2.1 (0.95)	16.89" (429)	0.52" (13.21)	1.73" (43.94)	1/4"
ES60T2S5	115 V AC	6 – 23 (0.68 – 2.6)	650	2.1 (0.95)	16.89" (429)	0.52" (13.21)	1.73" (43.94)	1/4"
ES70T2S5	115 V AC	11 – 36 (1.2 – 4.1)	450	2.1 (0.95)	16.89" (429)	0.52" (13.21)	1.73" (43.94)	1/4"
ES100T2S5	115 V AC	14 – 56 (1.6 – 6.3)	250	2.1 (0.95)	16.89" (429)	0.52" (13.21)	1.73" (43.94)	1/4"
DC LEVER START SMALL ANGLE HEAD								
ES90T1S5	115 V AC	4 – 14 (0.45 – 1.6)	1,850	1.9 (0.86)	16.70" (424)	0.33" (8.38)	1.47" (37.34)	1/4"
ES60T1S5	115 V AC	4 – 17 (0.45 – 1.9)	950	1.9 (0.86)	16.70" (424)	0.33" (8.38)	1.47" (37.34)	1/4"
ES70T1S5	115 V AC	8 – 26 (0.90 – 2.9)	650	1.9 (0.86)	16.70" (424)	0.33" (8.38)	1.47" (37.34)	1/4"

Electric Screwdrivers

Accessories

Torque Adjustment Covers

Part Number	Description	For Use With
ES60T-675	Torque Adjustment Cover	ES60, ES70, ES80, ES90, ES100
EL0410BC-46	Torque Adjustment Cover	Low-Torque VersaTec
EL0410BC-46-ESD	Torque Adjustment Cover	Low-Torque VersaTec-ESD

Suspension Bails

Part Number	Description	For Use With
EP4007N-365	Vertical Suspension Bail	High-Torque VersaTec
EP4007N-366	Horizontal Suspension Bail	High-Torque VersaTec
EL0109B-365	Vertical Suspension Bail	Low-Torque VersaTec
DAA40-A366	Horizontal Hanger	Electric angle screwdrivers

Power and Extension Cords

Part Number	Description	For Use With
EL0109B-239	Power Cord Assembly	High-Torque VersaTec
ES40T-249	Power Cord Assembly	Low-Torque VersaTec
EP4007N-239-C6A	6' Coiled Extension Cord	High-Torque VersaTec
EP4007N-239-8A	8' Coiled Extension Cord	High-Torque VersaTec
EP4007N-239-12A	12' Coiled Extension Cord	High-Torque VersaTec
EP4007N-239-25	25' Coiled Extension Cord	High-Torque VersaTec
ES40T-249-2	6.5' Extension Cord	Low-Torque ES and VersaTec

Other Accessories

Part Number	Description	Shape	For Use With
EP4007N-516	Torque Adjusting Wrench	N/A	VersaTec Models
DLW3402	Plastic Screw Shaker Box	5-1/2" x 3-7/8"	Screw sizes 0 – 2 mm (0.07" – 0.08")
DLW3602	Plastic Screw Shaker Box	5-1/2" x 3-7/8"	Screw sizes 1 – 4 mm (0.08" – 0.11")
DLW3802	Plastic Screw Shaker Box	6-11/16" x 4-7/8"	Screw sizes 3 – 8 mm (0.12" – 0.16")



Pistol Attachment

Part Number	Description	For Use With
EP4007N-48	Attached Pistol Grip Handle	High-Torque VersaTec
DLW2100TP	Attached Pistol Grip Handle	ES60, ES70 ES80, ES90, EPB, ELB

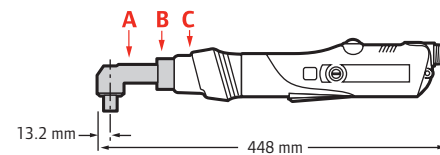

Angle Head Conversion

Component	Part Number	Description
A	3RL23	1/4" Quick Change
A	3RL25	1/4" Square Drive
B	EL4007N2S5-AHC	Coupling Nut
C	ET4007N2S5-580	Clutch Cover

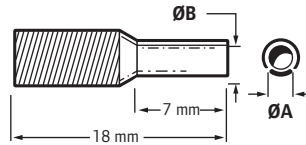

Vacuum Pick-Up Sleeves

Part Number	Complementing Bit Part Number	"A" Inside Diameter in (mm)	"B" Outside Diameter in (mm)
DLS2120	DLB2122-10	0.079" (2.0)	0.138" (3.5)
DLS2122	DLB2122-10	0.098" (2.5)	0.138" (3.5)
DLS2123	DLB2122-10	0.106" (2.7)	0.138" (3.5)
DLS2124	DLB2122-10	0.122" (3.1)	0.138" (3.5)
DLS2125	DLB2124-10	0.130" (3.3)	0.177" (4.5)
DLS2126	DLB2124-10	0.138" (3.5)	0.177" (4.5)
DLS2127	DLB2124-10	0.146" (3.7)	0.177" (4.5)
DLS2128	DLB2126-10	0.158" (4.0)	0.177" (4.5)
DLS2129	DLB2126-10	0.165" (4.2)	0.212" (5.5)
DLS2130	DLB2126-10	0.177" (4.5)	0.212" (5.5)
DLS2131	DLB2128-10, DLB2130-10, XP161, XRP161	0.185" (4.7)	0.212" (5.5)
DLS2132	DLB2128-10, DLB2130-10, XP161, XRP161	0.201" (5.1)	0.212" (5.5)
DLS2133	DLB2128-10, DLB2130-10, XP161, XRP161	0.209" (5.3)	0.256" (6.5)
DLS2134	DLB2128-10, DLB2130-10, XP161, XRP161	0.221" (5.6)	0.256" (6.5)
EL0410BC-53	DLB2128-10, DLB2130-10, XP161, XRP161	0.240" (6.1)	0.276" (7.0)

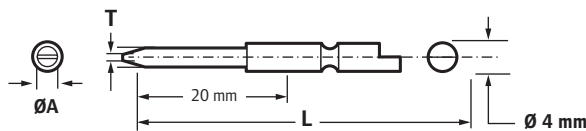

Slot Bits

Part Number	"T" Size in	"A" Diameter in (mm)	"L" Length in	Screw Size Range	Qty
DLB2220-10	0.012"	0.079" (2.0)	1.7"	00-0	10
DLB2221-10	0.012"	0.098" (2.5)	1.7"	00-0	10
DLB2222-10	0.016"	0.117" (3.0)	1.7"	0-2	10
DLB2223-10	0.02"	0.157" (4.0)	1.7"	2-4	10
DLB2224-10	0.026"	0.197" (5.0)	1.7"	3-5	10

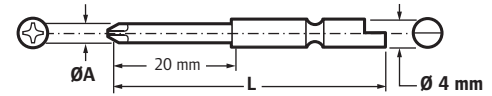

Phillips Bits

Part Number	Point Size	"A" Diameter in (mm)	"L" Length in	Screw Size Range	Qty
DLB2120-10	0	0.071" (1.8)	1.7"	0-1	10
DLB2121-10	0	0.071" (1.8)	2.5"	0-1	10
DLB2122-10	0	0.079" (2.0)	1.7"	00-0	10
DLB2123-10	0	0.079" (2.0)	2.5"	00-0	10
DLB2124-10	0	0.098" (2.5)	1.7"	0-1	10
DLB2125-10	0	0.098" (2.5)	2.5"	0-1	10
DLB2126-10	1	0.118" (3.0)	1.7"	2-4	10
DLB2127-10	1	0.118" (3.0)	2.5"	2-4	10
DLB2128-10	1	0.157" (4.0)	1.7"	2-4	10
DLB2129-10	1	0.157" (4.0)	2.5"	2-4	10
DLB2130-10	2	0.157" (4.0)	1.7"	5-10	10
DLB2131-10	2	0.157" (4.0)	2.5"	5-10	10
DLB2132-10	3	0.236" (6.0)	1.7"	10-1/4	10

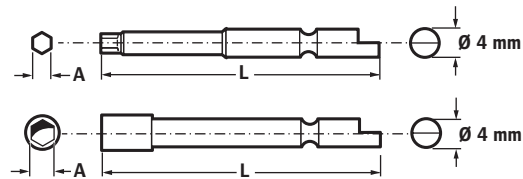

Hexagon, Male and Female

Part Number	Screw Size	"A" Hex Size in (mm)	"L" Length in	Use Diagram	Qty
DLB2321-10	0.12	0.059" (1.5)	1.7"	Male	10
DLB2322-10	0.16	0.079" (2.0)	1.7"	Male	10
DLB2323-10	0.24	0.118" (3.0)	1.7"	Male	10
DLB2324-10	0.31	0.157" (4.0)	1.7"	Male	10
DLB2420-10	N/A	0.091" (2.3)	1.7"	Female	10
DLB2421-10	N/A	0.098" (2.5)	1.7"	Female	10
DLB2422-10	N/A	0.118" (3.0)	1.7"	Female	10
DLB2423-10	0.08	0.157" (4.0)	1.7"	Female	10
DLB2424-10	0.09	0.177" (4.5)	1.7"	Female	10
DLB2425-10	0.1	0.197" (5.0)	1.7"	Female	10
DLB2426-10	0.12	0.217" (5.5)	1.7"	Female	10

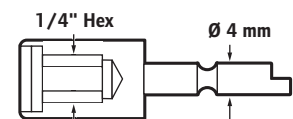

Insert Bit Holders

Part Number	Description	For Use With
DLW-4100	Slotted Bit Holder	EL0109B / "Micro" / SS-ESD

Pistol Grip Air Screwdrivers

Adjustable Shut-Off Clutch

Q2 Series

Sets the standard for assembly tool ergonomics.

Features

- Torque range: 3.0 – 47.8 in-lbs (0.3 – 5.4 Nm)
- Speeds: 250 – 2,000 rpm
- Compact, lightweight, well-balanced design
- Contoured soft grip handle
- Two-finger trigger distributes grip force and reduces stress
- Top or bottom air inlets allow for optimal mounting
- Interchangeable handles offer custom fit for various hand sizes
- Recommended for applications where precise torque control is required



Service and Accessories

Manuals:

- 16574527
- 80165939
- 16575219

Accessories:

- Torque arm: QTA010
- Spring balancer
- Spindle accessories
- Hanger: TRP-A365

Kits:

- Inlet / throttle / motor tune-up kit: Q2PFAST-TK1
- ASO clutch tune-up kit: Q2-ASO-TK1



























Model	in-lbs (Nm)	in-lbs (Nm)	in-lbs (Nm)	rpm	lbs (kg)	in (mm)	in (mm)	in	cfm (L/Min)
OC PUSH-TO-START									
QP1P20S1D	2.7 – 9.7 (0.3 – 1.1)	8.0 – 22.1 (0.9 – 2.5)	–	2,000	1.9 (0.8)	8.8" (223)	0.6" (15)	1/4"	16 (450)
QP1P10S1D	2.7 – 9.7 (0.3 – 1.1)	8.0 – 27.3 (0.9 – 3.1)	13.3 – 39.8 (1.5 – 4.5)	1,000	1.9 (0.8)	8.8" (223)	0.6" (15)	1/4"	16 (450)
QP1P10S1TD*	2.7 – 9.7 (0.3 – 1.1)	8.0 – 27.3 (0.9 – 3.1)	13.3 – 39.8 (1.5 – 4.5)	1,000	1.9 (0.8)	8.8" (223)	0.6" (15)	1/4"	16 (450)

*Top air inlet.



(continued next page)

Series			
Q2	75 dBa	1/4" NPT	1/4" (6 mm)

Q2 Series (continued)

Model	 in-lbs (Nm)	 in-lbs (Nm)	 in-lbs (Nm)	 rpm	 lbs (kg)	 in (mm)	 in (mm)	 in	 cfm (L/Min)
DC TRIGGER START									
QP1S20S1D	2.7 – 9.7 (0.3 – 1.1)	8.0 – 22.1 (0.9 – 2.5)	–	2,000	1.9 (0.8)	8.8" (223)	0.6" (15)	1/4" 	16 (450)
QP1S20S1TD*	2.7 – 9.7 (0.3 – 1.1)	8.0 – 22.1 (0.9 – 2.5)	–	2,000	1.9 (0.8)	8.8" (223)	0.6" (15)	1/4" 	16 (450)
QP1S10S1D	2.7 – 9.7 (0.3 – 1.1)	8.0 – 27.3 (0.9 – 3.1)	13.3 – 39.8 (1.5 – 4.5)	1,000	1.9 (0.8)	8.8" (223)	0.6" (15)	1/4" 	16 (450)
QP1S10S1TD*	2.7 – 9.7 (0.3 – 1.1)	8.0 – 27.3 (0.9 – 3.1)	13.3 – 39.8 (1.5 – 4.5)	1,000	1.9 (0.8)	8.8" (223)	0.6" (15)	1/4" 	16 (450)
QP1S05S1D	2.7 – 9.7 (0.3 – 1.1)	8.0 – 28.3 (0.9 – 3.2)	13.3 – 47.8 (1.5 – 5.4)	500	1.9 (0.8)	8.8" (223)	0.6" (15)	1/4" 	16 (450)
QP1S05S1TD*	2.7 – 9.7 (0.3 – 1.1)	8.0 – 28.3 (0.9 – 3.2)	13.3 – 47.8 (1.5 – 5.4)	500	1.9 (0.8)	8.8" (223)	0.6" (15)	1/4" 	16 (450)
QP1S02S1TD*	2.7 – 9.7 (0.3 – 1.1)	8.0 – 28.3 (0.9 – 3.2)	13.3 – 47.8 (1.5 – 5.4)	250	1.9 (0.8)	8.8" (223)	0.6" (15)	1/4" 	16 (450)
DC TRIGGER + PUSH-TO-START									
QP1T20S1D	2.7 – 9.7 (0.3 – 1.1)	8.0 – 22.1 (0.9 – 2.5)	–	2,000	1.9 (0.8)	8.8" (223)	0.6" (15)	1/4" 	16 (450)
QP1T20S1TD*	2.7 – 9.7 (0.3 – 1.1)	8.0 – 22.1 (0.9 – 2.5)	–	2,000	1.9 (0.8)	8.8" (223)	0.6" (15)	1/4" 	16 (450)
QP1T10S1D	2.7 – 9.7 (0.3 – 1.1)	8.0 – 27.3 (0.9 – 3.1)	13.3 – 39.8 (1.5 – 4.5)	1,000	1.9 (0.8)	8.8" (223)	0.6" (15)	1/4" 	16 (450)
QP1T10S1TD*	2.7 – 9.7 (0.3 – 1.1)	8.0 – 27.3 (0.9 – 3.1)	13.3 – 39.8 (1.5 – 4.5)	1,000	1.9 (0.8)	8.8" (223)	0.6" (15)	1/4" 	16 (450)
QP1T10S3D	2.7 – 9.7 (0.3 – 1.1)	8.0 – 27.3 (0.9 – 3.1)	13.3 – 39.8 (1.5 – 4.5)	1,000	1.9 (0.8)	8.8" (223)	0.6" (15)	1/4" 	16 (450)
QP1T05S1D	2.7 – 9.7 (0.3 – 1.1)	8.0 – 28.3 (0.9 – 3.2)	13.3 – 47.8 (1.5 – 5.4)	500	1.9 (0.8)	8.8" (223)	0.6" (15)	1/4" 	16 (450)
QP1T05S1TD*	2.7 – 9.7 (0.3 – 1.1)	8.0 – 28.3 (0.9 – 3.2)	13.3 – 47.8 (1.5 – 5.4)	500	1.9 (0.8)	8.8" (223)	0.6" (15)	1/4" 	16 (450)
QP1T05S3D	2.7 – 9.7 (0.3 – 1.1)	8.0 – 28.3 (0.9 – 3.2)	13.3 – 47.8 (1.5 – 5.4)	500	1.9 (0.8)	8.8" (223)	0.6" (15)	1/4" 	16 (450)
QP1T02S1D	2.7 – 9.7 (0.3 – 1.1)	8.0 – 28.3 (0.9 – 3.2)	13.3 – 47.8 (1.5 – 5.4)	250	1.9 (0.8)	8.8" (223)	0.6" (15)	1/4" 	16 (450)
QP1T02S1TD*	2.7 – 9.7 (0.3 – 1.1)	8.0 – 28.3 (0.9 – 3.2)	13.3 – 47.8 (1.5 – 5.4)	250	1.9 (0.8)	8.8" (223)	0.6" (15)	1/4" 	16 (450)

*Top air inlet.

Series			
Q2	75 dBa	1/4" NPT	1/4" (6 mm)

QRT Series

Unique Quick Reverse Touch Control (QRT) trigger makes this the ideal tool when single-hand control of speed and rotation is required.

Features

- Torque range: 3 – 100 in-lbs (0.34 – 11.3 Nm)
- Speeds: 800 – 2,600 rpm
- Simple two-finger reverse control
- Ideal for applications that require frequent reversing or realignment
- Operates as trigger + push-to-start tool in forward rotation
- Reverse trigger provides instant full-power reverse
- Recommended for applications where precise torque control is required

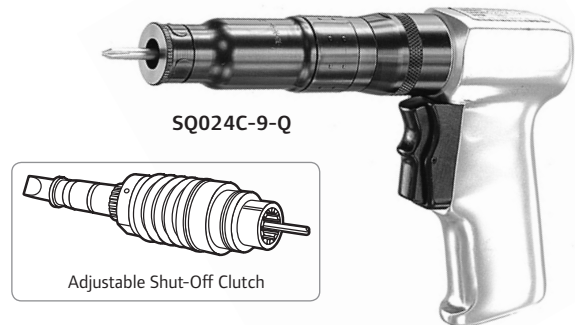

Service and Accessories

Manuals:

49999054 50 Series

Accessories:

Torque arm: QTA010
Spring balancers: BLD2
Spindle accessories

Model	in-lbs (Nm)	in-lbs (Nm)	in-lbs (Nm)	rpm	lbs (kg)	in (mm)	in (mm)	in	cfm (L/Min)
50 SERIES QRT TRIGGER + PUSH-TO-START									
SQ054C-16-Q	15 - 40 (1.7 - 4.5)	25 - 60 (2.8 - 6.8)	-	1,600	3.2 (1.4)	8.8" (224)	0.9" (24)	1/4"	25 (720)
SQ054C-10-Q	15 - 40 (1.7 - 4.5)	25 - 60 (2.8 - 6.8)	35 - 80 (4.0 - 9.0)	1,000	3.2 (1.4)	8.8" (224)	0.9" (24)	1/4"	25 (720)
SQ054C-8-Q	15 - 40 (1.7 - 4.5)	25 - 60 (2.8 - 6.8)	35 - 100 (4.0 - 11.3)	800	3.2 (1.4)	8.8" (224)	0.9" (24)	1/4"	25 (720)

Series			
50 Series QRT	78 dBa	1/4" NPT	5/16" (8 mm)

Pistol Grip Air Screwdrivers

Adjustable Shut-Off Clutch

41 Series

Time-tested design known for its durability and performance.

Features

- Torque range: 15 – 100 in-lbs (1.7 – 11.3 Nm)
- Speeds: 800 – 2,400 rpm
- Skinsulate housing provides comfortable grip surface
- One-handed reverse lever
- Recommended for applications where precise torque control is required

Service and Accessories

Manuals:

- 16574592
- 80167356
- 16575284

Accessories:

- Torque arm: QTA010
- Horizontal hanger: 48934
- Dead handle: 48931
- Spring balancer
- Spindle accessories
- Top air inlet kit (push-to-start): 48995

Kits:

- Mechanism kit: 48804-1



41PA10TSQ4

Adjustable Shut-Off Clutch

Model	in-lbs (Nm)	in-lbs (Nm)	in-lbs (Nm)	rpm	lbs (kg)	in (mm)	in (mm)	in	cfm (L/Min)
TRIGGER START									
41PA24TSQ4	15 – 40 (1.7 – 4.5)	–	–	2,400	2.9 (1.3)	9.4" (239)	0.9" (22)	1/4"	28 (790)
41PA16TSQ4	15 – 40 (1.7 – 4.5)	25 – 60 (2.8 – 6.8)	–	1,600	3.1 (1.4)	9.8" (249)	0.9" (22)	1/4"	28 (790)
41PA10TSQ4	15 – 40 (1.7 – 4.5)	25 – 60 (2.8 – 6.8)	35 – 80 (4.0 – 9.0)	1,000	3.1 (1.4)	9.8" (249)	0.9" (22)	1/4"	28 (790)
41PA8TSQ4	15 – 40 (1.7 – 4.5)	25 – 60 (2.8 – 6.8)	35 – 100 (4.0 – 11.3)	800	3.1 (1.4)	9.8" (249)	0.9" (22)	1/4"	28 (790)
PUSH-TO-START									
41PA24PSQ4	15 – 40 (1.7 – 4.5)	–	–	2,400	2.9 (1.3)	9.4" (239)	0.9" (22)	1/4"	28 (790)
41PA16PSQ4	15 – 40 (1.7 – 4.5)	25 – 60 (2.8 – 6.8)	–	1,600	3.1 (1.4)	9.8" (249)	0.9" (22)	1/4"	28 (790)
41PA10PSQ4	15 – 40 (1.7 – 4.5)	25 – 60 (2.8 – 6.8)	35 – 80 (4.0 – 9.0)	1,000	3.1 (1.4)	9.8" (249)	0.9" (22)	1/4"	28 (790)
41PA8PSQ4	15 – 40 (1.7 – 4.5)	25 – 60 (2.8 – 6.8)	35 – 100 (4.0 – 11.3)	800	3.1 (1.4)	9.8" (249)	0.9" (22)	1/4"	28 (790)
TRIGGER + PUSH-TO-START									
41PA16TPQ4	15 – 40 (1.7 – 4.5)	25 – 60 (2.8 – 6.8)	–	1,600	3.0 (1.36)	9.8" (249)	0.9" (22)	1/4"	28 (790)
41PA10TPQ4	15 – 40 (1.7 – 4.5)	25 – 60 (2.8 – 6.8)	35 – 80 (4.0 – 9.0)	1,000	3.1 (1.4)	9.8" (249)	0.9" (22)	1/4"	28 (790)
41PA8TPQ4	15 – 40 (1.7 – 4.5)	25 – 60 (2.8 – 6.8)	35 – 100 (4.0 – 11.3)	800	3.1 (1.4)	9.8" (249)	0.9" (22)	1/4"	28 (790)

Series			
41	78 dBa	1/4" NPT	5/16" (8 mm)

Q2 Series

Sets the standard for assembly tool ergonomics.

Features

- Torque range: 2.7 – 47.8 in-lbs (0.3 – 5.4 Nm)
- Speeds: 250 – 2,000 rpm
- Compact, lightweight, well-balanced design
- Contoured soft grip handle
- Two-finger trigger distributes grip force and reduces stress
- Interchangeable handles offer custom fit for various hand sizes
- Top or bottom air inlets allow for optimal mounting
- Recommended for applications that require a torque limiting clutch



Service and Accessories

Manuals:

- 16574527
- 80165939
- 16575219

Accessories:

- Horizontal hanger: TRP-A365
- Torque arm: QTA010
- Spring balancers
- Spindle accessories

Kits:

- Inlet / throttle / motor tune-up kit: Q2-PFAST-TK1
- Cushion clutch kit: Q2-CC-TK1

Model	in-lbs (Nm)	in-lbs (Nm)	in-lbs (Nm)	rpm	lbs (kg)	in (mm)	in (mm)	in	cfm (L/Min)
TRIGGER START									
QP1S10C1D	2.7 – 9.7 (0.3 – 1.1)	8.0 – 22.1 (0.9 – 2.5)	13.3 – 39.8 (1.5 – 4.5)	1,000	1.9 (0.8)	8.8" (223)	0.6" (15)	1/4"	16 (450)
QP1S10C1TD*	2.7 – 9.7 (0.3 – 1.1)	8.0 – 22.1 (0.9 – 2.5)	13.3 – 39.8 (1.5 – 4.5)	1,000	1.9 (0.8)	8.8" (223)	0.6" (15)	1/4"	16 (450)
QP1S05C1D	2.7 – 9.7 (0.3 – 1.1)	8.0 – 28.3 (0.9 – 3.2)	13.3 – 47.8 (1.5 – 5.4)	500	1.9 (0.8)	8.8" (223)	0.6" (15)	1/4"	16 (450)
QP1S05C1TD*	2.7 – 9.7 (0.3 – 1.1)	8.0 – 28.3 (0.9 – 3.2)	13.3 – 47.8 (1.5 – 5.4)	500	1.9 (0.8)	8.8" (223)	0.6" (15)	1/4"	16 (450)
QP1S02C1TD*	2.7 – 9.7 (0.3 – 1.1)	8.0 – 28.3 (0.9 – 3.2)	13.3 – 47.8 (1.5 – 5.4)	250	1.9 (0.8)	8.8" (223)	0.6" (15)	1/4"	16 (450)
PUSH-TO-START									
QP1P20C1D	2.7 – 9.7 (0.3 – 1.1)	8.0 – 22.1 (0.9 – 2.5)	–	2,000	1.9 (0.8)	8.8" (223)	0.6" (15)	1/4"	16 (450)
QP1P10C1D	2.7 – 9.7 (0.3 – 1.1)	8.0 – 22.1 (0.9 – 2.5)	13.3 – 39.8 (1.5 – 4.5)	1,000	1.9 (0.8)	8.8" (223)	0.6" (15)	1/4"	16 (450)
QP1P05C1D	2.7 – 9.7 (0.3 – 1.1)	8.0 – 28.3 (0.9 – 3.2)	13.3 – 47.8 (1.5 – 5.4)	500	1.9 (0.8)	8.8" (223)	0.6" (15)	1/4"	16 (450)
TRIGGER + PUSH-TO-START									
QP1T10C1D	2.7 – 9.7 (0.3 – 1.1)	8.0 – 22.1 (0.9 – 2.5)	13.3 – 39.8 (1.5 – 4.5)	1,000	1.9 (0.8)	8.8" (223)	0.6" (15)	1/4"	16 (450)
QP1T10C1TD*	2.7 – 9.7 (0.3 – 1.1)	8.0 – 22.1 (0.9 – 2.5)	13.3 – 39.8 (1.5 – 4.5)	1,000	1.9 (0.8)	8.8" (223)	0.6" (15)	1/4"	16 (450)

*Top air inlet.

Series			
Q2	75 dBa	1/4" NPT	1/4" (6 mm)

Pistol Grip Air Screwdrivers

Adjustable Cushion Clutch

41 Series

Time-tested design known for its durability and performance.

Features

- Torque range: 10 – 100 in-lbs (1.1 – 11.3 Nm)
- Speeds: 800 – 2,500 rpm
- Skinsulate housing provides comfortable grip surface
- One-handed reverse lever
- Recommended for applications that require a torque limiting clutch

Service and Accessories

Manuals:

 P7098US

Accessories:

Torque arm: QTA010
Horizontal hanger: 48934
Dead handle: 48931
Spring balancer
Spindle accessories





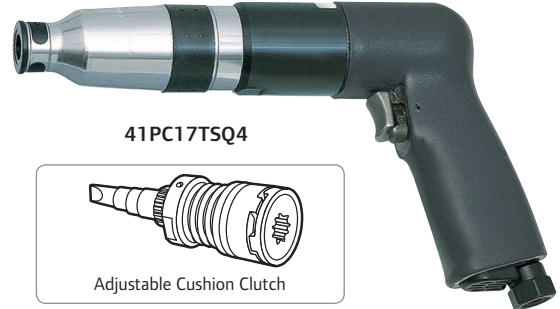







Kits:

Mechanism kit: 48804-1



41PC17TSQ4

Adjustable Cushion Clutch

Model	 in-lbs (Nm)	 in-lbs (Nm)	 in-lbs (Nm)	 rpm	 lbs (kg)	 in (mm)	 in (mm)	 in	 cfm (L/Min)
DC TRIGGER START									
41PC25TSQ4	10–39.8(1.1–4.5)	–	–	2,500	2.8(1.3)	8.9”(226)	0.8”(20)	1/4” 	20 (565)
41PC17TSQ4	10–39.8(1.1–4.5)	15–53.1(1.7–6.0)	–	1,700	3.1(1.4)	9.4”(239)	0.8”(20)	1/4” 	20 (565)
41PC10TSQ4	10–39.8(1.1–4.5)	15–79.7(1.7–9.0)	–	1,000	3.1(1.4)	9.4”(239)	0.8”(20)	1/4” 	20 (565)
41PC8TSQ4	10–39.8(1.1–4.5)	15–79.7(1.7–9.0)	45.1–100(5.1–11.3)	800	3.1(1.4)	9.4”(239)	0.8”(20)	1/4” 	20 (565)

Series			
41	78 dBa	1/4” NPT	5/16” (8 mm)

5 & 7 Series



Durability and performance are the hallmarks of these proven winners.



Features

- Torque range: 13.3 – 110 in-lbs (1.5 – 12.5 Nm)
- Speeds: 900 – 2,000 rpm
- One-handed reverse lever
- Recommended for applications that require a torque limiting clutch

Service and Accessories

Manuals:

-  16574576 5 Series
-  80167273

-  16574584 7 Series
-  80167299
-  16575276









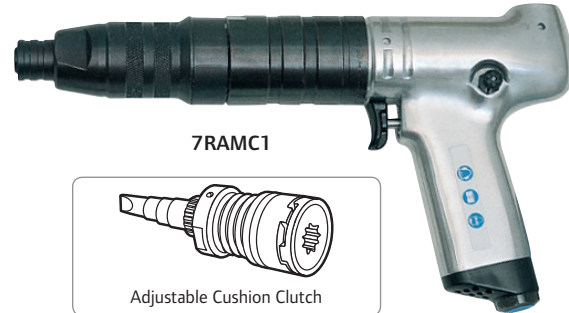





Accessories:



- Torque arm: QTA010
- Horizontal hanger: 7RA-A366
- Dead handle: 728N-A48 (5 Series only), requires (2) 5A-49
- Dead handle: R1A-A48 (7 Series only), requires (2) 7A-49
- Spring balancer
- Spindle accessories

Kits:

- Tune-up kit (5 Series): 5RA/5RL-TK1



Model	 in-lbs (Nm)	 in-lbs (Nm)	 in-lbs (Nm)	 1 min. rpm	 lbs (kg)	 in (mm)	 in (mm)	 in	 cfm (L/Min)
DC 5 SERIES TRIGGER START									
5RALC1	13.3–35.4(1.5–4.0)	–	–	2,000	2.6(1.2)	8.8" (223)	0.8" (21)	1/4" 	17 (480)
5RALC3	13.3–35.4(1.5–4.0)	–	–	2,000	2.6(1.2)	9.0" (229)	0.8" (21)	1/4" 	17 (480)
5RANC1	13.3–54.9(1.5–6.2)	54.9–70.8(6.2–8.0)	–	900	2.9(1.3)	9.5" (241)	0.8" (21)	1/4" 	17 (480)
DC 7 SERIES TRIGGER START									
7RALC1	15–55.4(1.7–6.3)	15–75.2(1.7–8.5)	–	1,800	3.1(1.4)	10.0" (254)	0.9" (23)	1/4" 	27 (760)
7RAMC1	20.4–85.9(2.3–9.7)	25.7–110.6(2.9–12.5)	–	1,000	3.3(1.5)	10.6" (268)	0.9" (23)	1/4" 	27 (760)

Series			
5	75 dBa	1/4" NPT	1/4" (6 mm)
7	79 dBa	1/4" NPT	5/16" (8 mm)

Pistol Grip Air Screwdrivers

Adjustable Cushion Clutch

QRT Series

Unique Quick Reverse Touch Control (QRT) trigger makes this the ideal tool when single-hand control of speed and rotation is required.

Features

- Torque range: 8.0 – 70.0 in-lbs (0.9 – 7.9 Nm)
- Speeds: 600 – 2,100 rpm
- Simple two-finger forward / reverse control
- Ideal for applications that require frequent reversing or realignment
- Operates as trigger + push-to-start tool in forward rotation
- Reverse trigger provides instant full-power reverse
- Recommended for applications that require a torque limiting clutch

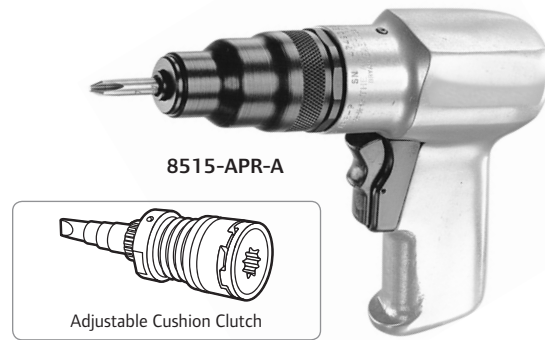

Service and Accessories

Manuals:

49999032

Accessories:

Torque arm: QTA010
Spring balancer: BLD2
Spindle accessories

Kits:

Service kit: 42114

Model	in-lbs (Nm)	rpm	lbs (kg)	in (mm)	in (mm)	in	cfm (L/Min)
DC TRIGGER + PUSH-TO-START							
8521-APR-A	8 – 40 (0.9 – 4.5)	2,100	2.5 (1.1)	7.5" (190)	0.9" (23)	1/4"	27 (762)
8515-APR-A	8 – 45 (0.9 – 5.1)	1,500	2.5 (1.1)	7.5" (190)	0.9" (23)	1/4"	27 (762)
8509-APR-A	8 – 50 (0.9 – 5.7)	900	3.1 (1.4)	8.9" (226)	0.9" (23)	1/4"	26 (732)
8506-APR-A	8 – 70 (0.9 – 7.9)	600	3.1 (1.4)	8.9" (226)	0.9" (23)	1/4"	24 (678)

Series			
QRT	82 dBa	1/4" NPT	5/16" (8 mm)

Pistol Grip Air Screwdrivers

Positive Jaw

QRT Series

Unique Quick Reverse Touch Control (QRT) trigger makes this the ideal tool when single-hand control of speed and rotation is required.

Features

- Torque range: 40 – 110 in-lbs (1.1 – 12.5 Nm)
- Speeds: 600 – 2,100 rpm
- Simple two-finger reverse control
- Ideal for applications that require frequent reversing or realignment
- Operates as trigger + push-to-start tool in forward rotation
- Recommended for applications that require more driving torque than final seating torque

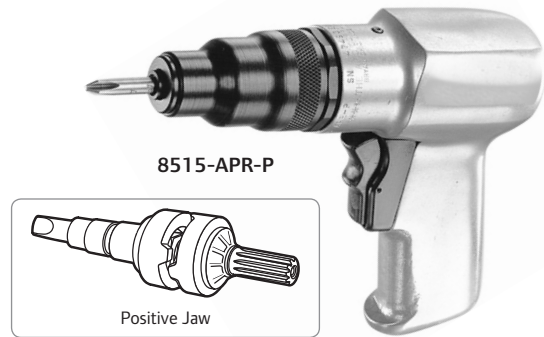

Service and Accessories

Manuals:

- 49999183 000 Series
- 49999032 0 Series

Accessories (000 Series and 0 Series):

- Torque arm: QTA010
- Spring balancer: BLD2
- Spindle accessories

Kits:

- Service kit (0 Series): 42341

Model	in-lbs (Nm)	rpm	lbs (kg)	in (mm)	in (mm)	in	cfm (L/Min)
000 QRT SERIES TRIGGER START							
8683-BPR-P	50 (5.7)	750	2.0 (0.9)	7.1" (179)	0.8" (20)	1/4"	17 (480)
0 QRT SERIES TRIGGER START							
8521-APR-P	45 (5.1)	2,100	2.2 (1.0)	6.8" (173)	0.9" (23)	1/4"	27 (762)
8515-APR-P	50 (5.7)	1,500	2.9 (1.3)	8.2" (208)	0.9" (23)	1/4"	27 (762)
8509-APR-P	80 (9.1)	900	2.9 (1.3)	8.2" (208)	0.9" (23)	1/4"	26 (732)
8506-APR-P	110 (12.5)	600	2.9 (1.3)	8.2" (208)	0.9" (23)	1/4"	24 (678)

Series	Headset	Spindle	Spindle
000	82 dBa	1/4" NPT	5/16" (8 mm)
0	82 dBa	1/4" NPT	5/16" (8 mm)

41 Series

Time-tested design known for its durability and performance.

Features

- Torque range: 45 – 120 in-lbs (5.1 – 13.6 Nm)
- Speeds: 800 – 2,500 rpm
- Skinsulate housing provides comfortable grip surface
- One-handed reverse lever
- Torque adjusted by limiting air pressure
- Recommended for applications that require more driving torque than final seating torque

Service and Accessories

Manuals:



P7098

Accessories:

Horizontal hanger: 48934
 Dead handle: 48931
 Torque arm: QTA010
 Spring balancer
 Spindle accessories

Kits:

Mechanism kit: 48804-1

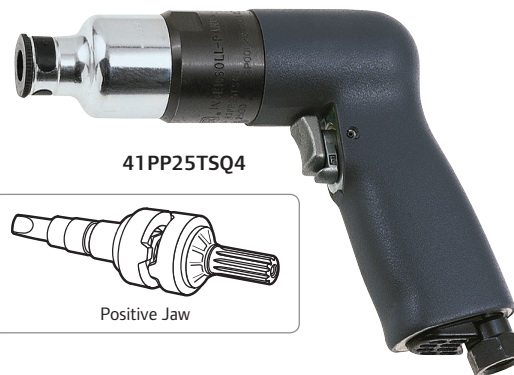

Model	in-lbs (Nm)	1 min. rpm	lbs (kg)	in (mm)	in (mm)	in	cfm (L/Min)
DC TRIGGER START							
41PP25TSQ4	45.1 (5.1)	2,500	2.2 (1.0)	7.2" (183)	0.8" (20)	1/4"	20 (565)
41PP17TSQ4	64.6 (7.3)	1,700	2.4 (1.1)	7.6" (193)	0.8" (20)	1/4"	20 (565)
41PP10TSQ4	90.3 (10.2)	1,000	2.4 (1.1)	7.6" (193)	0.8" (20)	1/4"	20 (565)
41PP8TSQ4	120.4 (13.6)	800	2.4 (1.1)	7.6" (193)	0.8" (20)	1/4"	20 (565)

Series			
41	78 dBa	1/4" NPT	5/16" (8 mm)

Pistol Grip Air Screwdrivers

Positive Jaw

5 & 7 Series

Durability and performance are the hallmarks of these proven winners.

Features

- Torque range: 35.4 – 166.4 in-lbs (4.0 – 18.8 Nm)
- Speeds: 700 – 2,000 rpm
- One-handed reverse lever
- Torque adjusted by limiting air pressure
- Recommended for applications that require more driving torque than final seating torque

Service and Accessories

Manuals:

- 16574576 5 Series
- 80167273
- 16574584 7 Series
- 16575276

Accessories:

- Torque arm: QTA010
- Dead handle: 728N-A48 (5 Series only), requires (2) 5A-49
- Dead handle: R1A-A48 (7 Series only), requires (2) 7A-49
- Spring balancer
- Spindle accessories

Kits:

- Tune-up kit (5 Series): 5RA/5RL-TK1

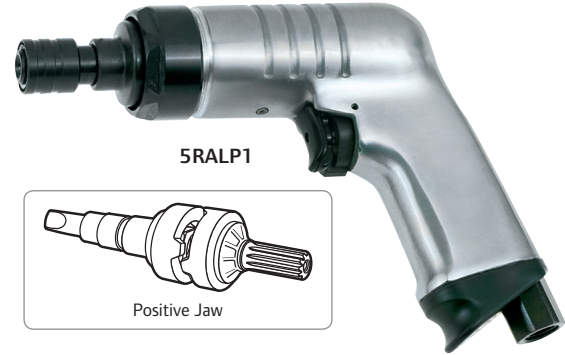

Model	in-lbs (Nm)	1 min. rpm	lbs (kg)	in (mm)	in (mm)	in	cfm (L/Min)
DC 5 SERIES TRIGGER START							
5RALP1	35.4 (4.0)	2,000	1.9 (0.9)	7.2" (184)	0.8" (21)	1/4"	17 (480)
5RANP1	70.8 (8.0)	900	2.2 (1.0)	8.0" (203)	0.8" (21)	1/4"	17 (480)
DC 7 SERIES TRIGGER START							
7RAMP1	115.9 (13.1)	1,000	3.1 (1.4)	9.3" (237)	0.9" (22)	1/4"	27 (760)
7RANP1	166.4 (18.8)	700	3.1 (1.4)	9.3" (237)	0.9" (22)	1/4"	27 (760)

Series			
5	75 dBa	1/4" NPT	1/4" (6 mm)
7	79 dBa	1/4" NPT	5/16" (8 mm)

Pistol Grip Air Screwdrivers

Stall

Q2 Series

Compact design handles tight clearance applications with ease.

Features

- Torque range: 25.7 – 86.7 in-lbs (2.9 – 9.8 Nm)
- Speeds: 500 – 2,000 rpm
- Compact, lightweight, well-balanced design
- Contoured soft grip handle
- Two-finger trigger distributes grip force and reduces stress
- Interchangeable handles offer custom fit for various hand sizes
- Top or bottom air inlets allow for optimal mounting
- Recommended for soft-draw applications in wood or other materials not requiring critical torque control



QP1S10D1TD

Stall

Service and Accessories

Manuals:















- 16574527
- 80165939

Accessories:

- Torque arm: QTA010
- Spring balancer
- Spindle accessories
- Horizontal hanger: TRP-A365

Kits:

- Inlet / throttle / motor tune-up kit: Q2-PFAST-TK1

Model	 in-lbs (Nm)	 rpm	 lbs (kg)	 in (mm)	 in (mm)	 in	 cfm (L/Min)
DC TRIGGER START							
QP1S20D1D	25.7 (2.9)	2000	1.5 (0.7)	6.4" (162)	0.6" (15)	1/4" 	16 (450)
QP1S20D1TD*	25.7 (2.9)	2000	1.5 (0.7)	6.4" (162)	0.6" (15)	1/4" 	16 (450)
QP1S15D1D	30.1 (3.4)	1500	1.5 (0.7)	6.4" (162)	0.6" (15)	1/4" 	16 (450)
QP1S15D1TD*	30.1 (3.4)	1500	1.5 (0.7)	6.4" (162)	0.6" (15)	1/4" 	16 (450)
QP1S10D1D	46 (5.2)	1000	1.5 (0.7)	6.4" (162)	0.6" (15)	1/4" 	16 (450)
QP1S10D1TD*	46 (5.2)	1000	1.5 (0.7)	6.4" (162)	0.6" (15)	1/4" 	16 (450)
QP1S05D1D	86.7 (9.8)	500	1.5 (0.7)	6.4" (162)	0.6" (15)	1/4" 	16 (450)
QP1S05D1TD*	86.7 (9.8)	500	1.5 (0.7)	6.4" (162)	0.6" (15)	1/4" 	16 (450)

*Top air inlet.

Series			
Q2	78 dBa	1/4" NPT	1/4" (6 mm)

5 & 7 Series





Durability and performance are the hallmarks of these proven winners.

Features

- Torque range: 35.4 – 70.8 in-lbs (4.0 – 8.0 Nm)
- Speeds: 900 – 2,000 rpm
- One-handed reverse lever
- Torque adjusted by limiting air pressure
- Recommended for soft-draw applications in wood or other materials not requiring critical torque control

Service and Accessories

Manuals:

-  16574576 5 Series
-  80167273
-  16574584 7 Series
-  80167299
-  16575276









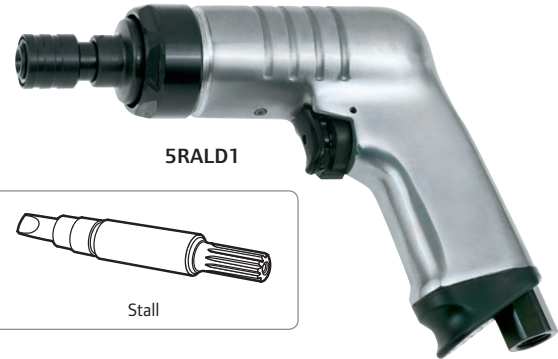

Accessories (5 Series):



- Horizontal hanger: 7RA-A366
- Dead handle: 728N-A48, requires (2) 5A-49
- Horizontal hanger: R1A-A48 (7 Series only), requires (2) 7A-49
- Torque arm: QTA010

Kits:

- Tune-up kit (5 Series): 5RA/5RL-TK1



Model	 in-lbs (Nm)	 rpm	 lbs (kg)	 in (mm)	 in (mm)	 in	 cfm (L/Min)
5 SERIES TRIGGER START							
5RALD1	35.4 (4.0)	2,000	1.9 (0.9)	7.2" (184)	0.8" (21)	1/4" 	17 (480)
5RAND1	70.8 (8.0)	900	2.1 (1.0)	8.0" (203)	0.8" (21)	1/4" 	17 (480)
7 SERIES TRIGGER START							
7RALD1	70.8 (8.0)	1,800	2.8 (1.3)	8.6" (219)	0.9" (23)	1/4" 	27 (765)

Series			
5	75 dBa	1/4" NPT	1/4" (6 mm)
7	79 dBa	1/4" NPT	5/16" (8 mm)

Pistol Grip Air Screwdrivers

Stall

41 Series

Time-tested design known for its durability and performance.

Features

- Torque range: 45 – 120 in-lbs (5.1 – 13.6 Nm)
- Speeds: 800 – 2,500 rpm
- Skinsulate housing provides comfortable grip surface
- One-handed reverse lever
- Torque adjusted by limiting air pressure
- Recommended for soft-draw applications in wood or other materials not requiring critical torque control

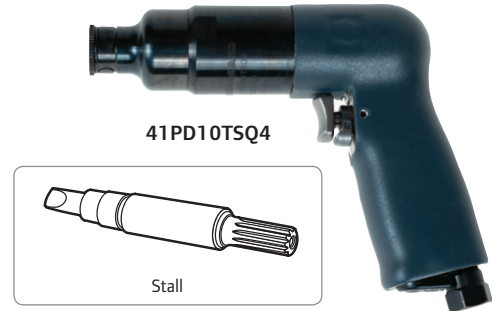

Service and Accessories

Manuals:

P7098

Accessories:

Horizontal hanger: 48934
 Dead handle: 48931
 Torque arm: QTA010
 Spring balancer
 Spindle accessories

Kits:

Mechanism kit: 48804-1

Model	in-lbs (Nm)	rpm	lbs (kg)	in (mm)	in (mm)	in	cfm (L/Min)
DC TRIGGER START							
41PD25TSQ4	45.1 (5.1)	2,500	2.1 (1.0)	6.9" (176)	0.8" (20)	1/4"	20 (565)
41PD17TSQ4	64.6 (7.3)	1,700	2.2 (1.0)	7.4" (188)	0.8" (20)	1/4"	20 (565)
41PD10TSQ4	90.3 (10.2)	1,000	2.2 (1.0)	7.4" (188)	0.8" (20)	1/4"	20 (565)
41PD8TSQ4	120.4 (13.6)	800	2.2 (1.0)	7.4" (188)	0.8" (20)	1/4"	20 (565)

Series			
41	78 dBa	1/4" NPT	5/16" (8 mm)

QRT Series

Unique Quick Reverse Touch Control (QRT) trigger makes this the ideal tool when single hand control of speed and rotation is required.

Features

- Torque Range: 15 – 110 in-lbs (1.7 – 12.5 Nm)
- Speeds: 600 – 2,300 rpm
- Simple two-finger reverse control
- Ideal for applications that require frequent reversing or realignment
- Recommended for soft-draw applications in wood or other materials not requiring critical torque control



Service and Accessories

Manuals:

	49999183	000 Series
	49999032	0 Series

Accessories (000 Series and 0 Series):

Torque arm: QTA010
Spring balancer: BLD2
Spindle accessories

Kits:

Service kit (0 Series): 42122-2

Model	in-lbs (Nm)	1 min. rpm	lbs (kg)	in (mm)	in (mm)	in	cfm (L/Min)
DC 000 SERIES TRIGGER START							
8684-BPR-D	15 (1.7)	2,300	1.3 (0.6)	4.8" (123)	0.8" (20)	1/4"	23 (648)
8683-BPR-D	50 (5.7)	750	1.6 (0.7)	6.0" (152)	0.8" (20)	1/4"	17 (480)
DC 0 SERIES TRIGGER START							
8521-BPR-D	45 (5.1)	2,100	2.2 (1.0)	6.8" (173)	0.9" (23)	1/4"	27 (762)
8515-BPR-D	50 (5.7)	1,500	2.8 (1.3)	8.2" (208)	0.9" (23)	1/4"	27 (762)
8509-BPR-D	80 (9.1)	900	2.8 (1.3)	8.2" (208)	0.9" (23)	1/4"	26 (732)
8506-BPR-D	110 (12.5)	600	2.8 (1.3)	8.2" (208)	0.9" (23)	1/4"	24 (678)

Series			
000 QRT	82 dBa	1/4" NPT	5/16" (6 mm)
0 QRT	82 dBa	1/4" NPT	5/16" (8 mm)

Inline Air Screwdrivers

Adjustable Shut-Off Clutch

Q2 Series

Sets the standard for assembly tool ergonomics.

Features

- Torque range: 2.7 – 47.8 in-lbs (0.3 - 5.4 Nm)
- Speeds: 250 – 2,000 rpm
- Compact, lightweight, well-balanced design
- Egg-shaped housing employs a natural fit
- Soft-grip surface over molded on a composite core provides a comfortable texture and temperature
- Recommended for joints where precise torque control is required



QS1P20S1D

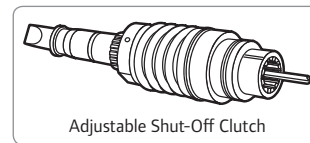

Adjustable Shut-Off Clutch

Service and Accessories

Manuals:

- 16574501, 16574493
- 80165921
- 16575185, 16575193

Accessories:

- Spring balancer
- Workstation
- Spindle accessories
- Piped away exhaust kit: LG1-K284

Kits:









- ASO tune-up kit: Q2-ASO-TK1
- Inlet / throttle / motor tune-up kit: Q2-TK1

Model	in-lbs (Nm)	in-lbs (Nm)	in-lbs (Nm)	rpm	lbs (kg)	in (mm)	in (mm)	in	cfm (L/Min)
DC LEVER START									
QS1L20S1D	2.7 – 9.7 (0.3 – 1.1)	8.0 – 22.1 (0.9 – 2.5)	–	2,000	1.5 (0.7)	9.5" (241)	0.9" (22)	1/4"	16 (450)
QS1L15S1D	2.7 – 9.7 (0.3 – 1.1)	8.0 – 27.4 (0.9 – 3.1)	–	1,500	1.5 (0.7)	9.5" (241)	0.9" (22)	1/4"	16 (450)
QS1L10S1D	2.7 – 9.7 (0.3 – 1.1)	8.0 – 22.1 (0.9 – 2.5)	13.3 – 39.8 (1.5 – 4.5)	1,000	1.5 (0.7)	9.5" (241)	0.9" (22)	1/4"	16 (450)
QS1L05S1D	2.7 – 9.7 (0.3 – 1.1)	8.0 – 28.3 (0.9 – 3.2)	13.3 – 47.8 (1.5 – 5.4)	500	1.5 (0.7)	9.5" (241)	0.9" (22)	1/4"	16 (450)
QS1L02S1D	2.7 – 9.7 (0.3 – 1.1)	8.0 – 28.3 (0.9 – 3.2)	13.3 – 47.8 (1.5 – 5.4)	250	1.5 (0.7)	9.5" (241)	0.9" (22)	1/4"	16 (450)
DC PUSH-TO-START									
QS1P20S1D	2.7 – 9.7 (0.3 – 1.1)	8.0 – 22.1 (0.9 – 2.5)	–	2,000	1.4 (0.6)	8.8" (223)	0.9" (22)	1/4"	16 (450)
QS1P15S1D	2.7 – 9.7 (0.3 – 1.1)	8.0 – 27.4 (0.9 – 3.1)	–	1,500	1.4 (0.6)	8.8" (223)	0.9" (22)	1/4"	16 (450)
QS1P10S1D	2.7 – 9.7 (0.3 – 1.1)	8.0 – 22.1 (0.9 – 2.5)	13.3 – 39.8 (1.5 – 4.5)	1,000	1.4 (0.6)	8.8" (223)	0.9" (22)	1/4"	16 (450)
QS1P05S1D	2.7 – 9.7 (0.3 – 1.1)	8.0 – 28.3 (0.9 – 3.2)	13.3 – 47.8 (1.5 – 5.4)	500	1.4 (0.6)	8.8" (223)	0.9" (22)	1/4"	16 (450)
QS1P02S1D	2.7 – 9.7 (0.3 – 1.1)	8.0 – 28.3 (0.9 – 3.2)	13.3 – 47.8 (1.5 – 5.4)	250	1.4 (0.6)	8.8" (223)	0.9" (22)	1/4"	16 (450)
QS1P15S3D	2.7 – 9.7 (0.3 – 1.1)	8.0 – 27.4 (0.9 – 3.1)	–	1,500	1.4 (0.6)	8.8" (223)	0.9" (22)	1/4"	16 (450)
QS1P10S3D	2.7 – 9.7 (0.3 – 1.1)	8.0 – 22.1 (0.9 – 2.5)	13.3 – 39.8 (1.5 – 4.5)	1,000	1.4 (0.6)	8.8" (223)	0.9" (22)	1/4"	16 (450)
QS1P05S3D	2.7 – 9.7 (0.3 – 1.1)	8.0 – 28.3 (0.9 – 3.2)	13.3 – 47.8 (1.5 – 5.4)	500	1.4 (0.6)	8.8" (223)	0.9" (22)	1/4"	16 (450)

Series			
Q2	75 dBa	1/4" NPT	1/4" (6 mm)

(continued next page)

Q2 Series *(continued)*

Model	 in-lbs (Nm)	 in-lbs (Nm)	 in-lbs (Nm)	 rpm	 lbs (kg)	 in (mm)	 in (mm)	 in	 cfm (L/Min)
DC LEVER + PUSH-TO-START									
QS1T20S1D	2.7 – 9.7 (0.3 – 1.1)	8.0 – 22.1 (0.9 – 2.5)	–	2,000	1.5 (0.7)	9.5" (241)	0.9" (22)	1/4"	16 (450)
QS1T15S1D	2.7 – 9.7 (0.3 – 1.1)	8.0 – 27.4 (0.9 – 3.1)	–	1,500	1.5 (0.7)	9.5" (241)	0.9" (22)	1/4"	16 (450)
QS1T10S1D	2.7 – 9.7 (0.3 – 1.1)	8.0 – 22.1 (0.9 – 2.5)	13.3 – 39.8 (1.5 – 4.5)	1,000	1.5 (0.7)	9.5" (241)	0.9" (22)	1/4"	16 (450)
QS1T05S1D	2.7 – 9.7 (0.3 – 1.1)	8.0 – 28.3 (0.9 – 3.2)	13.3 – 47.8 (1.5 – 5.4)	500	1.5 (0.7)	9.5" (241)	0.9" (22)	1/4"	16 (450)
QS1T02S1D	2.7 – 9.7 (0.3 – 1.1)	8.0 – 28.3 (0.9 – 3.2)	13.3 – 47.8 (1.5 – 5.4)	250	1.5 (0.7)	9.5" (241)	0.9" (22)	1/4"	16 (450)

Series			
Q2	75 dBa	1/4" NPT	1/4" (6 mm)

41 Series

Time-tested design known for its durability and performance.

Features

- Torque range: 15 – 100 in-lbs (1.7 – 11.3 Nm)
- Speeds: 800 – 2500 rpm
- Skinsulate housing provides a comfortable grip surface, requiring less force and pressure during operation
- Simple push-button reverse
- Recommended for joints where precise torque control is required



41SA10PSQ4

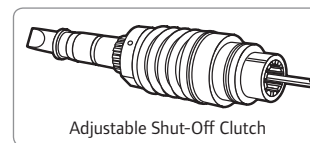

Adjustable Shut-Off Clutch

Service and Accessories

Manuals:

80167356

16575284

Accessories:

Bail: 46328

Spring balancer: BLD2

Torque reaction arm: QTA010

Dead handle: 48931

Spindle accessories

Kits:

Mechanism tune-up kit: 48804-1

Model	in-lbs (Nm)	in-lbs (Nm)	in-lbs (Nm)	rpm	lbs (kg)	in (mm)	in (mm)	in	cfm (L/Min)
DC PUSH-TO-START									
41SA17PSQ4	15 – 39.8 (1.7 – 4.5)	24.8 – 60.2 (2.8 – 6.8)	–	1,700	2.7 (1.2)	10.9" (277)	0.8" (20)	1/4"	30 (850)
41SA10PSQ4	15 – 39.8 (1.7 – 4.5)	24.8 – 60.2 (2.8 – 6.8)	35.4 – 79.7 (4.0 – 9.0)	1,000	2.7 (1.2)	10.9" (277)	0.8" (20)	1/4"	30 (850)
41SA8PSQ4	15 – 39.8 (1.7 – 4.5)	24.8 – 60.2 (2.8 – 6.8)	35.4 – 100 (4.0 – 11.3)	800	2.7 (1.2)	10.9" (277)	0.8" (20)	1/4"	30 (850)
DC LEVER + PUSH-TO-START									
41SA25LPQ4	15 – 40 (1.7 – 4.5)	–	–	2,500	2.5 (1.1)	10.4" (264)	0.8" (20)	1/4"	30 (850)
41SA17LPQ4	15 – 39.9 (1.7 – 4.5)	24.8 – 60.2 (2.8 – 6.8)	–	1,700	2.7 (1.2)	10.9" (277)	0.8" (20)	1/4"	30 (850)
41SA10LPQ4	15 – 39.8 (1.7 – 4.5)	24.8 – 60.2 (2.8 – 6.8)	35.4 – 79.7 (4.0 – 9.0)	1,000	2.7 (1.2)	10.9" (277)	0.8" (20)	1/4"	28 (790)
41SA8LPQ4	15 – 39.8 (1.7 – 4.5)	24.8 – 60.2 (2.8 – 6.8)	35.4 – 100 (4.0 – 11.3)	800	2.7 (1.2)	10.9" (277)	0.8" (20)	1/4"	28 (790)

Series			
41	78 dBa	1/4" NPT	5/16" (8 mm)

Q2 Series

Sets the standard for assembly tool ergonomics.

Features

- Torque range: 3.0 – 47.8 in-lbs (0.3 – 5.4 Nm)
- Speeds: 250 – 2,800 rpm
- Compact, lightweight, well-balanced design
- Egg-shaped housing employs a natural fit
- Soft-grip surface over molded on a composite core provides a comfortable texture and temperature
- Recommended for joints that require a torque limiting clutch



QS1P10C1D

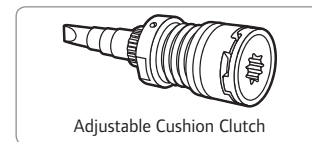

Adjustable Cushion Clutch

Service and Accessories

Manuals:

16574493, 16574501

80165921

16575185, 16575193

Accessories:

Spring balancer
Piped away exhaust kit: LG1-K284
Workstation
Spindle accessories

Kits:

QS inlet / throttle / motor tune-up kit: Q2-TK1
Cushion clutch kit: Q2-CC-TK1

Model	in-lbs (Nm)	in-lbs (Nm)	in-lbs (Nm)	rpm	lbs (kg)	in (mm)	in (mm)	in	cfm (L/Min)
DC LEVER START									
QS1L28C1D	3.0 – 9.7 (0.3 – 1.1)	–	–	2,800	1.5 (0.7)	9.5" (241)	0.9" (22)	1/4"	16 (450)
QS1L20C1D	3.0 – 9.7 (0.3 – 1.1)	8.0 – 22.1 (0.9 – 2.5)	–	2,000	1.5 (0.7)	9.5" (241)	0.9" (22)	1/4"	16 (450)
QS1L15C1D	3.0 – 9.7 (0.3 – 1.1)	8.0 – 22.1 (0.9 – 2.5)	–	1,500	1.5 (0.7)	9.5" (241)	0.9" (22)	1/4"	16 (450)
QS1L10C1D	3.0 – 9.7 (0.3 – 1.1)	8.0 – 22.1 (0.9 – 2.5)	13.3 – 40 (1.5 – 4.5)	1,000	1.5 (0.7)	9.5" (241)	0.9" (22)	1/4"	16 (450)
QS1L10C3D	3.0 – 9.7 (0.3 – 1.1)	8.0 – 22.1 (0.9 – 2.5)	13.3 – 40 (1.5 – 4.5)	1,000	1.5 (0.7)	9.5" (241)	0.9" (22)	1/4"	16 (450)
QS1L05C1D	3.0 – 9.7 (0.3 – 1.1)	8.0 – 28.3 (0.9 – 3.2)	13.3 – 47.8 (1.5 – 5.4)	500	1.5 (0.7)	9.5" (241)	0.9" (22)	1/4"	16 (450)
DC PUSH-TO-START									
QS1P28C1D	3.0 – 9.7 (0.3 – 1.1)	–	–	2,800	1.4 (0.6)	8.8" (223)	0.9" (22)	1/4"	16 (450)
QS1P20C1D	3.0 – 9.7 (0.3 – 1.1)	8.0 – 22.1 (0.9 – 2.5)	–	2,000	1.4 (0.6)	8.8" (223)	0.9" (22)	1/4"	16 (450)
QS1P15C1D	3.0 – 9.7 (0.3 – 1.1)	8.0 – 22.1 (0.9 – 2.5)	–	1,500	1.4 (0.6)	8.8" (223)	0.9" (22)	1/4"	16 (450)
QS1P10C1D	3.0 – 9.7 (0.3 – 1.1)	8.0 – 22.1 (0.9 – 2.5)	13.3 – 40.0 (1.5 – 4.5)	1,000	1.4 (0.6)	8.8" (223)	0.9" (22)	1/4"	16 (450)
QS1P05C1D	3.0 – 9.7 (0.3 – 1.1)	8.0 – 28.3 (0.9 – 3.2)	13.3 – 47.8 (1.5 – 5.4)	500	1.4 (0.6)	8.8" (223)	0.9" (22)	1/4"	16 (450)

Series			
Q2	75 dBa	1/4" NPT	1/4" (6 mm)

41 Series

Time-tested design known for its durability and performance.

Features

- Torque range: 10 – 100 in-lbs (1.1 – 11.3 Nm)
- Speeds: 800 – 2,500 rpm
- Skinsulate housing provides a comfortable grip surface, requiring less force and pressure during operation
- Simple push-button reverse
- Recommended for assembling that requires a torque limiting clutch

Service and Accessories

Manuals:

 80167356

 16575284

Accessories:

Torque arm
Spring balancer
Spindle accessories
Dead handle: 48931
Bail: 46328

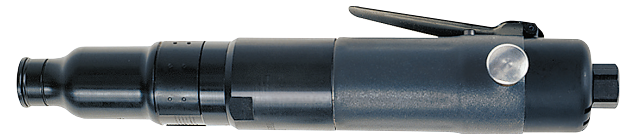



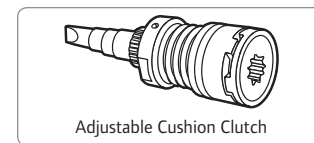













41SC10LTQ4



Adjustable Cushion Clutch

Kits:

Mechanism tune-up kit: 48804-1

Model	 in-lbs (Nm)	 in-lbs (Nm)	 in-lbs (Nm)	 rpm	 lbs (kg)	 in (mm)	 in (mm)	 in	 cfm (L/Min)
DC LEVER START									
41SC25LTQ4	9.7 – 39.8 (1.1 – 4.5)	–	–	2,500	2.9 (1.3)	10.4" (264)	0.8" (20)	1/4" 	20 (565)
41SC17LTQ4	9.7 – 39.8 (1.1 – 4.5)	15 – 60.2 (1.7 – 6.8)	–	1,700	3.1 (1.4)	10.9" (277)	0.8" (20)	1/4" 	20 (565)
41SC10LTQ4	9.7 – 39.8 (1.1 – 4.5)	15 – 79.7 (1.7 – 9.0)	–	1,000	3.1 (1.4)	10.9" (277)	0.8" (20)	1/4" 	20 (565)
41SC8LTQ4	9.7 – 39.8 (1.1 – 4.5)	15 – 79.7 (1.7 – 9.0)	45 – 100 (5.1 – 11.3)	800	3.1 (1.4)	10.9" (277)	0.8" (20)	1/4" 	20 (565)
DC PUSH-TO-START									
41SC25PSQ4	9.7 – 39.8 (1.1 – 4.5)	–	–	2,500	2.8 (1.3)	10.4" (264)	0.8" (20)	1/4" 	20 (565)
41SC17PSQ4	9.7 – 39.8 (1.1 – 4.5)	15 – 60.2 (1.7 – 6.8)	–	1,700	3.1 (1.4)	10.9" (277)	0.8" (20)	1/4" 	20 (565)
41SC10PSQ4	9.7 – 39.8 (1.1 – 4.5)	15 – 79.7 (1.7 – 9.0)	–	1,000	3.1 (1.4)	10.9" (277)	0.8" (20)	1/4" 	20 (565)
41SC8PSQ4	9.7 – 39.8 (1.1 – 4.5)	15 – 79.7 (1.7 – 9.0)	45 – 100 (5.1 – 11.3)	800	3.1 (1.4)	10.9" (277)	0.8" (20)	1/4" 	20 (565)

Series			
41	78 dBa	1/4" NPT	5/16" (8 mm)

Inline Air Screwdrivers

Adjustable Cushion Clutch

5 & 7 Series







Durability and performance are the hallmarks of these proven winners.

Features

- Torque range: 13 – 110 in-lbs (1.5 – 12.5 Nm)
- Speeds: 1,000 – 2,100 rpm
- Simple push-button reverse
- External torque adjustments with no tool disassembly required
- Recommended for assembly that requires a torque limiting clutch

Service and Accessories

Manuals:

-  16574576 5 Series
-  80167273
-  16575276
-  16574584 7 Series
-  80167299
-  16575276

Accessories:

- Dead handle: 728N-A48 (5 Series only) requires (2) 5A-49, R1A-A48 (7 Series only) requires (2) 7A-49
- Suspension bail: 5RL-365 (5 Series only), 7L-365 (7 Series only)
- Piped away exhaust kit: 5L-K184 (5 Series only), 7L-K284 (7 Series only)
- Torque arm
- Spindle accessories
- Spring balancer

Kits:







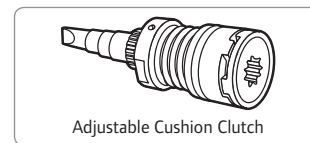







- Mechanism tune-up kit (7 Series): 6RL-S/D-A/T-TK1





7RLMC1



Adjustable Cushion Clutch

Model	 in-lbs (Nm)	 in-lbs (Nm)	 in-lbs (Nm)	 rpm	 lbs (kg)	 in (mm)	 in (mm)	 in	 cfm (L/Min)
5 SERIES LEVER START									
5RLLC1	13 – 35 (1.5 – 4.0)	–	–	2,100	2.6 (1.1)	10.0" (254)	0.8" (21)	1/4" 	16 (460)
5RLNC1	13 – 54 (1.5 – 6.3)	55 – 75 (6.3 – 8.5)	–	1,000	2.9 (1.3)	10.7" (273)	0.8" (21)	1/4" 	16 (460)
5RLNC3	13 – 54 (1.5 – 6.3)	55 – 75 (6.3 – 8.5)	–	1,000	2.9 (1.3)	11.0" (279)	0.8" (21)	1/4" 	16 (460)
7 SERIES LEVER START									
7RLLC1	15 – 55 (1.7 – 6.3)	15 – 75 (1.7 – 8.5)	–	2,100	2.9 (1.3)	11.3" (287)	0.9" (22)	1/4" 	27 (762)
7RLMC1	20 – 85 (2.3 – 9.7)	25 – 110 (2.8 – 12.5)	–	1,200	3.1 (1.4)	11.9" (302)	0.9" (22)	1/4" 	27 (762)

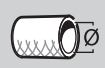
Series			
5	75 dBa	1/4" NPT	1/4" (6 mm)
7	79 dBa	1/4" NPT	5/16" (8 mm)

Inline Air Screwdrivers

Positive Jaw

41 Series

Time-tested design known for its durability and performance.

Features

- Torque range: 45 – 120 in-lbs (5.1 – 13.6 Nm)
- Speeds: 800 – 2,500 rpm
- Skinsulate housing provides a comfortable grip surface, requiring less force and pressure during operation
- Simple push-button reverse
- Recommended for assembly that requires more driving torque than final seating torque

Service and Accessories

Manuals:

- 80167356
- 16575284

Accessories:

- Torque reaction arm: QTA010
- Dead handle: 48931
- Suspension bail: 46328
- Spring balancer
- Spindle accessories



41SP10LTQ4

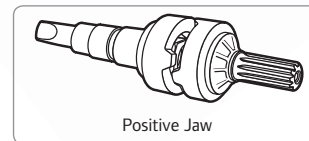

Positive Jaw

Kits:

- Mechanism tune-up kit: 48804-1

Model	in-lbs (Nm)	1 min. rpm	lbs (kg)	in (mm)	in (mm)	in	cfm (L/Min)
DC LEVER START							
41SP25LTQ4	45 (5.1)	2,500	2.2 (1.0)	8.6" (218)	0.8" (20)	1/4"	20 (565)
41SP17LTQ4	65 (7.3)	1,700	2.4 (1.1)	9.1" (231)	0.8" (20)	1/4"	20 (565)
41SP10LTQ4	90 (10.2)	1,000	2.4 (1.1)	9.1" (231)	0.8" (20)	1/4"	20 (565)
41SP8LTQ4	120 (13.6)	800	2.4 (1.1)	9.1" (231)	0.8" (20)	1/4"	20 (565)

Series			
41	78 dBa	1/4" NPT	5/16" (8 mm)

Inline Air Screwdrivers

Stall

Q2 Series

Sets the standard for assembly tool ergonomics.

Features

- Torque range: 16 – 51 in-lbs (1.8 – 5.8 Nm)
- Speeds: 1,000 – 2,800 rpm
- Compact, lightweight, well-balanced design
- Egg-shaped housing employs a natural fit
- Soft-grip surface over molded on a composite core provides a comfortable texture and temperature
- Recommended for soft draw applications in wood or other materials not requiring critical torque control



QS1L10D1D

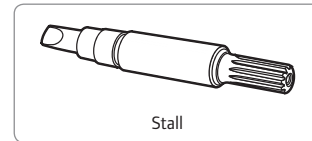

Service and Accessories

Manuals:

- 16574501
- 80165921
- 16575193

Accessories:

- Spring balancer
- Workstation
- Spindle accessories
- Piped away exhaust kit: L01-K284

Kits:

- Inlet / throttle / motor tune up kit: Q2-TK1

Model	in-lbs (Nm)	rpm	lbs (kg)	in (mm)	in (mm)	in	cfm (L/Min)
DC LEVER START							
QS1L28D1D	16 (1.8)	2,800	1.3 (0.6)	9.5" (241)	0.9" (22)	1/4"	16 (460)
QS1L20D1D	26 (2.9)	2,000	1.3 (0.6)	9.5" (241)	0.9" (22)	1/4"	16 (460)
QS1L10D1D	51 (5.8)	1,000	1.3 (0.6)	9.5" (241)	0.9" (22)	1/4"	16 (460)

Series	75 dBa	1/4" NPT	1/4" (6 mm)
Q2	75 dBa	1/4" NPT	1/4" (6 mm)

41 Series

Time-tested design known for its durability and performance.

Features

- Torque Range: 45 – 120 in-lbs (5.1 – 13.6 Nm)
- Speeds: 800 – 2,500 rpm
- Skinsulate housing provides a comfortable grip surface, requiring less force and pressure during operation
- Simple push-button reverse
- Recommended for soft pull applications not requiring critical torque control

Service and Accessories

Manuals:

 80167356

 16575284

Accessories:

Dead handle: 48931

Torque reaction arm: QTA010

Spindle accessories

Bail: 46328





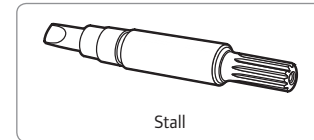







41SD10LTQ4



Kits:

Mechanism tune-up kit: 48804-1

Model	 in-lbs (Nm)	 rpm	 lbs (kg)	 in (mm)	 in (mm)	 in	 cfm (L/Min)
DC LEVER START							
41SD25LTQ4	45 (5.1)	2,500	2.1 (1.0)	8.1" (206)	0.8" (20)	1/4" 	20 (565)
41SD17LTQ4	65 (7.3)	1,700	2.3 (1.1)	8.9" (226)	0.8" (20)	1/4" 	20 (565)
41SD10LTQ4	90 (10.2)	1,000	2.3 (1.1)	8.9" (226)	0.8" (20)	1/4" 	20 (565)
41SD8LTQ4	120 (13.6)	800	2.3 (1.1)	8.9" (226)	0.8" (20)	1/4" 	20 (565)

Series			
41	75 dBa	1/4" NPT	5/16" (8 mm)

Angle Air Nutrunners

Adjustable Shut-Off

Q2 Series

Sets the standard for assembly tool ergonomics.

Features

- Torque range: 3.5 – 101.5 in-lbs (0.4 – 11.5 Nm)
- Speeds: 250 – 1,750 rpm
- Offers precise torque control in a quiet, award-winning ergonomic package
- Compact, lightweight, well-balanced design
- Contoured soft grip handle
- Low force forward reverse control
- Recommended for applications where precise torque control is required



QA1L05S4LD

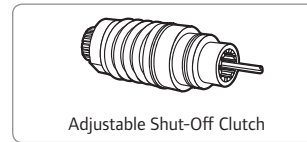

Adjustable Shut-Off Clutch

Service and Accessories

Manuals:

- 16574543
- 80167406
- 16584062

Accessories:

- Spring balancer
- Vertical hanger: 7L-365
- Piped away exhaust kit: LG1-K284























Kits:





- Service kit: 48803-1
- Clutch kit: Q2-ASO-TK1
- Inlet / throttle / motor kit: Q2-TK1

Model	in-lbs (Nm)	in-lbs (Nm)	in-lbs (Nm)	rpm	lbs (kg)	in (mm)	in (mm)	in (mm)	in
CC LEVER START									
QA1L18S4LD	3.5 – 11.5 (0.4 – 1.3)	9.3 – 26.1 (1.05 – 2.95)	–	1,750	2.1 (1.0)	11.9" (302.3)	0.52" (13.2)	1.3" (33)	1/4"
QA1L18S4SD	3.5 – 11.5 (0.4 – 1.3)	9.3 – 26.1 (1.05 – 2.95)	–	1,750	1.9 (0.9)	11.8" (300)	0.38" (9.5)	1.1" (28)	1/4"
QA1L18S6LD	3.5 – 11.5 (0.4 – 1.3)	9.3 – 26.1 (1.05 – 2.95)	–	1,750	2.1 (1.0)	11.9" (302.3)	0.52" (13.2)	1.3" (33)	3/8"
QA1L18S1LD	3.5 – 11.5 (0.4 – 1.3)	9.3 – 26.1 (1.05 – 2.95)	–	1,750	2.1 (1.0)	11.9" (302.3)	0.52" (13.2)	1.3" (33)	1/4"
QA1L18S9LD	3.5 – 11.5 (0.4 – 1.3)	9.3 – 26.1 (1.05 – 2.95)	–	1,750	2.1 (1.0)	11.9" (302.3)	0.52" (13.2)	1.3" (33)	1/4"
QA1L12S4LD	3.5 – 11.5 (0.4 – 1.3)	9.3 – 32.2 (1.01 – 3.64)	–	1,270	2.1 (1.0)	11.9" (302.3)	0.52" (13.2)	1.3" (33)	1/4"
QA1L12S4SD	3.5 – 11.5 (0.4 – 1.3)	9.3 – 32.2 (1.01 – 3.64)	–	1,270	1.9 (0.9)	11.8" (300)	0.38" (9.5)	1.1" (28)	1/4"
QA1L12S1LD	3.5 – 11.5 (0.4 – 1.3)	9.3 – 32.2 (1.01 – 3.64)	–	1,270	2.1 (1.0)	11.9" (302.3)	0.52" (13.2)	1.3" (33)	1/4"
QA1L12S9LD	3.5 – 11.5 (0.4 – 1.3)	9.3 – 32.2 (1.01 – 3.64)	–	1,270	2.1 (1.0)	11.9" (302.3)	0.52" (13.2)	1.3" (33)	1/4"
QA1L08S4LD	3.5 – 11.5 (0.4 – 1.3)	9.3 – 33.4 (1.05 – 3.77)	15.7 – 47.2 (1.77 – 5.33)	850	2.1 (1.0)	11.9" (302.3)	0.52" (13.2)	1.3" (33)	1/4"
QA1L08S6LD	3.5 – 11.5 (0.4 – 1.3)	9.3 – 33.4 (1.05 – 3.77)	15.7 – 47.2 (1.77 – 5.33)	850	2.1 (1.0)	11.9" (302.3)	0.52" (13.2)	1.3" (33)	3/8"

(continued next page)

Q2 Series *(continued)*

Model	 in-lbs (Nm)	 in-lbs (Nm)	 in-lbs (Nm)	 rpm	 lbs (kg)	 in (mm)	 in (mm)	 in (mm)	 in
DC LEVER START									
QA1L08S9LD	3.5 – 11.5 (0.4 – 1.3)	9.3 – 26.1 (1.05 – 2.95)	15.7 – 47.2 (1.77 – 5.33)	850	2.1 (1.0)	11.9" (302.3)	0.52" (13.2)	1.3" (33)	1/4" 
QA1L08S1LD	3.5 – 11.5 (0.4 – 1.3)	9.3 – 26.1 (1.05 – 2.95)	15.7 – 47.2 (1.77 – 5.33)	850	2.1 (1.0)	11.9" (302.3)	0.52" (13.2)	1.3" (33)	1/4" 
QA1L05S4SD	3.5 – 11.5 (0.4 – 1.3)	9.3 – 26.1 (1.05 – 2.95)	–	500	1.9 (0.9)	11.8" (300)	0.38" (9.5)	1.1" (28)	1/4" 
QA1L05S4LD	3.5 – 11.5 (0.4 – 1.3)	9.3 – 26.1 (1.05 – 2.95)	15.7 – 56.4 (1.77 – 6.37)	500	2.1 (0.9)	11.9" (302.3)	0.52" (13.2)	1.3" (33)	1/4" 
QA1L05S6LD	3.5 – 11.5 (0.4 – 1.3)	9.3 – 26.1 (1.05 – 2.95)	15.7 – 56.4 (1.77 – 6.37)	500	2.1 (0.9)	11.9" (302.3)	0.52" (13.2)	1.3" (33)	3/8" 
QA1L05S6XLD	11.7 – 38.2 (1.32 – 4.32)	31 – 88.3 (3.5 – 9.98)	–	500	2.3 (1.04)	13" (330)	0.52" (13.2)	1.3" (33)	3/8" 
QA1L05S9LD	3.5 – 11.5 (0.4 – 1.3)	9.3 – 32.2 (1.01 – 3.64)	15.7 – 56.4 (1.77 – 6.37)	500	2.1 (1.0)	11.9" (302.3)	0.52" (13.2)	1.3" (33)	1/4" 
QA1L05S1LD	3.5 – 11.5 (0.4 – 1.3)	9.3 – 32.2 (1.01 – 3.64)	15.7 – 56.4 (1.77 – 6.37)	500	2.1 (1.0)	11.9" (302.3)	0.52" (13.2)	1.3" (33)	1/4" 
QA1L05S1XLD	11.7 – 38.2 (1.32 – 4.32)	31 – 88.3 (3.5 – 9.98)	–	500	2.3 (1.04)	13" (330)	0.52" (13.2)	1.3" (33)	1/4" 
QA1L02S4LD	3.5 – 11.5 (0.4 – 1.3)	9.3 – 33.4 (1.05 – 3.77)	15.7 – 56.4 (1.77 – 6.37)	250	2.1 (1.0)	11.9" (302.3)	0.52" (13.2)	1.3" (33)	1/4" 
QA1L02S1LD	3.5 – 11.5 (0.4 – 1.3)	9.3 – 33.4 (1.05 – 3.77)	15.7 – 56.4 (1.77 – 6.37)	250	2.1 (1.0)	11.9" (302.3)	0.52" (13.2)	1.3" (33)	1/4" 
QA1L02S6LD	3.5 – 11.5 (0.4 – 1.3)	9.3 – 33.4 (1.05 – 3.77)	15.7 – 56.4 (1.77 – 6.37)	250	2.1 (1.0)	11.9" (302.3)	0.52" (13.2)	1.3" (33)	3/8" 
QA1L02S6XLD	11.7 – 38.2 (1.32 – 4.32)	31 – 101.5 (3.5 – 11.5)	–	250	2.3 (1.04)	13" (330)	0.52" (13.2)	1.3" (33)	3/8" 
QA1L02S1XLD	11.7 – 38.2 (1.32 – 4.32)	31 – 101.5 (3.5 – 11.5)	–	250	2.3 (1.04)	13" (330)	0.52" (13.2)	1.3" (33)	1/4" 

Series				
Q2	75 dBa	1/4" NPT	1/4" (6 mm)	16 cfm (450 L/Min)

41 Series

Time-tested design known for its durability and performance.

Features

- Torque Range: 25 – 130 in-lbs (2.8 – 14.7 Nm)
- Speeds: 600 – 950 rpm
- Auto-shut-off clutch provides accuracy with proven durability
- Multiple drive sizes available
- Recommended for applications where precise torque control is required

Service and Accessories

Manuals:

 16574600

 80167398

Accessories:

Spring balancer: BLD2
Sockets, see form # IR-0506-016





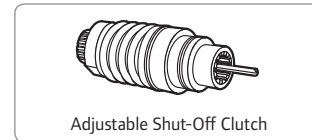





41AA9LTS6







Adjustable Shut-Off Clutch

Kits:

Service kit: 48804-1

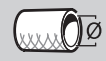
Model	 in-lbs (Nm)	 in-lbs (Nm)	 in-lbs (Nm)	 rpm	 lbs (kg)	 in (mm)	 in (mm)	 in (mm)	 in
DC LEVER START									
41AA9LTS6	25 – 58 (2.8 – 6.5)	25 – 90 (2.8 – 10.2)	-	950	3.9 (1.8)	14.2" (360)	0.6" (15)	1.5" (38.1)	3/8" □
41AA9LTH4	25 – 58 (2.8 – 6.5)	25 – 90 (2.8 – 10.2)	-	950	3.9 (1.8)	14.2" (360)	0.6" (15)	1.5" (38.1)	1/4" ⬡
41AA6LTS6	23 – 52 (2.6 – 5.9)	23 – 81 (2.6 – 9.2)	35 – 130 (4.0 – 14.7)	600	4 (1.8)	14.2" (360)	0.7" (17.8)	1.9" (48.3)	3/8" □
41AA6LTH4	23 – 52 (2.6 – 5.9)	23 – 81 (2.6 – 9.2)	35 – 130 (4.0 – 14.7)	600	4 (1.8)	14.2" (360)	0.7" (17.8)	1.9" (48.3)	1/4" ⬡

Series				
41	79 dBa	1/4" NPT	5/16" (8 mm)	31 cfm (878 L/Min)

Angle Air Nutrunners

Adjustable Shut-Off

QA4 Series

Accuracy, durability, and flexibility combine to maximize productivity.

Features

- Torque Range: 3.7 – 40.6 ft-lbs (5.0 – 55 Nm)
- Speeds: 200 – 1,025 rpm
- Adjustable shut-off clutch provides repeatability that improves joint quality
- Quick, precise shut-off limits scatter and torque reaction
- Lube-free motor
- Proven durability using world-class QE Series components
- Ergonomic grip for operator comfort
- Recommended for applications where precise torque control is required

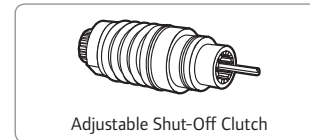

Service and Accessories

Manuals:

- 80160344
- 80160336
- 80217474

Accessories:

- Torque arms
- Swivel hanger: 129851
- Piped away exhaust kit: QA4-EXH-989
- Cycle count part kit: 131711
- Mounting flanges
- Spring balancer

Kits:

- Motor kit: QA4-1-K53
- Housing kit: QA4-1-K40
- Clutch ball kit: QA4-1-K581

Model	90 psi ft-lbs (Nm)	90 psi rpm	77 psi ft-lbs (Nm)	77 psi rpm	lbs (kg)	in (mm)	in (mm)	in (mm)	in
OC LEVER START									
QA4AALS011NP25S06	3.7 – 8.5 (5.0 – 11)	1,025	3.7 – 7.2 (5.0 – 9.7)	953	3.17 (1.44)	13.5" (342)	0.50" (13)	1.28" (33)	3/8"
QA4AALS015NP25S06	5.2 – 11.1 (7.0 – 15)	800	5.2 – 9.4 (7.0 – 12.7)	744	3.17 (1.44)	13.5" (342)	0.50" (13)	1.28" (33)	3/8"
QA4AALS020NP25S06	7.4 – 14.8 (10 – 20)	625	7.4 – 12.5 (10 – 17)	581	3.17 (1.44)	13.5" (342)	0.50" (13)	1.28" (33)	3/8"
QA4AALS020NP28S06	7.4 – 14.8 (10 – 20)	625	7.4 – 12.5 (10 – 17)	581	3.35 (1.52)	14.3" (363)	0.55" (14)	1.39" (35)	3/8"
QA4AALS030NP28S06	11.1 – 22.1 (15 – 30)	425	11.1 – 18.8 (15 – 25.5)	395	3.6 (1.6)	14.3" (363)	0.55" (14)	1.39" (35)	3/8"
QA4AALS040NP35S06	14.8 – 29.5 (20 – 40)	325	14.8 – 25.1 (20 – 34)	302	3.98 (1.81)	15.6" (395)	0.69" (18)	1.71" (44)	3/8"
QA4AALS040NP35S08	14.8 – 29.5 (20 – 40)	325	14.8 – 25.1 (20 – 34)	302	4.00 (2.04)	15.6" (418)	0.69" (18)	1.71" (44)	1/2"
QA4AALS055NP35S08	18.4 – 40.6 (25 – 55)	200	18.4 – 33.6 (25 – 45.5)	186	4.50 (2.04)	16.4" (418)	0.69" (18)	1.71" (44)	1/2"

Series				
QA4	79.3 dBa	1/4" NPT	3/8" (8 mm)	27 cfm (765 L/Min)

QA6 Series

Accuracy, durability, and flexibility combine to maximize productivity.



Features

- Torque Range: 11.1 – 66.4 ft-lbs (15 – 90 Nm)
- Speeds: 175 – 580 rpm
- Adjustable shut-off clutch provides repeatability that improves joint quality
- Quick, precise shut-off limits scatter and torque reaction
- Lube-free motor
- Proven durability using world-class QE Series components
- Ergonomic grip for operator comfort
- Recommended for applications where precise torque control is required

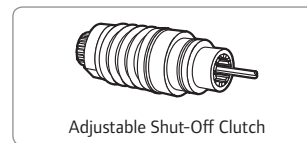

Adjustable Shut-Off Clutch

Service and Accessories

Manuals:

- 16601072
- 16601064
- 16601056

Accessories:

- Swivel hanger: QA6-A365-S
- Piped away exhaust kit: QA6-K284
- Torque arms
- Mounting flanges
- Sockets, see form # IR-0506-016

Kits:

- Motor kit: QA6-1-K53
- Clutch ball kit: QA6-1-K581
- Housing kit: QA6-1-K581

Model	90 psi ft-lbs (Nm)	90 psi rpm	77 psi ft-lbs (Nm)	77 psi rpm	lbs (kg)	in (mm)	in (mm)	in (mm)	in
DC LEVER START									
QA6AALS030NP35S06	11.1 – 22.1 (15 – 30)	580	11.1 – 19.9 (15 – 27)	550	5.05 (2.29)	16.9" (429)	0.69" (18)	1.71" (44)	3/8"
QA6AALS040NP35S06	14.8 – 29.5 (20 – 40)	430	14.8 – 25.8 (20 – 35)	405	5.05 (2.29)	16.9" (429)	0.69" (18)	1.71" (44)	3/8"
QA6AALS040NP35S08	14.8 – 29.5 (20 – 40)	430	14.8 – 25.8 (20 – 35)	405	5.07 (2.30)	16.9" (429)	0.69" (18)	1.71" (44)	1/2"
QA6AALS055NP35S08	18.4 – 40.6 (25 – 55)	320	18.4 – 36.1 (25 – 49)	300	5.07 (2.30)	16.9" (429)	0.69" (18)	1.71" (44)	1/2"
QA6AALS070NP43S08	25.8 – 51.6 (35 – 70)	225	25.8 – 45.7 (35 – 62)	215	5.07 (2.30)	16.6" (422)	0.85" (22)	1.76" (45)	1/2"
QA6AALS090NP43S08	14.8 – 29.5 (20 – 40)	185	33.2 – 59 (45 – 80)	175	5.07 (2.30)	16.6" (422)	0.85" (22)	1.76" (45)	1/2"

Series				
QA6	82.5 dBa	3/8" NPT	1/2" (13 mm)	36 cfm (1019 L/Min)

Angle Air Nutrunners

Adjustable Shut-Off

QA8 Series

Accuracy, durability, and flexibility combine to maximize productivity.

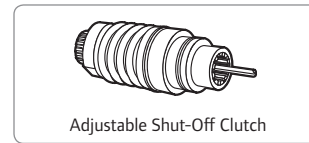

Features

- Torque Range: 14.8 – 166 ft-lbs (20 – 225 Nm)
- Speeds: 85 – 570 rpm
- Adjustable shut-off clutch provides repeatability that improves joint quality
- Quick, precise shut-off limits scatter and torque reaction
- Lube-free motor
- Proven durability using world-class QE Series components
- Ergonomic grip for operator comfort
- Recommended for applications where precise torque control is required

Service and Accessories

Manuals:

- 16601072
- 16601064
- 16601056

Accessories:

- Swivel hanger: QA6-A365-S
- Piped away exhaust kit: QA6-K284
- Torque arms
- Mounting flanges
- Sockets, see form # IR-0506-016

Kits:

- Motor kit: QA6-1-K53
- Clutch ball kit: QA6-1-K581
- Housing kit: QA8-1-K40

Model	90 psi ft-lbs (Nm)	1 min. 90 psi rpm	77 psi ft-lbs (Nm)	1 min. 77 psi rpm	lbs (kg)	in (mm)	in (mm)	in (mm)	in
DC LEVER START									
QA8AALS040NP35S06	14.8 – 29.5 (20 – 40)	570	14.8 – 25.8 (20 – 35)	540	5.38 (2.44)	17.8" (453)	0.69" (18)	1.71" (44)	3/8"
QA8AALS040NP35S08	14.8 – 29.5 (20 – 40)	570	14.8 – 25.8 (20 – 35)	540	5.40 (2.45)	17.8" (453)	0.69" (18)	1.71" (44)	1/2"
QA8AALS055NP35S08	18.4 – 40.6 (25 – 55)	425	18.4 – 36.1 (25 – 49)	400	5.40 (2.45)	17.8" (453)	0.69" (18)	1.71" (44)	1/2"
QA8AALS070NP43S08	25.8 – 51.6 (35 – 70)	320	25.8 – 45.7 (35 – 62)	305	5.40 (2.45)	17.5" (445)	0.85" (22)	1.76" (45)	1/2"
QA8AALS090NP43S08	33.2 – 66.4 (45 – 90)	255	33.2 – 59.0 (45 – 80)	240	5.40 (2.45)	17.5" (445)	0.85" (22)	1.76" (45)	1/2"
QA8AALS115NP48S08	51.6 – 84.8 (70 – 115)	200	51.6 – 75.2 (70 – 102)	190	6.15 (2.79)	17.8" (452)	0.97" (25)	1.97" (50)	1/2"
QA8AALS150NP48S08	55.3 – 110.6 (75 – 150)	145	55.3 – 98.1 (75 – 133)	140	6.88 (3.12)	19.2" (489)	0.97" (25)	1.97" (50)	1/2"
QA8AALS200NF56S12	73.8 – 147.5 (100 – 200)	110	73.8 – 131.3 (100 – 178)	105	8.86 (4.02)	20" (508)	1.19" (30)	2.09" (53)	3/4"
QA8AALS225NF56S12	92.2 – 166 (125 – 225)	90	92.2 – 163.7 (125 – 222)	85	8.86 (4.02)	20" (508)	1.19" (30)	2.09" (53)	3/4"

Series				
QA8	87 dBa	3/8" NPT	1/2" (13 mm)	41 cfm (1161 L/Min)

Angle Air Nutrunners

Adjustable Cushion Clutch

Q2 Series

Sets the standard for assembly tool ergonomics.

Features

- Torque range: 3.5 – 56.4 in-lbs (0.4 – 6.4 Nm)
- Speeds: 500 – 1,750 rpm
- Offers torque limiting control in a quiet, award-winning ergonomic package
- Compact, lightweight, well-balanced design
- Contoured soft grip handle
- Low force forward reverse control
- Recommended for applications requiring a torque limiting clutch



QA1L08C4LD

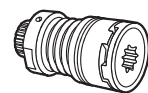

Adjustable Cushion Clutch

Service and Accessories

Manuals:

- 16574519, 16574543
- 80167406
- 16575201, 16584062

Accessories:

- Spring balancer
- Hanger: 7L-365
- Piped away exhaust kit: LG1-K284
- Sockets, see form # IR-0506-016

Kits:

- Cushion clutch kit: Q2-CC-TK1
- Inlet / throttle / motor kit: Q2-TK1

Model	in-lbs (Nm)	in-lbs (Nm)	in-lbs (Nm)	rpm	lbs (kg)	in (mm)	in (mm)	in (mm)	in
DC LEVER START									
QA1L18C4LD	3.5 – 11.5 (0.4 – 1.3)	9.3 – 26.1 (1.05 – 2.95)	–	1,750	2.0 (0.9)	11.9" (302.3)	0.52" (13.2)	1.3" (33)	1/4"
QA1L18C1LD	3.5 – 11.5 (0.4 – 1.3)	9.3 – 26.1 (1.05 – 2.95)	–	1,750	2.0 (0.9)	11.9" (302.3)	0.52" (13.2)	1.3" (33)	1/4"
QA1L12C4LD	3.5 – 11.5 (0.4 – 1.3)	9.3 – 32.2 (1.1 – 3.64)	–	1,270	2.0 (0.9)	11.9" (302.3)	0.52" (13.2)	1.3" (33)	1/4"
QA1L12C1LD	3.5 – 11.5 (0.4 – 1.3)	9.3 – 32.7 (1.1 – 3.64)	–	1,270	2.1 (1.0)	11.9" (302.3)	0.52" (13.2)	1.3" (33)	1/4"
QA1L12C9LD	3.5 – 11.5 (0.4 – 1.3)	9.3 – 32.2 (1.1 – 3.64)	–	1,270	2.1 (1.0)	11.9" (302.3)	0.52" (13.2)	1.3" (33)	1/4"
QA1L12C6LD	3.5 – 11.5 (0.4 – 1.3)	9.3 – 32.2 (1.1 – 3.64)	–	1,270	2.1 (1.0)	11.9" (302.3)	0.52" (13.2)	1.3" (33)	3/8"
QA1L08C4LD	3.5 – 11.5 (0.4 – 1.3)	9.3 – 33.4 (1.05 – 3.77)	15.7 – 47.2 (1.77 – 5.33)	850	2.0 (0.9)	11.9" (302.3)	0.52" (13.2)	1.3" (33)	1/4"
QA1L08C1LD	3.5 – 11.5 (0.4 – 1.3)	9.3 – 33.4 (1.05 – 3.77)	15.7 – 47.2 (1.77 – 5.33)	850	2.1 (1.0)	11.9" (302.3)	0.52" (13.2)	1.3" (33)	1/4"
QA1L08C9LD	3.5 – 11.5 (0.4 – 1.3)	9.3 – 33.4 (1.05 – 3.77)	15.7 – 47.2 (1.77 – 5.33)	850	2.1 (1.0)	11.9" (302.3)	0.52" (13.2)	1.3" (33)	1/4"













Series				
Q2	75 dBa	1/4" NPT	1/4" (6 mm)	16 cfm (450 L/Min)



(continued next page)

Angle Air Nutrunners

Adjustable Cushion Clutch

Q2 Series *(continued)*

									
Model	in-lbs (Nm)	in-lbs (Nm)	in-lbs (Nm)	rpm	lbs (kg)	in (mm)	in (mm)	in (mm)	in
DC LEVER START									
QA1L05C1LD	3.5 – 11.5 (0.4 – 1.3)	9.3 – 33.4 (1.05 – 3.77)	15.7 – 56.4 (1.77 – 6.37)	500	2.1 (1.0)	11.9" (302.3)	0.5" (12.7)	1.3" (33)	1/4" 
QA1L05C4LD	3.5 – 11.5 (0.4 – 1.3)	9.3 – 33.4 (1.05 – 3.77)	15.7 – 56.4 (1.77 – 6.37)	500	2.1 (1.0)	11.9" (302.3)	0.5" (12.7)	1.3" (33)	1/4" 
QA1L05C6LD	3.5 – 11.5 (0.4 – 1.3)	9.3 – 33.4 (1.05 – 3.77)	15.7 – 56.4 (1.77 – 6.37)	500	2.1 (1.0)	11.9" (302.3)	0.5" (12.7)	1.3" (33)	1/4" 

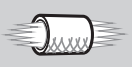
Series				
Q2	75 dBa	1/4" NPT	1/4" (6 mm)	16 cfm (450 L/Min)

Angle Air Nutrunners

Adjustable Cushion Clutch

5 & 7 Series

Durability and performance are the hallmarks of these proven winners.

Features

- Torque range: 10 – 130 in-lbs (1.7 – 14.8 Nm)
- Speeds: 600 – 1,800 rpm
- Convenient push-button reverse
- Proven quality and reliability
- Recommended for applications requiring a torque limiting clutch



5RLN2C3

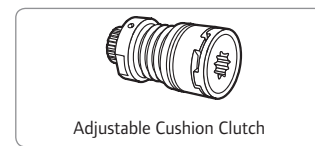

Adjustable Cushion Clutch

Service and Accessories

Manuals:

- 80167471 5 Series
- 16584047 7 Series
- 16584054

Accessories:

- Spring balancer
- Piped away exhaust kit: (5 Series) 5L-K184
(7 Series) 7L-K284
- Sockets, see form # IR-0506-016

Kits:

- Tune-up kit: 7RL-S/D-A/ T-TK1

Model	in-lbs (Nm)	in-lbs (Nm)	rpm	lbs (kg)	in (mm)	in (mm)	in (mm)	in
5C 5 SERIES LEVER START								
5RLK2C5	10 – 40 (1.14 – 4.55)	15 – 35 (1.71 – 3.98)	1,800	3.1 (1.4)	12.4" (315)	0.52" (13.2)	1.3" (33.0)	1/4" □
5RLK2C3	10 – 40 (1.14 – 4.55)	15 – 35 (1.71 – 3.98)	1,800	3.1 (1.4)	12.4" (315)	0.52" (13.2)	0.5" (12.7)	1/4" ⬡
5RLL2C5	15 – 55 (1.7 – 6.3)	20 – 55 (2.28 – 6.26)	1,300	3.1 (1.4)	12.4" (315)	0.52" (13.2)	1.3" (33.0)	1/4" □
5RLN2C3	15 – 80.5 (1.7 – 9.1)	50.4 – 110.6 (5.69 – 12.51)	600	3.1 (1.4)	13.1" (330)	0.52" (13.2)	0.5" (12.7)	1/4" ⬡
5RLN2C6	15.0 – 80.5 (1.7 – 9.1)	50.4 – 110.6 (5.7 – 12.51)	600	3.4 (1.5)	13.1" (330)	0.52" (13.2)	1.3" (33.0)	3/8" □
5C 7 SERIES LEVER START								
7RLL2C6	25 – 80 (2.84 – 9.10)	25 – 100 (2.84 – 12.51)	1,400	3.3 (1.5)	13.2" (335)	0.52" (13.2)	1.3" (33.0)	3/8" □
7RLL3C6	25 – 80 (2.84 – 9.10)	25 – 110 (2.84 – 12.51)	1,400	4.8 (2.2)	14.3" (363)	0.54" (13.7)	1.5" (38.1)	3/8" □
7RLM3C6	25 – 90 (2.84 – 10.24)	25 – 130 (2.84 – 14.79)	800	5.0 (2.3)	14.3" (363)	0.54" (13.7)	1.5" (38.1)	3/8" □

Series				
5	75 dBa	1/4" NPT	1/4" (6 mm)	16 cfm (450 L/Min)
7	79 dBa	1/4" NPT	5/16" (8 mm)	27 cfm (760 L/Min)

Angle Air Nutrunners

Stall

Q2 Series

Award-winning design delivers the performance you need.

Features

- Torque Range: 35.4 – 102.3 in-lbs (4 – 11.6 Nm)
- Speeds: 250 – 1,270 rpm
- Compact, lightweight, well-balanced design
- Contoured soft grip handle
- Low force forward reverse controls
- Torque control through pressure regulation or operator control
- Recommended for soft pull applications not requiring critical torque control



QA1L05D6LD

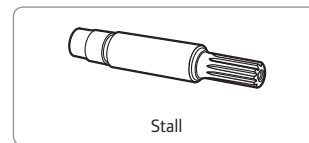

Stall

Service and Accessories

Manuals:

- 16574519
- 80167406
- 16575201, 16584062

Accessories:

- Spring balancer
- Sockets, see form # IR-0506-016
- Piped away exhaust: LG1-K284
- Vertical hanger: 7L-365

Kits:

- Inlet / Throttle / Motor kits: Q2-TK1

Model	in-lbs (Nm)	1 min. rpm	lbs (kg)	in (mm)	in (mm)	in (mm)	in
DC LEVER START							
QA1L12D4LD	35.4 (4.0)	1,270	1.5 (0.7)	8.9" (226)	0.52" (13.2)	1.3" (33)	1/4" □
QA1L12D6LD	35.4 (4.0)	1,270	1.5 (0.7)	8.9" (226)	0.52" (13.2)	1.3" (33)	3/8" □
QA1L12D1LD	35.4 (4.0)	1,270	1.5 (0.7)	8.9" (226)	0.52" (13.2)	1.3" (33)	1/4" ○
QA1L08D4LD	60.2 (6.8)	850	1.5 (0.7)	8.9" (226)	0.52" (13.2)	1.3" (33)	1/4" □
QA1L08D6LD	60.2 (6.8)	850	1.5 (0.7)	8.9" (226)	0.52" (13.2)	1.3" (33)	3/8" □
QA1L08D1LD	60.2 (6.8)	850	1.5 (0.7)	8.9" (226)	0.52" (13.2)	1.3" (33)	1/4" ○
QA1L05D4LD	102.3 (11.6)	500	1.5 (0.7)	8.9" (226)	0.52" (13.2)	1.3" (33)	1/4" □
QA1L05D6LD	102.3 (11.6)	500	1.5 (0.7)	8.9" (226)	0.52" (13.2)	1.3" (33)	3/8" □
QA1L05D1LD	102.3 (11.6)	500	1.5 (0.7)	8.9" (226)	0.54" (13.7)	1.3" (33)	1/4" ○
QA1L02D6LD	85.3 (9.7)	250	1.5 (0.7)	8.9" (226)	0.54" (13.7)	1.3" (33)	3/8" □

Series	75 dBa	1/4" NPT	1/4" (6 mm)	16 cfm (450 L/Min)
Q2	75 dBa	1/4" NPT	1/4" (6 mm)	16 cfm (450 L/Min)

Angle Air Nutrunners

Stall

5, 7 & 9 Series

Durability and performance are the hallmarks of these proven winners.

Features

- Torque Range: 40 in-lbs – 82 ft-lbs (4.6 – 111.5 Nm)
- Speeds: 300 – 1,800 rpm
- Convenient push-button reverse
- Proven quality and reliability
- Torque control through pressure regulation or operator control
- Recommended for soft pull applications not requiring critical torque control



9RSQ83

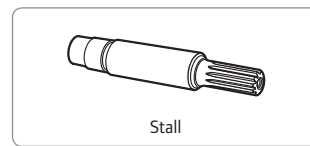

Service and Accessories

Manuals:

- P6586 5 Series
- 80167471
- P6588 7 Series
- 16574089 9 Series
- 80167521

Accessories:

- Reaction bar: 9SL-48 (9 Series)
- Hanger: 6WS-366
- Spring balancer

Kits:

- Tune-up kit: 7RL-S/D-A/T-TK1 (7 Series)

Model	in-lbs (Nm)	rpm	lbs (kg)	in (mm)	in (mm)	in (mm)	in
5 SERIES LEVER START							
5RLK2D6	40.0 (4.6)	1,800	2.7 (1.2)	10.1" (257.3)	0.5" (13)	1.3" (33.0)	3/8"
5RLL2D6	55.0 (6.3)	1,300	2.7 (1.2)	10.1" (257.3)	0.5" (13)	1.3" (33.0)	3/8"
5RLN2D6	110.6 (12.5)	600	3.1 (1.4)	10.9" (276)	0.5" (13)	1.3" (33.0)	3/8"
7 SERIES LEVER START							
7RLL3D6	100.0 (11.3)	1,400	3.3 (1.5)	11.0" (279)	0.7" (17.8)	1.5" (38.1)	3/8"
7RLM3D6	175.0 (19.8)	800	3.5 (1.6)	11.6" (295)	0.7" (17.8)	1.5" (38.1)	3/8"
7RLN3D6	265.0 (29.9)	500	3.5 (1.6)	11.6" (295)	0.7" (17.8)	1.5" (38.1)	3/8"
9 SERIES LEVER START							
9RSQ83	82.0* (111.5)	300	7.6 (3.5)	17.9" (454.2)	1.0" (24.6)	1.8" (45.7)	1/2"

* Denotes ft-lbs

Series				
5	75 dBa	1/4" NPT	1/4" (6 mm)	17 cfm (480 L/Min)
7	79 dBa	1/4" NPT	5/16" (8 mm)	27 cfm (760 L/Min)
9	82 dBa	1/2" NPT	1/2" (13 mm)	65 cfm (1841 L/Min)

Flat Angle Series

Designed for limited-access, light assembly applications.

Features

- Torque Range: 54 – 90 in-lbs (6.1 – 10.2 Nm)
- Speeds: 850 – 1,450 rpm
- Flat-angle provides needed clearance
- Angle rotates 360 degrees for ease of operation
- Torque control through pressure regulation or operator control
- Recommended for soft pull applications not requiring critical torque control



7456-D

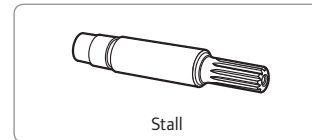

Service and Accessories

Manuals:

49999130

Accessories:

Spring balancer: BLD2
Piped-away exhaust: 44360-10
Socket spindles, see chart below

Model	in-lbs (Nm)	rpm	lbs (kg)	in (mm)	in (mm)	in (mm)	in
DC LEVER START							
7456-D	54 (6.1)	1,450	2.9 (1.3)	11.0" (279)	0.5" (12.7)	0.7" (17.8)	3/8" Female ⁽¹⁾
7453-D	90 (10.2)	850	3.4 (1.5)	12.3" (312)	0.5" (12.7)	0.7" (17.8)	3/8" Female ⁽¹⁾

Series				
Flat Angle	87 dBa	1/4" NPT	5/16" (8 mm)	23 cfm (660 L/Min)

Spindle Part Number	Hex Size in	Spindle Part Number	Hex Size in	Spindle Part Number	Hex Size in
HEX (FEMALE) SOCKET SPINDLES					
33532-1	1/4"	33532-5 ⁽¹⁾	3/8"	33532-9	1/2"
33532-2	9/32"	33532-6	13/32"	33532-10	17/32"
33532-3	5/16"	33532-7	7/16"	33532-11	9/16"
33532-4	11/32"	33532-8	15/32"	-	-

⁽¹⁾ Standard.

Angle Air Nutrunners

Stall

QA4 Series

Delivers dramatic improvements in speed, size, and durability.

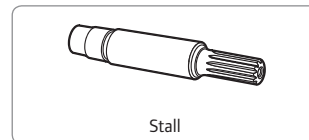

Features

- Torque Range: up to 40 ft-lbs (55 Nm)
- Speeds: 200 – 1,025 rpm
- Proven durability using world-class QE Series components
- Economical alternative to shut-off tools
- Lube-free motor
- Torque control through pressure regulation or operator control
- Recommended for soft pull applications not requiring critical torque control

Service and Accessories

Manuals:

- 80160344
- 80160336
- 80217474

Accessories:

- Mounting flanges
- Locking lever: 131655
- Long lever: 131654
- Swivel hanger: 129851
- Piped away exhaust kit: QA4-EXH-989
- Torque arms
- Sockets, see form # IR-0506-016

Kits:

- Motor kit: QA4-1-K53
- Housing kit: QA4-1-K40

Model	90 psi ft-lbs (Nm)*	1 min. 90 psi rpm	77 psi ft-lbs (Nm)	1 min. 77 psi rpm	lbs (kg)	in (mm)	in (mm)	in (mm)	in
DC LEVER START									
QA4AALD011NP25S06	8 (11)	9.6 (10)	7 (10)	1,025	2.47 (1.12)	11.1" (342)	1.28" (33)	0.50" (13)	3/8"
QA4AALD015NP25S06	11 (15)	11.8 (20)	9 (13)	800	2.47 (1.12)	11.1" (342)	1.28" (33)	0.50" (13)	3/8"
QA4AALD020NP25S06	15 (20)	15.5 (20)	13 (17)	625	2.47 (1.12)	11.1" (342)	1.28" (33)	0.50" (13)	3/8"
QA4AALD030NP28S06	22 (30)	22.9 (30)	19 (26)	425	2.63 (1.20)	11.1" (363)	1.39" (35)	0.55" (14)	3/8"
QA4AALD040NP35S06	30 (40)	30.2 (40)	25 (34)	325	3.25 (1.48)	13.2" (363)	1.71" (44)	0.69" (18)	3/8"
QA4AALD055NP35S08	40 (55)	42.8 (60)	34 (46)	200	3.88 (1.76)	14.1" (395)	1.71" (44)	0.69" (18)	1/2"

*Note: Highest recommended torque for assembly line applications. Exceeding the highest recommended torque repeatedly may result in reduced tool life.

Series				
QA4	79.3 dBa	1/4" NPT	3/8" (10 mm)	27 cfm (765 L/Min)

QA6 Series

Delivers dramatic improvements in speed, size, and durability.

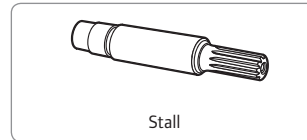

Features

- Torque Range: up to 66 ft-lbs (90 Nm)
- Speeds: 185 – 580 rpm
- Proven durability using world-class QE Series components
- Economical alternative to shut-off tools
- Lube-free motor
- Torque control through pressure regulation or operator control
- Recommended for soft pull applications not requiring critical torque control

Service and Accessories

Manuals:

- 16601072
- 16601064
- 16601056

Accessories:

- Swivel hanger: QA6-A365-S
- Sockets, see form # IR-0506-016
- Angle head boots
- Mounting flanges
- Spanner wrench: GEA40-478
- Piped away exhaust kit: QA6-K284
- Torque arms

Kits:

- Motor kit: QA6-1-K53
- Housing kit: QA6-1-K40

Model	90 psi ft-lbs (Nm)*	1 min. 90 psi rpm	77 psi ft-lbs (Nm)	1 min. 77 psi rpm	lbs (kg)	in (mm)	in (mm)	in (mm)	in
DC LEVER START									
QA6AALD030NP35S06	22 (30)	28.8 (39)	20 (27)	580	4.65 (2.11)	16.9" (429)	1.71" (44)	0.69" (18)	3/8"
QA6AALD040NP35S06	30 (40)	36.1 (49)	26 (35)	430	4.65 (2.11)	16.9" (429)	1.71" (44)	0.69" (18)	3/8"
QA6AALD040NP35S08	30 (40)	36.1 (49)	26 (35)	430	4.67 (2.12)	16.9" (429)	1.71" (44)	0.69" (18)	1/2"
QA6AALD055NP35S08	41 (55)	47.9 (65)	36 (49)	320	4.67 (2.12)	16.9" (429)	1.71" (44)	0.69" (18)	1/2"
QA6AALD070NP43S08	52 (70)	64.9 (88)	46 (62)	225	4.67 (2.12)	16.6" (422)	1.76" (45)	0.85" (22)	1/2"
QA6AALD090NP43S08	66 (90)	76 (103)	59 (80)	185	4.67 (2.12)	16.6" (422)	1.76" (45)	0.85" (22)	1/2"

*Note: Highest recommended torque for assembly line applications. Exceeding the highest recommended torque repeatedly may result in reduced tool life.

Series				
QA6	82.5 dBa	3/8" NPT	1/2" (13 mm)	36 cfm (1019 L/Min)

Angle Air Nutrunners

Stall

QA8 Series

Delivers dramatic improvements in speed, size, and durability.

Features

- Torque Range: up to 166 ft-lbs (225 Nm)
- Speeds: 90 – 570 rpm
- Proven durability using world-class QE Series components
- Economical alternative to shut-off tools
- Lube-free motor
- Torque control through pressure regulation or operator control
- Recommended for soft pull applications not requiring critical torque control

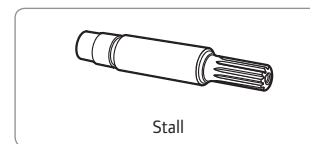

Service and Accessories

Manuals:

- 16601072
- 16601064
- 16601056

Accessories:

- Torque arms
- Swivel hanger: QA6-A365-S
- Piped away exhaust kit: QA6-K284
- Mounting flanges
- Sockets, see form # IR-0506-016

Kits:

- Housing kit: QA8-1-K40
- Motor kit: QA6-1-K53

Model	90 psi ft-lbs (Nm)*	1 min. 90 psi rpm	77 psi ft-lbs (Nm)	1 min. 77 psi rpm	lbs (kg)	in (mm)	in (mm)	in (mm)	in
DC LEVER START									
QA8AALD040NP35S06	30 (40)	38.3 (52)	26 (35)	570	4.98 (2.26)	17.8" (453)	1.71" (44)	0.69" (18)	3/8" □
QA8AALD040NP35S08	30 (40)	38.3 (52)	26 (35)	570	5.00 (2.27)	17.8" (453)	1.71" (44)	0.69" (18)	1/2" □
QA8AALD055NP35S08	41 (55)	50.1 (68)	36 (49)	425	5.00 (2.27)	17.8" (453)	1.71" (44)	0.69" (18)	1/2" □
QA8AALD070NP43S08	52 (70)	63.4 (86)	46 (62)	320	5.00 (2.27)	17.5" (445)	1.76" (45)	0.85" (22)	1/2" □
QA8AALD090NP43S08	66 (90)	79.6 (108)	59 (80)	255	5.00 (2.27)	17.5" (445)	1.76" (45)	0.85" (22)	1/2" □
QA8AALD115NP48S08	85 (115)	91.4 (124)	75 (102)	200	5.75 (2.61)	17.8" (452)	1.97" (50.0)	0.97" (25)	1/2" □
QA8AALD150NP48S08	111 (150)	121.7 (165)	98 (133)	145	6.48 (2.94)	19.2" (489)	1.97" (50.0)	0.97" (25)	1/2" □
QA8AALD200NF56S12	148 (200)	157.1 (213)	131 (178)	110	8.47 (3.84)	20.0" (508)	2.09" (53.2)	1.19" (30)	3/4" □
QA8AALD225NF56S12	166 (225)	202.1 (274)	164 (222)	90	8.47 (3.84)	20.0" (508)	2.09" (53.2)	1.19" (30)	3/4" □

*Note: Highest recommended torque for assembly line applications. Exceeding the highest recommended torque repeatedly may result in reduced tool life.

Series				
QA8	87 dBA	3/8" NPT	1/2" (13 mm)	46 cfm (1303 L/Min)

Inline Air Nutrunners

Adjustable Shut-Off

QA4 Series

Accuracy, durability, and flexibility combine to maximize productivity.

Features

- Torque range: 4.4 – 34 ft-lbs (6.0 – 46 Nm)
- Speeds: 250 – 1,050 rpm
- Adjustable shut-off clutch provides repeatability that improves joint quality
- Quick, precise shut-off limits scatter and torque reaction
- Lube-free motor
- Proven durability using world-class QE Series components
- Ergonomic grip for operator comfort
- Recommended for applications where precise torque control is required

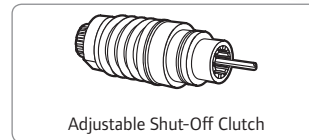

Service and Accessories

Manuals:

- 80160344
- 80160336
- 80217474

Accessories:

- Sockets, see form # IR-0506-016
- Piped away exhaust kit: QA4-EXH-989
- Cycle count port kit: 131711
- Mounting flanges
- Torque arms

Kits:

- Motor kit: QA4-1-K53
- Housing kit: QA4-1-K40
- Clutch ball kit: QA4-1-K581

Model	90 psi ft-lbs (Nm)	1 min. 90 psi rpm	77 psi ft-lbs (Nm)	1 min. 77 psi rpm	lbs (kg)	in (mm)	in (mm)	in
DC LEVER START								
QA4ASLS012NP41S06	4.4 – 8.8 (6 – 12)	1,050	4.4 – 7.4 (6 – 10)	977	3.22 (1.46)	18.3" (464)	0.81" (21)	3/8"
QA4ASLS015NP41S06	5.2 – 11.1 (7 – 15)	850	5.2 – 9.4 (7 – 12.7)	791	3.22 (1.46)	18.3" (464)	0.81" (21)	3/8"
QA4ASLS020NP41S06	7.4 – 14.8 (10 – 20)	600	7.4 – 12.5 (10 – 17)	558	3.22 (1.46)	18.3" (464)	0.81" (21)	3/8"
QA4ASLS027NP41S06	10.3 – 19.9 (14 – 27)	450	10.3 – 16.7 (14 – 22.7)	419	3.22 (1.46)	18.3" (464)	0.81" (21)	3/8"
QA4ASLS046NP41S06	14.8 – 33.9 (20 – 46)	250	14.8 – 28.0 (20 – 38)	233	3.73 (1.69)	18.8" (478)	0.91" (23)	3/8"
QA4ASLS046NP41S08	14.8 – 33.9 (20 – 46)	250	14.8 – 28.0 (20 – 38)	233	3.77 (1.71)	18.8" (478)	0.91" (23)	1/2"

Series				
QA4	79.3 dBa	1/4" NPT	3/8" (10 mm)	29 cfm (821 L/Min)

QA6 Series

Accuracy, durability, and flexibility combine to maximize productivity.

Features

- Torque range: 8.9 – 40.6 ft-lbs (12 – 55 Nm)
- Speeds: 325 – 720 rpm
- Adjustable shut-off clutch provides repeatability that improves joint quality
- Quick, precise shut-off limits scatter and torque reaction
- Lube-free motor
- Proven durability using world-class QE Series components
- Ergonomic grip for operator comfort
- Recommended for applications where precise torque control is required

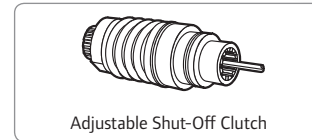

Service and Accessories

Manuals:

- 16601072
- 16601064
- 16601056

Accessories:

- Sockets, see form # IR-0506-016
- Piped away exhaust kit: QA6-K284
- Mounting flanges
- Torque arms

Kits:

- Housing kit: QA6-1-K40
- Clutch ball kit: QA6-1-K581
- Motor kit: QA6-1-K53

Model	90 psi ft-lbs (Nm)	1 min. 90 psi rpm	77 psi ft-lbs (Nm)	1 min. 77 psi rpm	lbs (kg)	in (mm)	in (mm)	in
DC LEVER START								
QA6ASLS025NP41S06	8.9 – 18.4 (12 – 25)	720	8.9 – 16.2 (12 – 22)	685	5.07 (2.30)	18.8" (478)	0.80" (20)	3/8" <input type="checkbox"/>
QA6ASLS030NP41S06	11.1 – 22.1 (15 – 30)	605	11.1 – 19.2 (15 – 26)	575	5.07 (2.30)	18.8" (478)	0.80" (20)	3/8" <input type="checkbox"/>
QA6ASLS040NP41S06	14.8 – 29.5 (20 – 40)	450	14.8 – 25.8 (20 – 35)	425	5.07 (2.30)	18.8" (478)	0.80" (20)	3/8" <input type="checkbox"/>
QA6ASLS055NP41S08	18.4 – 40.6 (25 – 55)	325	18.4 – 36.1 (25 – 49)	310	5.09 (2.31)	18.8" (478)	0.80" (20)	1/2" <input type="checkbox"/>

Series				
QA6	82.5 dBa	3/8" NPT	1/2" (13 mm)	36 cfm (1020 L/Min)

Inline Air Nutrunners

Adjustable Shut-Off

QA8 Series

Accuracy, durability, and flexibility combine to maximize productivity.



Features

- Torque range: 14.8 – 132.8 ft-lbs (20 – 180 Nm)
- Speeds: 140 – 600 rpm
- Adjustable shut-off clutch provides repeatability that improves joint quality
- Quick, precise shut-off limits scatter and torque reaction
- Lube-free motor
- Proven durability using world-class QE Series components
- Ergonomic grip for operator comfort
- Recommended for applications where precise torque control is required

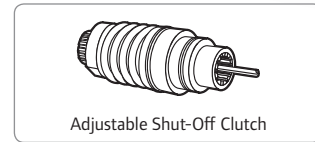

Service and Accessories

Manuals:

- 16601072
- 16601064
- 16601056

Accessories:

- Torque arm
- Sockets, see form # IR-0506-016
- Piped away exhaust kit: QA6-K284
- Mounting flanges

Kits:

- Housing kit: QA8-1-K40
- Motor kit: QA6-1-K53
- Clutch ball kit: QA6-1-K581

Model	90 psi ft-lbs (Nm)	1 min. 90 psi rpm	77 psi ft-lbs (Nm)	1 min. 77 psi rpm	lbs (kg)	in (mm)	in (mm)	in
DC LEVER START								
QA8ASLS040NP41S06	14.8 – 29.5 (20 – 40)	600	14.8 – 25.8 (20 – 35)	570	5.27 (2.39)	19.7" (502)	0.80" (20)	3/8"
QA8ASLS040NP41S08	14.8 – 29.5 (20 – 40)	600	14.8 – 25.8 (20 – 35)	570	5.29 (2.40)	19.7" (502)	0.80" (20)	1/2"
QA8ASLS055NP41S08	18.4 – 40.6 (25 – 55)	470	18.4 – 36.1 (25 – 49)	445	5.29 (2.40)	19.7" (502)	0.80" (20)	1/2"
QA8ASLS070NP41S08	25.8 – 51.6 (35 – 70)	355	25.8 – 45.7 (35 – 62)	335	5.60 (2.54)	19.9" (506)	0.94" (24)	1/2"
QA8ASLS090NP41S08	33.2 – 66.4 (45 – 90)	255	33.2 – 59.0 (45 – 80)	245	6.33 (2.87)	21.3" (542)	0.94" (24)	1/2"
QA8ASLS115NF41S08	51.6 – 84.8 (70 – 115)	215	51.6 – 75.2 (70 – 102)	205	7.50 (3.40)	21.3" (541)	2.00" (51)	1/2"
QA8ASLS150NF41S08	55.3 – 110.6 (75 – 150)	165	55.3 – 98.1 (75 – 133)	160	7.50 (3.40)	21.3" (541)	2.00" (51)	1/2"
QA8ASLS180NF41S08	66.4 – 132.8 (90 – 180)	140	66.4 – 118.0 (90 – 160)	135	7.50 (3.40)	21.3" (541)	2.00" (51)	1/2"

Series				
QA8	87 dBa	3/8" NPT	1/2" (13 mm)	46 cfm (1303 L/Min)

Inline Air Nutrunners

Remote Start Shut-Off

QA4/QA6 Series

Accuracy, durability, and flexibility combine to maximize productivity.

QA4 Features

- Torque range: 4.4 – 33.9 ft-lbs (6.0 – 46 Nm)
- Speeds: 250 – 1,050 rpm
- Slim, compact design for space-saving fixturing
- Quick, precise shut-off limits scatter and torque reaction
- Integral cycle count port
- Lube-free motor
- Proven durability using world-class QE Series components
- Recommended for applications where precise torque control is required

QA6 Features

- Torque range: 8.9 – 40.6 ft-lbs (12 – 55 Nm)
- Speeds: 315 – 700 rpm
- Slim, compact design for space-saving fixturing
- Quick, precise shut-off limits scatter and torque reaction
- Integral cycle count port
- Lube-free motor
- Proven durability using world-class QE Series components
- Recommended for applications where precise torque control is required

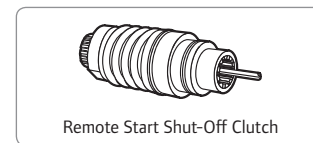

Remote Start Shut-Off Clutch

Service and Accessories

QA4 Manuals:



80160344

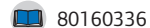

80160336



80217474

QA6 Manuals:



16601072

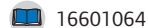

16601064



16601056

QA4 Accessories:

- Piped away exhaust kit: QA4-EXH-989
- Sockets, see form # IR-0506-016
- Mounting flanges

QA6 Accessories:

- Sockets, see form # IR-0506-016
- Piped away exhaust kit: QA6-K284
- Mounting flanges

Kits:

- Housing kit: QA4-1-K40
- Motor kit: QA4-1-K53
- Clutch ball kit: QA4-1-K581

Model	90 psi ft-lbs (Nm)	90 psi rpm	77 psi ft-lbs (Nm)	77 psi rpm	lbs (kg)	in (mm)	in (mm)	in
QA4 REMOTE START								
QA4ASRS012NF41S06	4.4 – 8.8 (6 – 12)	1,050	4.4 – 7.4 (6 – 10)	977	3.55 (1.61)	17.8" (451)	0.81" (21)	3/8"
QA4ASRS015NF41S06	5.2 – 11.1 (7 – 15)	850	5.2 – 9.4 (7 – 12.7)	791	3.55 (1.61)	17.8" (451)	0.81" (21)	3/8"
QA4ASRS020NF41S06	7.4 – 14.8 (10 – 20)	600	7.4 – 12.5 (10 – 17)	558	3.55 (1.61)	17.8" (451)	0.81" (21)	3/8"
QA4ASRS027NF41S06	10.3 – 19.9 (14 – 27)	450	10.3 – 16.7 (14 – 22.7)	419	3.55 (1.61)	17.8" (451)	0.81" (21)	3/8"
QA4ASRS046NF41S06	14.8 – 33.9 (20 – 46)	250	14.8 – 28.0 (20 – 38)	233	4.06 (1.84)	18.3" (465)	0.91" (23)	3/8"
QA4ASRS046NF41S08	14.8 – 33.9 (20 – 46)	250	14.8 – 28.0 (20 – 38)	233	4.06 (1.84)	18.3" (465)	0.91" (23)	1/2"
QA6 REMOTE START								
QA6ASRS025NF41S06	8.9 – 18.4 (12 – 25)	700	8.9 – 16.2 (12 – 22)	665	5.76 (2.61)	17.9" (454)	1.34" (34)	3/8"
QA6ASRS030NF41S06	11.1 – 22.1 (15 – 30)	585	11.1 – 19.2 (15 – 26)	555	5.76 (2.61)	17.9" (454)	1.34" (34)	3/8"
QA6ASRS040NF41S06	14.8 – 29.5 (20 – 40)	435	14.8 – 25.8 (20 – 35)	415	5.76 (2.61)	17.9" (454)	1.34" (34)	3/8"
QA6ASRS055NF41S08	18.4 – 40.6 (25 – 55)	315	18.4 – 36.1 (25 – 49)	300	5.78 (2.62)	17.9" (454)	1.34" (34)	1/2"

Series					
QA4	79.3 dBa	3/8" NPT	1/4" NPT	3/8" (10mm) x qty. 2 1/2" (13mm) x qty. 1	29 cfm (793 L/Min)
QA6	82.5 dBa	1/2" NPT	3/8" NPT	1/2" (13mm) x qty. 3	36 cfm (1020 L/Min)

QA8 Series

Accuracy, durability, and flexibility combine to maximize productivity.



Features

- Torque range: 14.8 – 132.8 ft-lbs (20 – 180 Nm)
- Speeds: 125 – 540 rpm
- Slim, compact design for space-saving fixturing
- Quick, precise shut-off limits scatter and torque reaction
- Integral cycle count port
- Lube-free motor
- Proven durability using world-class QE Series components
- Recommended for applications where precise torque control is required

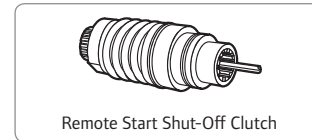

Service and Accessories

Manuals:

- 16601072
- 16601064
- 16601056

Accessories:

- Sockets, see form # IR-0506-016
- Piped away exhaust kit: QA6-K284
- Mounting flanges

Kits:

- Remote housing tune-up kit: QA6-1R-K40
- Motor kit: QA6-1-K53
- Clutch ball kit: QA6-1-K581
- Housing kit: QA8-1-K40

Model	90 psi ft-lbs (Nm)	1 min. 90 psi rpm	77 psi ft-lbs (Nm)	1 min. 77 psi rpm	lbs (kg)	in (mm)	in (mm)	in
DC REMOTE START								
QA8ASRS040NF41S06	14.8 – 29.5 (20 – 40)	540	14.8 – 25.8 (20 – 35)	515	6.03 (2.73)	18.8" (478)	1.34" (34)	3/8" □
QA8ASRS040NF41S08	14.8 – 29.5 (20 – 40)	540	14.8 – 25.8 (20 – 35)	515	6.05 (2.74)	18.8" (478)	1.34" (34)	1/2" □
QA8ASRS055NF41S08	18.4 – 40.6 (25 – 55)	425	18.4 – 36.1 (25 – 49)	405	6.05 (2.74)	18.8" (478)	1.34" (34)	1/2" □
QA8ASRS070NF41S08	25.8 – 51.6 (35 – 70)	320	25.8 – 45.7 (35 – 62)	305	6.80 (3.09)	19.0" (482)	1.69" (43)	1/2" □
QA8ASRS090NF41S08	33.2 – 66.4 (45 – 90)	230	33.2 – 59.0 (45 – 80)	220	7.53 (3.42)	20.4" (518)	1.69" (43)	1/2" □
QA8ASRS115NF41S08	51.6 – 84.8 (70 – 115)	195	51.6 – 75.2 (70 – 102)	185	8.02 (3.64)	20.4" (517)	2.00" (51)	1/2" □
QA8ASRS150NF41S08	55.3 – 110.6 (75 – 150)	150	55.3 – 98.1 (75 – 133)	145	8.02 (3.64)	20.4" (517)	2.00" (51)	1/2" □
QA8ASRS180NF41S08	66.4 – 132.8 (90 – 180)	125	66.4 – 118.0 (90 – 160)	120	8.02 (3.64)	20.4" (517)	2.00" (51)	1/2" □

Series					
QA8	87 dBa	1/2" NPT	3/8" NPT	1/2" (13mm) x qty. 3	46 cfm (1303 L/Min)

Inline Air Nutrunners

Remote Start Stall

QA4 Series

Durability and flexibility combine to maximize productivity.

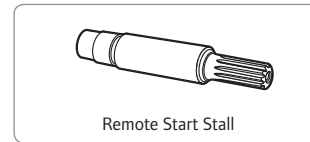

Features

- Torque Range: 8.8 – 33.9 ft-lbs (12 – 46 Nm)
- Speeds: 250 – 1,050 rpm
- Slim, compact design for space-saving fixturing
- Torque control through pressure regulation
- Lube-free motor
- Recommended for non-critical or pressure-controlled multi-spindle fixtured applications

Service and Accessories

Manuals:

- 80160344
- 80160336
- 80217474

Accessories:

Sockets, see form # IR-0506-016
Piped away exhaust kit: QA4-EXH-989
Mounting flanges

Kits:

Motor kit: QA4-1-K53
Housing kit: QA4-1-K40

Model	90 psi ft-lbs (Nm)*	77 psi ft-lbs (Nm)	90 psi ft-lbs (Nm)	1 min. 90 psi rpm	lbs (kg)	in (mm)	in (mm)	in
DC REMOTE START								
QA4ASRD012NF41S06	8.8 (12)	7.4 (10)	9.6 (13)	1050	3.55 (1.61)	17.8" (451)	0.81" (21)	3/8"
QA4ASRD015NF41S06	11.1 (15)	9.4 (12.7)	11.8 (16)	850	3.55 (1.61)	17.8" (451)	0.81" (21)	3/8" □
QA4ASRD020NF41S06	14.8 (20)	12.5 (17)	15.5 (21)	600	3.55 (1.61)	17.8" (451)	0.81" (21)	3/8" □
QA4ASRD027NF41S06	19.9 (27)	16.7 (22.7)	20.6 (28)	450	3.55 (1.61)	17.8" (451)	0.81" (21)	3/8" □
QA4ASRD046NF41S06	33.9 (46)	28 (38)	34.7 (47)	250	4.06 (1.84)	18.3" (465)	0.91" (23)	3/8" □
QA4ASRD046NF41S08	33.9 (46)	28 (38)	34.7 (47)	250	4.06 (1.84)	18.3" (465)	0.91" (23)	1/2" □

*Note: Highest recommended torque for assembly line applications. Exceeding the highest recommended torque repeatedly may result in reduced tool life.

Series					
QA4	79.3 dBa	3/8" NPT	1/4" NPT	3/8" (10mm) x qty. 2 1/2" (13mm) x qty. 1	29 cfm (793 L/Min)

QA6 Series

Durability and flexibility combine to maximize productivity.

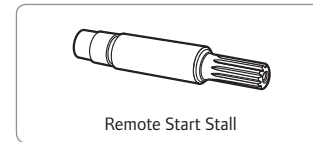

Features

- Torque Range: 18.4 – 40.6 ft-lbs (25 – 55 Nm)
- Speeds: 315 – 700 rpm
- Slim, compact design for space-saving fixturing
- Torque control through pressure regulation
- Lube-free motor
- Recommended for non-critical or pressure-controlled multi-spindle fixtured applications

Service and Accessories

Manuals:

- 16601072
- 16601064
- 16601056

Accessories:

Sockets, see form # IR-0506-016
 Piped away exhaust kit: QA6-K284
 Mounting flanges

Kits:

Housing kit: QA6-1-K40
 Motor kit: QA6-1-K53

Model	90 psi ft-lbs (Nm)*	77 psi ft-lbs (Nm)	90 psi ft-lbs (Nm)	90 psi rpm	lbs (kg)	in (mm)	in (mm)	in
DC REMOTE START								
QA6ASRD025NF41S06	18.4 (25)	16.2 (22)	19.9 (27)	700	5.76 (2.61)	17.9" (454)	1.34" (34)	3/8"
QA6ASRD030NF41S06	22.1 (30)	19.2 (26)	23.6 (32)	585	5.76 (2.61)	17.9" (454)	1.34" (34)	3/8"
QA6ASRD040NF41S06	29.5 (40)	25.8 (35)	31.7 (43)	435	5.76 (2.61)	17.9" (454)	1.34" (34)	3/8"
QA6ASRD055NF41S08	40.6 (55)	36.1 (49)	44.2 (60)	315	5.78 (2.62)	17.9" (454)	1.34" (34)	1/2"

*Note: Highest recommended torque for assembly line applications. Exceeding the highest recommended torque repeatedly may result in reduced tool life.

Series					
QA6	82.5 dBa	1/2" NPT	3/8" NPT	1/2" (13mm) x qty. 3	36 cfm (1020 L/Min)

Inline Air Nutrunners

Remote Start Stall

QA8 Series

Durability and flexibility combine to maximize productivity.

Features

- Torque Range: 29.5 – 132.8 ft-lbs (40 – 180 Nm)
- Speeds: 125 – 540 rpm
- Slim, compact design for space-saving fixturing
- Torque control through pressure regulation
- Lube-free motor
- Recommended for non-critical or pressure-controlled multi-spindle fixtured applications

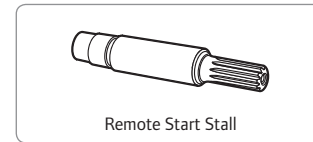

Service and Accessories

Manuals:

- 16601072
- 16601064
- 16601056

Accessories:

- Sockets, see form # IR-0506-016
- Piped away exhaust kit: QA6-K284
- Mounting flanges

Kits:

- Housing kit: QA8-1-K40
- Motor kit: QA6-1-K53

Model	90 psi ft-lbs (Nm)*	77 psi ft-lbs (Nm)	Max. Nm 90 psi ft-lbs (Nm)	1 min. 90 psi rpm	lbs (kg)	in (mm)	in (mm)	in
DC REMOTE START								
QA8ASRD040NF41S06	29.5 (40)	25.8 (35)	34.7 (47)	540	6.03 (2.73)	18.8" (478)	1.34" (34)	3/8" □
QA8ASRD040NF41S08	29.5 (40)	25.8 (35)	34.7 (47)	540	6.05 (2.74)	18.8" (478)	1.34" (34)	1/2" □
QA8ASRD055NF41S08	40.6 (55)	36.1 (49)	44.2 (60)	425	6.05 (2.74)	18.8" (478)	1.34" (34)	1/2" □
QA8ASRD070NF41S08	51.6 (70)	45.7 (62)	59.0 (80)	320	6.80 (3.09)	19.0" (482)	1.69" (43)	1/2" □
QA8ASRD090NF41S08	66.4 (90)	59.0 (80)	78.2 (106)	230	7.53 (3.42)	20.4" (518)	1.69" (43)	1/2" □
QA8ASRD115NF41S08	84.8 (115)	75.2 (102)	93.7 (127)	195	8.02 (3.64)	20.4" (517)	2.00" (51)	1/2" □
QA8ASRD150NF41S08	110.6 (150)	98.1 (133)	120.2 (163)	150	8.02 (3.64)	20.4" (517)	2.00" (51)	1/2" □
QA8ASRD180NF41S08	132.9 (180)	118.0 (160)	143.1 (194)	125	8.02 (3.64)	20.4" (517)	2.00" (51)	1/2" □

*Note: Highest recommended torque for assembly line applications. Exceeding the highest recommended torque repeatedly may result in reduced tool life.

Series					
QA8	87 dBa	1/2" NPT	3/8" NPT	1/2" (13mm) x qty. 3	46 cfm (1303 L/Min)

Pistol Grip Pulse Tools

Non-Shut-Off

Q Series

Represents the latest generation of pulse tool technology engineered with the end-user in mind.

Features

- Torque range: 15 – 141 ft-lbs (20 – 190 Nm)
- Speeds: 3,600 – 7,000 rpm
- Easy torque adjustment for quick setup
- Extremely lightweight, compact, and fast
- World-class power-to-weight ratio
- Ergonomic design provides comfortable grip, low vibration and noise, and reactionless one-handed operation
- Environmentally enhanced lube-free, dual-chamber air motor, and self-lubricating blades and cylinder reduce oil mist
- Non-shut-off tools are recommended for the majority of applications where speed and ergonomics are important



Q80P3

Service and Accessories

Manuals:

- 80206618
- 80206667
- 80213671

Accessories:

- Sockets, see form # IR-0506-016
- Spring balancer

Model		ft-lbs (Nm)	1 min. rpm	lbs (kg)	in (mm)	in (mm)	in	cmf (L/min)
DC TRIGGER START								
Q70PQ1	M6 – M8	15 – 20 (20 – 28)	7,000	1.8 (0.8)	5.2" (131)	0.9" (23)	1/4"	12 (340)
Q70P3	M6 – M8	18 – 25 (24 – 35)	7,000	1.8 (0.8)	5.2" (131)	0.9" (23)	3/8"	11 (311)
Q80PQ1	M8	18 – 25 (24 – 35)	7,000	1.9 (0.9)	5.4" (138)	0.9" (23)	1/4"	12 (340)
Q80P3	M8	25 – 36 (34 – 50)	7,000	1.9 (0.9)	5.4" (138)	0.9" (23)	3/8"	12 (340)
Q90P3	M8 – M10	35 – 48 (47 – 65)	6,500	2.1 (1.0)	5.8" (148)	0.9" (23)	3/8"	14 (396)
Q110P4	M10 – M12	48 – 74 (65 – 100)	5,500	3.0 (1.4)	6.5" (164)	1.1" (27)	1/2"	20 (566)

Model			
Q70P – Q80P	74-75 dBa	1/4" NPT	3/8" (10 mm)
Q90P – Q110P	78-81 dBa	1/4" NPT	3/8" (10 mm)

Pistol Grip Pulse Tools

Non-Shut-Off

Power Pulse Plus

Ergonomic designs offer proven performance in high- and low-torque models.

Features

- Torque range: 3 - 174 ft-lbs (4 - 235 Nm)
- Speed range: 3200 - 10,000 rpm
- Easy torque adjustment for quick setup
- High-speed, compact, lightweight design
- Excellent power-to-weight-ratio
- Two-speed trigger provides slow-speed starting and high-speed rundown
- Ergonomic design provides comfortable grip, low vibration and noise, and reactionless one-handed operation
- Non-shut-off tools are recommended for the majority of applications where speed and ergonomics are important

Service and Accessories

Manuals:
140P6

- 16574774
- 16574782
- 80167588
- 80167547

100PQ1

- 16574790
- P7073us
- P7090us
- P7072us
- 80167554
- P7074us
- 100SQ1, 500A, 700A
- P7089us
- P7079us
- P7075us
- P7062US



100PQ1



500A

Accessories:

Sockets, see form # IR-0506-016
Spring balancer

Model		ft-lbs (Nm)	1 min. rpm	lbs (kg)	in (mm)	in (mm)	in	cmf (L/min)
DC TRIGGER START								
100PQ1	M4 - M5	3 - 8 (4 - 11)	9,300	1.6 (0.7)	5.6" (142)	0.7" (18)	1/4"	12 (340)
140P6	M16	78 - 174 (105 - 235)	3,200	6.8 (3.1)	8.9" (226)	1.4" (36)	3/4"	26 (736)
DC INLINE LEVER START								
100SQ1	M4 - M5	3 - 9 (4 - 12)	10,000	1.8 (0.8)	8.9" (226)	0.8" (20)	1/4"	12 (340)
DC ANGLE LEVER START								
500A	M6 - M8	12 - 30 (16 - 41)	7,000	3.3 (1.5)	10.5" (267)	1.1" (27)	3/8"	11 (311)
700A	M8 - M10	19 - 36 (26 - 49)	5,500	4.4 (2.0)	11.2" (284)	1.1" (27)	3/8"	12 (340)

Model			
100P-140P	82 dBa	1/4" NPT	1/2" (13 mm)
100SQ-700A	76 - 78 dBa	1/4" NPT	3/8" (10 mm)

Pulse Tools

Accessories

Pulse Tune-Up Kits

Model	Motor Kit	Mechanism Kit	Repair Kit
SHUT-OFF PULSE TOOLS			
POWER PULSE PLUS			
40PSQ1	40PSQ1-TK1	40PSQ1-TKMS1	45PS-99
45PS3	45PS3-TK1	45PS3-TKMS1	45PS-99
45PSQ1	45PS3-TK1	45PS3-TKMS1	45PS-99
55PSQ1	55PS3-TK1	45PS3-TKMS1	45PS-99
90PS4	90PS4-TK1	90PS4-TKMS1	90PS-99
POWER PULSE			
1100PS4	1100PS4-K500	1100PS4-K600	700A-99
1900PS4	1900P-K500A	1900P-K600A	1900P-99
NON-SHUT-OFF PULSE TOOLS			
POWER PULSE PLUS			
46P3	46P-TK1	46P-TKMS1	46P-99
46PQ1	46P-TK1	46P-TKMS1	46P-99
Q70PQ1	Q70P-TK1	Q70P-TKMS1	N/A
Q70P3	Q70P-TK1	Q70P-TKMS1	N/A
Q80PQ1	Q70P-TK1	Q70P-TKMS1	N/A
Q80P3	Q70P-TK1	Q70P-TKMS1	N/A
Q90P3	Q70P-TK1	Q70P-TKMS1	N/A
Q110P4	Q110P-TK1	Q110P-TKMS1	N/A
130P4	130P4-TK1	130P4-TKMS1	130P4-99
140P6	140P6-TK1	140P6-TKMS1	140P6-99



Protective Boots

Literature

Catalog Name	Form Number
PULSE TOOLS	SW041107

Model	Motor Kit	Mechanism Kit	Repair Kit
NON-SHUT-OFF PULSE TOOLS			
POWER PULSE			
100PQ1	100PQ-K500	100PQ-K600	100PQ-99
280P	280PQ-K500	180PQ-K600A	180PQ-99
380PQ1	380PQ-K500	380PQ-K600A	180PQ-99
380P	380PQ-K500	380PQ-K600A	180PQ-99
500PQ1	500P-K500	500P-K600	700A-99
500P	500P-K500	500P-K600	700A-99
700P	700P-K500	500P-K600	700A-99
900P	900P-K500	900P-K600A	700A-99
1100P	1100PS4-K500	900P-K600A	700A-99
INLINE			
100SQ1	100SQ-K500	100PQ-K600	100PQ-99
180SQ1	180PQ-K500	180PQ-K600A	180PQ-99
280SQ1	280PQ-K500	180PQ-K600A	180PQ-99
380SQ1	380PQ-K500	380SQ-K600A	180PQ-99
ANGLE			
500A	500A-K500	500A-K600	180PQ-99
700A	700A-K500	700A-K600	700A-99

Protective Boots

Model	Boot Part Number
130P4	130P4-P32
46P3, 46PQ1	46P3-941
45PS3, 45PSQ1, 55PS3, 55PSQ1	55PS3-P32
70PS3	70PS3-P32
90PS4	90PS4-P32
140P6	140P6-P32
40PSQ1	40PSQ1-P32
Q70P3, Q70PQ1	Y-0189-0029-0000
Q80P3, Q80PQ1	Y-0191-0029-0000
Q90P3	Y-0188-0029-0000
Q110P4	Y-0190-0029-0000
QXP60P6, QXP70P6, QXP70Q4, QXP90P6	Y-0186-0029-0000
QXP110P8	Y-0187-0029-0000
QXP120P8	Y-0323-0029-0000
QXP140P8	Y-0341-0029-0000
QXP150P8	Y-0343-0029-0000

Lightweight Riveters

AVC and 772 Series

AVC Series Features

- Accurate and easily controlled lightweight riveters: handles 1/8" to 3/8" (3 to 10 mm) rivets
- Accurate and easily controlled tease throttle
- Standard beehive retainer: allows use of wide variety of accessories
- Built-in power regulators on A1 and B1 Models: the operator can change power on the job with no downtime
- Available with straight, pistol, and gooseneck handles

772 Series Features

- For light-duty cutting and hammering
- Unitized "easy-out" throttle valve assembly
- Furnished with two retainers for use with a wide variety of accessories



Service and Accessories

AVC Series Manuals:

- 16605925
- 03528742
- 16605933

772 Series Manuals:

- 16605859
- 03525763
- 16605867

AVC Series Accessories:

- 0.401 spring retainer: AVC10-183A
- 0.401 beehive retainer: AVC1-83
- 0.498 beehive retainer: AVC24-283
- 0.401 quick change retainer: 9510
- Rivet sets

Model	Aluminum in (mm)	Dural & Soft Iron in (mm)	in (mm)	lbs (kg)	in (mm)	in (mm)	1/min	in	cfm (L/min)
AVC SERIES - TRIGGER START									
AVC10A1	1/8" (3)	1/8" (3)	6.0" (152)	2.2 (1.0)	1.9" (48)	0.6" (14)	3200	0.401"	12 (340)
AVC10C1	1/8" (3)	1/8" (3)	6.8" (172)	2.1 (0.9)	1.9" (48)	0.6" (14)	3200	0.401"	12 (340)
AVC12A1	3/16" (5)	3/16" (5)	7.8" (197)	3.4 (1.5)	3.0" (76)	0.6" (14)	2100	0.401"	13 (360)
AVC13A1	1/4" (6)	1/4" (6)	8.8" (222)	3.7 (1.7)	4.0" (101)	0.6" (14)	1725	0.401"	13 (360)
AVC26A1*	3/8" (10)	5/16" (8)	11.3" (287)	5.1 (2.3)	6.0" (152)	0.8" (19)	1120	0.498"	14 (396)
AVC26B1*	3/8" (10)	5/16" (8)	14" (354)	7.0 (3.2)	6.0" (152)	0.8" (19)	1120	0.498"	14 (396)
772 SERIES									
772	-	-	7.38" (187)	3.6 (1.6)	2.3" (57)	0.75" (19)	3,000	0.401"	15 (425)

Model	95 dBA	1/4" NPT	5/16" (8 mm) 1/2" (13mm)*
AVC	95 dBA	1/4" NPT	5/16" (8 mm) 1/2" (13mm)*
772	95 dBA	1/4" NPT	5/16" (8 mm)

Calibration Equipment

EXTA Series – Expert Torque Analyzer

Features

- Lightweight portable unit
- Compatible with full range of Industry Standard (IS) and Smart external transducers
- Large LCD screen
- Full keypad and easy-to-navigate menus
- Full statistical capabilities
- Rechargeable battery with auto-shutdown feature



Manuals:

- 45652906 EXT Series
- 45655859
- 45654696

Model	Description	Units of Measure	Data Analysis	Number of Configurations	Languages	Recording Models
EXTA	Expert Torque Analyzer	9	Cp, Cpk, Pp, Ppk, CMK, CAM, Range, Mean, Standard Deviation	250	English, German, French, Italian, Spanish	peak, click pulse, track

Accessories

Transducers					
Industry Standard	Smart Transducers		(in-lb) ft-lb	N=m	in
	Torque only	Torque and Angle			
ROTARY					
TR2H4	-	-	(1.0 - 18)	0.10 - 2	1/4" ⌀
TR5H4	TRD5H4	TRDA5H4	(2.2 - 44)	0.25 - 5	1/4" ⌀
TR20H4	TRD20H4	TRDA20H4	(9.0 - 180)	1 - 20	1/4" ⌀
TR20S4	TRD20S4	TRDA20S4	(9.0 - 180)	1 - 20	1/4" □
TR75S6	TRD75S6	TRDA75S6	2.8 - 55	3.8 - 75	3/8" □
TR180S8	TRD180S8	TRDA180S8	6.7 - 133	9 - 180	1/2" □
TR250S12	-	-	9.2 - 185	12.5 - 250	3/4" □
TR500S12	TRD500S12	TRDA500S12	18.5 - 370	25 - 500	3/4" □
STATIONARY					
TS30S4	TSD28S4	-	1.1 - 22	1.5 - 30	1/4"
TS150S6	TSD135S6	-	5.5 - 110	7.5 - 150	3/8"
TS300S8	TSD270S8	-	11 - 221	15 - 300	1/2"
TS1000S12	TSD1000S12	-	37 - 738	50 - 1000	3/4"



Stationary transducer with joint simulator

Joint Simulators					
Model	Includes Transducer	Joint Simulator Bolt Service Kit	ft-lb	Nm	in
JKR20	No	JKS30-BKIT	0.75 - 15	1.0 - 20	1/4"
JKR75	No	JKS150-BKIT	2.8 - 55	3.8 - 75	3/8"
JKR180	No	JKS300-BKIT	6.7 - 133	9.0 - 180	1/2"
JKR500	No	JKS1000-BKIT	18.5 - 370	25.0 - 500	3/4"
STATIONARY					
JKS30	No	JKS30-BKIT	1.1 - 22	1.5 - 30	1/4"
JKS150	No	JKS150-BKIT	5.5 - 110	7.5 - 150	3/8"
JKS300	No	JKS300-BKIT	11.0 - 221	15.0 - 300	1/2"
JKS1000	No	JKS1000-BKIT	37.0 - 738	50.0 - 1000	3/4"
JKST30	TS30S4	JKS30-BKIT	1.1 - 22	1.5 - 30	1/4"
JKST150	TS150S6	JKS150-BKIT	5.5 - 110	7.5 - 150	3/8"
JKST300	TS300S8	JKS300-BKIT	11.0 - 221	15.0 - 300	1/2"
JKST1000	TS1000S12	JKS1000-BKIT	37.0 - 738	50.0 - 1000	3/4"



Rotary transducers



Calibration Equipment

EXTT Series – Expert Torque Testers

- Features
- Monitors torque, angle, time, and pulse count
 - Reads in peak, click, pulse, or track mode
 - Stores 200 time-stamped readings
 - Auto-recognition of Smart transducers
 - Seven units of measure
 - Selectable filter frequencies
 - DC tool calibration via ICS software
 - Selectable power-save settings
 - Selectable languages include English, French, German, Italian, and Spanish



Manuals:

-  45652906 EXTT Series
-  45655859
-  45654696

EXTT SERIES — EXPERT TORQUE TESTERS				
				
Model	in-lb	Nm	Rundown Adapter*	Rundown Adapter Service Kit
EXTT-1	0.88 – 8.8	0.1 – 1	ETT-RA-1	ETT-RA-1-KIT
EXTT-4	3.50 – 35	0.4 – 4	ETT-RA-4	ETT-RA-4-KIT
EXTT-12	10.6 – 106	1.2 – 12	ETT-RA-12	ETT-RA-12-KIT
EXTT-30	26.5 – 265	3.0 – 30	ETT-RA-30	ETT-RA-30-KIT

* EXTT tester includes rundown adapter, carrying case, battery charger, manuals, and a certificate of calibration. EXTA analyzer includes carrying case, battery charger, manuals, and neck strap.

Spring Balancers

Cable

BLD Series

Features

- Self-lubricating bushings
- Adjustable capacity and stroke limiting device
- Auxiliary safety suspension

Manuals:



BLD



BLD1

BMD Series

Features

- Safety device prevents dropping of load due to spring breakage (except on BMDS-2)
- Anti-friction cable guide
- Adjustable stroke-limiting device

Manuals:



BMDL4



BMDS2



BMDLL



BMDS4



BMDS-2

Model	SWL lbs (kg)	ft (m)	lbs (kg)
BLD SERIES			
BDL 1	0.9 – 2.2 (0.4 – 1.0)	5.2 (1.6)	1.3 (0.6)
BDL 2	2.2 – 4.4 (1.0 – 2.0)	5.2 (1.6)	1.3 (0.6)
BDL 3	4.4 – 6.6 (2.0 – 3.0)	5.2 (1.6)	1.5 (0.7)

Model	SWL lbs (kg)	ft (m)	lbs (kg)
BMD SERIES			
BMDS-2	2.2 – 5.5 (1.0 – 2.5)	6.5 (2.0)	4.4 (2.0)
BMDS-4	4.4 – 8.8 (2.0 – 4.0)	6.5 (2.0)	4.4 (2.0)
BMDL-4	4.4 – 8.8 (2.0 – 4.0)	8.2 (2.5)	6.4 (2.9)
BMDS-6	8.8 – 13.2 (4.0 – 6.0)	6.5 (2.0)	5.1 (2.3)
BMDL-6	8.8 – 13.2 (4.0 – 6.0)	8.2 (2.5)	7.1 (3.2)
BMDS-8	13.2 – 17.6 (6.0 – 8.0)	6.5 (2.0)	5.5 (2.5)
BMDL-8	13.2 – 17.6 (6.0 – 8.0)	8.2 (2.5)	7.7 (3.5)
BMDL-10	17.6 – 22.0 (8.0 – 10.0)	8.2 (2.5)	8.2 (3.7)
BMDL-12	22.0 – 26.5 (10.0 – 12.0)	8.2 (2.5)	8.8 (4.0)
BMDLL-4 ⁽¹⁾	4.4 – 8.8 (2.0 – 4.0)	8.2 (2.5)	6.6 (3.0)
BMDLL-6 ⁽¹⁾	8.8 – 13.2 (4.0 – 6.0)	8.2 (2.5)	7.3 (3.3)
BMDLL-8 ⁽¹⁾	13.2 – 17.6 (6.0 – 8.0)	8.2 (2.5)	7.9 (3.6)
BMDLL-10 ⁽¹⁾	17.6 – 22.0 (8.0 – 10.0)	8.2 (2.5)	8.4 (3.8)

BIDS Series

Features

- Safety device prevents dropping of load due to spring breakage
- Anti-friction cable guide
- Adjustable stroke limiting device
- Upper rotary suspension
- Safety hook
- Auxiliary safety suspension

Manuals:



BIDS



BIDS-14

Model	SWL lbs (kg)	ft (m)	lbs (kg)
BIDS SERIES			
BIDS-7	8.8 – 15.4 (4.0 – 7.0)	6.5 (2.0)	5.0 (2.26)
BIDS-10	15.4 – 22.0 (7.0 – 10.0)	6.5 (2.0)	5.5 (2.49)
BIDS-14	22.0 – 30.9 (10.0 – 14.0)	6.5 (2.0)	5.5 (2.49)
BIDS-18	30.9 – 39.7 (14.0 – 18.0)	6.5 (2.0)	6.5 (2.95)
BIDS-22	39.7 – 48.5 (18.0 – 22.0)	6.5 (2.0)	6.5 (2.95)
BIDS-26	48.5 – 55.1 (22.0 – 25.0)	6.5 (2.0)	6.5 (2.95)

⁽¹⁾ Locking type balancer.

Spring Balancers

Cable

BSD Series

Features

- Safety device prevents load dropping
- Upper suspension with rotary safety hook
- Anti-friction cable guide
- Precision-guided cable winding prevents jams
- Worm screw capacity adjustment
- Cable visible for inspection
- Cable replacement without balancer disassembly

Manuals:



Model	SWL lbs (kg)	ft (m)	lbs (kg)
BSD SERIES			
BSD-20	33.1 – 44.1 (15.0 – 20.0)	8.2 (2.5)	41.9 (19.0)
BSDL-20	33.1 – 44.1 (15.0 – 20.0)	9.85 (3.0)	42.1 (19.1)
BSDL-25	44.1 – 55.1 (20.0 – 25.0)	9.85 (3.0)	43.9 (19.9)
BSD-30	44.1 – 66.1 (20.0 – 30.0)	8.2 (2.5)	43.7 (19.8)
BSDL-35	55.1 – 77.2 (25.0 – 35.0)	9.85 (3.0)	46.1 (20.9)
BSD-40	66.1 – 88.2 (30.0 – 40.0)	8.2 (2.5)	45.9 (20.8)
BSDL-45	77.2 – 99.2 (35.0 – 45.0)	9.85 (3.0)	52.5 (23.8)
BSD-50	88.2 – 110.2 (40.0 – 50.0)	8.2 (2.5)	52.7 (23.9)
BSDL-50	88.2 – 110.2 (40.0 – 50.0)	9.85 (3.0)	52.7 (23.9)
BSD-60	110.2 – 132.3 (50.0 – 60.0)	8.2 (2.5)	56.0 (25.4)
BSDL-60	110.2 – 132.3 (50.0 – 60.0)	9.85 (3.0)	55.8 (25.3)
BSD-70	132.3 – 154.3 (60.0 – 70.0)	8.2 (2.5)	59.1 (26.8)
BSDL-70	132.3 – 154.3 (60.0 – 70.0)	9.85 (3.0)	58.9 (26.7)
BSD-80	154.3 – 176.4 (70.0 – 80.0)	8.2 (2.5)	61.3 (27.8)

Model	SWL lbs (kg)	ft (m)	lbs (kg)
BSD SERIES (CONTINUED)			
BSDL-80	154.3 – 176.4 (70.0 – 80.0)	9.85 (3.0)	61.7 (28.0)
BSD-90	176.4 – 198.4 (80.0 – 90.0)	8.2 (2.5)	63.5 (28.8)
BSDL-90	176.4 – 198.4 (80.0 – 90.0)	9.85 (3.0)	63.9 (29.0)
BSD-100	198.4 – 220.5 (90.0 – 100.0)	8.2 (2.5)	78.5 (35.6)
BSDL-100	198.4 – 220.5 (90.0 – 100.0)	9.85 (3.0)	81.1 (36.8)
BSDL-115	242.5 – 253.5 (110.0 – 115.0)	9.85 (3.0)	85.3 (38.7)
BSD-120	220.5 – 264.6 (100.0 – 120.0)	8.2 (2.5)	85.3 (38.7)
BSDL-130	253.5 – 286.6 (115.0 – 130.0)	9.85 (3.0)	88.0 (39.9)
BSD-140	264.6 – 308.6 (120.0 – 140.0)	8.2 (2.5)	92.2 (41.8)
BSDL-140	286.6 – 308.6 (130.0 – 140.0)	9.85 (3.0)	94.4 (42.8)
BSD-150	286.6 – 330.7 (130.0 – 150.0)	8.2 (2.5)	98.1 (44.5)
BSDL-150	308.6 – 330.7 (140.0 – 150.0)	9.85 (3.0)	100.5 (45.6)
BSD-165	330.7 – 363.8 (150.0 – 165.0)	8.2 (2.5)	106.3 (48.2)
BSD-80	154.3 – 176.4 (70.0 – 80.0)	8.2 (2.5)	61.3 (27.8)

Torque Reaction Arms

Bench & Floor Mounted

QTA Series



Reaction arms that set the standard for ergonomics, ease of use, and durability.

Features

- Torque capacity range from 10 – 475 Nm (7.4 – 350 ft-lbs)
- Arms up to model QTA150 utilize an Ingersoll Rand die-cast aluminum spring balancer to aid up/down movement
- Floor mounted models QTA270 and QTA475 use Ingersoll Rand air cylinders and regulator to assist in up/down travel
- QTA150 arm can be adjusted to mount to either a bench or the floor
- Anodized aluminum on bench-mounted arms delivers toughness in a lightweight design
- Simple, proven architecture makes for trouble-free set-up and use
- Arms up to QTA100 include a standard inline tool holder
- Cable/air line clips keep work area organized

Service and Accessories

Manuals:

-  45546959
-  45546942
-  45546967

Accessories:

- QTA tool holders
- Upper pole clamp and inverse mounting kit available for bench-only models



	Torque Capacity	Weight Capacity	Max Working Reach	Approx. Vertical Travel	Overall Height	Mounting Style	Movement Style
Model	Nm (ft-lbs)	lbs (kg)	in (mm)	in (mm)	in (mm)		
QTA010	10 (7.4)	2.64 (1.20)	15" (381)	13.0" (330)	27.8" (706)	Bench	Spring bal
QTA020	20 (14.8)	5.00 (2.27)	20" (508)	14.5" (368)	31.8" (808)	Bench	Spring bal
QTA040	40 (29.5)	6.50 (2.95)	25" (635)	17.5" (445)	39.7" (1008)	Bench	Spring bal
QTA100	100 (73.8)	8.00 (3.63)	30" (762)	17.5" (445)	39.7" (1008)	Bench	Spring bal
QTA150	150 (110.6)	10.00 (4.54)	52" (1321)	22.0" (559)	78.7" (2000)	Bench/Floor	Spring bal
QTA270	270 (199)	22.00 (10.0)	60" (1524)	18.8" (477)	78.7" (2000)	Floor	Air cylinders
QTA475	475 (350)	50.60 (23.0)	79" (2007)	23.2" (590)	78.7" (2000)	Floor	Air cylinders

Bench Mounted Arm Accessories

Model	QTA010	QTA0120	QTA040	QTA100
Inverse Mounting Kit	IMK010	IMK020	IMK100	IMK100
Upper Pole Clamp	PUC010	PUC020	PUC100	PUC100

Tool Holders

QA/QE Series & Generic Styles

Holders for QTA Torque Arms

Select from a wide variety of options to ensure that the tool is correctly and safely secured to the torque arm.

Features

- Generic holders clamp to the Ingersoll Rand tools or a competitive model
- Threaded tool holder (1/4" NPT) for low-torque air tools
- For Ingersoll Rand QA & QE Series tools, please refer to the chart below to select the proper holder
- QA/QE specific holders can be mounted horizontally or vertically based on your application needs

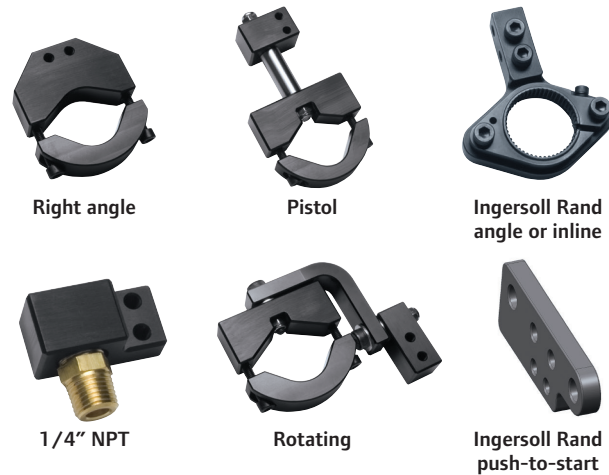

TORQUE ARMS				
Tool Holder	QTA010	QTA020	QTA040	QTA100
GENERIC CLAMP STYLE TOOL HOLDERS				
Inline (included with arm)	ITC010-1C	ITC040-1C	ITC040-1C	ITC100-1C
Right angle	ATC010-1C	ATC040-1C	ATC040-1C	ATC100-1C
Pistol	PTC010-1C	PTC040-1C	PTC040-1C	N/A
Rotating	RTC010-1C	RTC040-1C	RTC040-1C	N/A
1/4" NPT	NTC010-1T	N/A	N/A	N/A

Generic Tool holders are not available for arms 150 Nm and above

Flange mounting is recommended for inline tools with torque capacity above 40 Nm

Please note the tool diameter range for generic holders:

QTA010: 25 – 40 mm (1" – 1.57")
 QTA020 / QTA040 / QTA100:
 28 – 52 mm (1.1" – 2")

TORQUE ARMS								
TOOLS	QTA010	QTA020	QTA040	QTA100	QTA150	QTA270	QTA475	
INGERSOLL RAND QA SERIES AND QE SERIES TOOL HOLDERS								
QE4 (non-push to start)	N/A	CTC040-K1B	CTC040-K1B	N/A	N/A	N/A	N/A	
QE4 (push to start)	CTC040-K1P	CTC040-K1P	CTC040-K1P	N/A	N/A	N/A	N/A	
QE6	N/A	CTC040-K2B	CTC040-K2B	CTC100-K2B	N/A	N/A	N/A	
QE8 (using bolt-on flange GEM120-K48)	N/A	N/A	N/A	CTC100-K2B	CTC150-K2B	N/A	N/A	
QE8 (using integrated flanged gearcase)	N/A	N/A	N/A	CTC100-K3B	CTC150-K3B	CTC270-K3B	N/A	
QE8 (230 Nm inline)	N/A	N/A	N/A	N/A	N/A	CTC270-K4B	N/A	
QE8 (400 Nm angle)	N/A	N/A	N/A	N/A	N/A	N/A	CTC475-K5B	
QA4 (angle)	N/A	CTC040-K6B	CTC040-K6B	CTC100-K6B	N/A	N/A	N/A	
QA4 (27 Nm max inline) & QA6	N/A	CTC040-K1B	CTC040-K1B	CTC100-K1B	N/A	N/A	N/A	
QA4 (46 Nm inline)	N/A	N/A	N/A	CTC100-K2B	N/A	N/A	N/A	
QA8 (150 Nm max angle, 55 Nm max inline)	N/A	N/A	CTC040-K1B	CTC100-K1B	CTC150-K2B	N/A	N/A	
QA8 (above 150 Nm angle, above 55 Nm inline)	N/A	N/A	N/A	CTC100-K2B	CTC150-K3B	CTC270-K3B	N/A	

Note: Every Ingersoll Rand QE- or QA-specific tool holder listed in the table above accepts both angle and inline tools but requires an integrated flanged gear case or bolt-on mounting flange to attach the tool holder to the tool. If your tool came with mounting style "P," "R," or "J," order Part No. 15E4-K48 for any Ingersoll Rand-specific tool holder that ends with "1B." Order Part No. GEM120-K48 for any Ingersoll Rand-specific tool holder that ends with "2B." Order Part No. QA4-K48 for any Ingersoll Rand-specific tool holder that ends with "6B."

Workstations & Torque Tubes

Light-Duty Workstations





These steel-constructed, lightweight workstations offer the operator flexibility while supporting the tool weight. Add a torque absorber rod to help relieve minor torque reaction.

Model	Description
IRBS3-E0	Basic station (no absorber)
IRBS3-N30	Air tool station with torque absorber
IRBS3-E30	Electric tool station with torque absorber

Note: Workstations do not include tool, spring balancer, air hose, or FRL. All must be purchased separately.



Torque Tubes

Model	Description	 ft-lbs (Nm)	 lbs (kg)	 lbs (kg)	 in (mm)
54044227	IRZ-TT-100	74 (100)	60 (27)	40 (18)	20" (508)
54041819	IRZ-TT-250	184 (250)	60 (27)	50 (23)	24" (610)
54044417	IRZ-TT-500*	368 (500)	400 (182)	75 (34)	36" (914)

* Requires carriage mount.
See form # MHD55226 for more details.

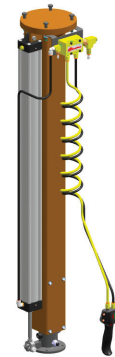

Spindle Accessories

Allen Bits

Part Number	Size
1" STANDARD	
1/8DBAL-E	1/8"
9/64DBAL-E	9/64"
5/32DBAL-E	5/32"
3/16DBAL-E	3/16"
1/4dbal-E	1/4"
2" POWER MAGNETIC	
1/16HXAL-E	1/16"
5/64HXAL-E	5/64"
3/32HXAL-E	3/32"
7/64HXAL-E	7/64"
1/8HXAL-E	1/8"
9/64HXAL-E	9/64"
5/32HXAL-E	5/32"
3/16HXAL-E	3/16"
7/32HXAL-E	7/32"
1/4HXAL-E	1/4"
2" METRIC POWER MAGNET	
1.5HXAL-M	1.5 mm
2HXAL-M	2 mm
2.5HXAL-M	2.5 mm
3HXAL-M	3 mm
4HXAL-M	4 mm
5HXAL-M	5 mm
HXAL-M	6 mm
7HXAL-M	7 mm
8HXAL-M	8 mm

Slotted Bits

Part Number	Size
1" STANDARD	
T10DBTXR	T10
T15DBTXR	T15
T20DBTXR	T20
T25DBTXR	T25
2" POWER BITS	
6HXSL	6
8HXSL	8
10HXSL	10

Magnetic Nutsetters 2" power bits

Part Number	Size
STANDARD	
5/32HXNS-E	5/32"
3/16HXNS-E	3/16"
7/32HXNS-E	7/32"
1/4HXNS-E	1/4"
9/32HXNS-E	9/32"
5/16HXNS-E	5/16"
11/32HXNS-E	11/32"
3/8HXNS-E	3/8"
7/16HXNS-E	7/16"
1/2HXNS-E	1/2"
METRIC	
5.5HXNS-M	5.5 mm
6HXNS-M	6 mm
7HXNS-M	7 mm
8HXNS-M	8 mm
9HXNS-M	9 mm
10HXNS-M	10 mm
11HXNS-M	11 mm
12HXNS-M	12 mm
13hxns-M	13 mm

Phillips Bits

Part Number	Size
1" STANDARD	
1DBPH	1
2DBPH	2
2" POWER BITS	
1HXPH	1
2HXPH	2
3HXPH	3
3" POWER BITS	
2HXPH3L	2

Torx Bits 2" power bits

Part Number	Size
1" STANDARD	
6DBSL	6
8DBSL	8
2" POWER BITS	
T5HXTX	T5
T6HXTX	T6
T7HXTXR	T7
T8HXTXR	T8
T9HXTXR	T9
T10HXTXR	T10
T15HXTXR	T15
T20HXTXR	T20
T25HXTXR	T25
T30HXTXR	T30
T40HXTXR	T40

Spindle Accessories

Rivet Sets

Part Number	Ø A in (mm)	Ø B in (mm)	L in (mm)	Style
AV1-22C-6	0.401" (10.2)	-	3.94" (100)	5 mm brazier head
AV1-22H-6	0.401" (10.2)	-	3.94" (100)	5 mm universal head
AV1-22B-8	0.401" (10.2)	-	3.94" (100)	6 mm round head
AV1-22B-10	0.401" (10.2)	-	3.94" (100)	8 mm round head
AV1-126D	0.401" (10.2)	0.98" (25)	3.62" (92)	Flush head
AV24-126D	0.498" (12.7)	0.98" (25)	3.23" (82)	Flush head
AV1-22S-16	0.401" (10.2)	0.51" (13)	3.98" (101)	Soft blank 1
AV1-22S-20	0.401" (10.2)	0.63" (16)	3.98" (101)	Soft blank 1
AV1-22S-24	0.401" (10.2)	0.75" (19)	3.98" (101)	Soft blank 1
AV1-22S-28	0.401" (10.2)	0.87" (22)	3.98" (101)	Soft blank 1
AV24-222S-26	0.498" (12.7)	0.83" (21)	3.23" (82)	Soft blank 2
AV24-222S-38	0.498" (12.7)	1.18" (30)	3.23" (82)	Soft blank 2

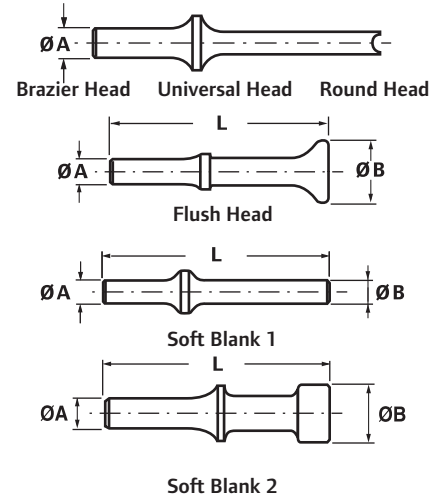

Drive Guides and Magnetic Bit Holders



Part Number	Size
3HXDRGD	3" drive guide
2HXMGBH	2" bit holder
3HXMGBH	3" bit holder

Hex to Square Adapters



Model	Size
1/4HXSQAD	1/4" sq
3/8HXSQAD	3/8" sq

Power Screwdriver Adapters

Part Number	Bit Size	Square Drive
2U-812	5/16" square	3/8"
4U-812	5/16" square	1/2"
POWER SQUARE INSERT BIT FOR POWER ADAPTERS		
SPB082-5	Phillips bit	2
SPB083-5	Phillips bit	3
SPB084-5	Phillips bit	4

Power Universal Joints



Part Number	Input Drive (Square)	Output Drive (Square)
J3	3/8"	3/8"
J4	1/2"	1/2"
J6	3/4"	3/4"

Power Socket Adapters



Part Number	Drive Size Female	Male
A2F3M	1/4"	3/8"
A3F2M	3/8"	1/4"
A3F4M	3/8"	1/2"
A4F3M	1/2"	3/8"

Power Driver Extensions

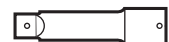

Part Number	Drive (Square)	Length
E33H	3/8"	3
E36H	3/8"	6
E43H	1/2"	3
E45H	1/2"	5
E63H	3/4"	3

Please see the Sockets brochure, form # IR-0506-016, for complete line of impact sockets.

Other Accessories

Ergo Grips / Bio Grips / Comfort Grips

Part Number	Used With:
ERGO GRIPS	
SEG3A-IR	Series 1
SEG4-IR	Series 41 (1700 rpm or less)
SEG4H-IR	Series 41 (over 1700 rpm)
REPLACEMENT FOAM GRIP KITS	
SEG3A-CGK	For SEG3 models
SEG4-CGK	For SEG4 models
BIO BRACE	
SBB4-AR41	Series 41 (1700 rpm or less)
SBB4-QE2	QE2
SBB4-VS	VersaTec
COMFORT GRIPS	
CG-6X8	6" x 8" sheet with tape

Lubricants

Part Number	Used With:
CLASS 1 #10 OILS FOR AIR TOOLS	
10Z4	4 oz oil
10P	1 pt oil
10G	1 gal oil
10G55	55 gal oil
GREASE	
23-1 LB	#23 - 1 lb - drill gearing
28 1 LB	#28 - 1 lb - SD gearing and clutches
28 8 LB	#28 - 8 lb - SD gearing and clutches
66 1 LB	#66 - 1 lb - slow-speed angle heads
66 8 LB	#66 - 8 lb - slow-speed angle heads
67-4T	#67 - 4 oz tube - high-speed angle heads
GTH-1	grease gun for 4 oz tube
67-1 LB	#67 - 1 lb - high-speed angle heads
67 8 LB	#67 - 8 lb - high-speed angle heads
68-1LB	#68 - 1 lb - Coupling splines

360° Swivel Air Inlets

Part Number	Inlet	CFM	Type
ASA-1/4	0-25	1/4"	Adjustable
ASC-1/4	0-33	1/4"	Non-marring
AS-3/8	0-45	3/8"	Standard
AS-1/2	0-65	1/2"	Standard

Angle Head Boots

25 mm	28 mm	35 mm	43 mm	48 mm	56 mm
131996	131995	131997	GEA40-172	GEA40-173	GEA240-173

Based on tool angle head diameter



Polyurethane Coil Hoses

Part Number	Description
P14-10	1/4" x 10' polyurethane coil hose, (1) 1/4" rigid, (1) 1/4" swivel fitting
P14-20	1/4" x 20' polyurethane coil hose, (1) 1/4" rigid, (1) 1/4" swivel fitting
P14-30	1/4" x 30' polyurethane coil hose, (1) 1/4" rigid, (1) 1/4" swivel fitting
P38-10	3/8" x 10' polyurethane coil hose, (1) 3/8" rigid, (1) 3/8" swivel fitting
P38-20	3/8" x 20' polyurethane coil hose, (1) 3/8" rigid, (1) 3/8" swivel fitting
P38-30	3/8" x 30' polyurethane coil hose, (1) 3/8" rigid, (1) 3/8" swivel fitting
P12-10R	1/2" x 10' polyurethane coil hose, (2) 1/2" reusable swivel fittings
P12-20R	1/2" x 20' polyurethane coil hose, (2) 1/2" reusable swivel fittings
P12-30R	1/2" x 30' polyurethane coil hose, (2) 1/2" reusable swivel fittings

Clutch Selections

Air Screwdrivers & Nutrunners

Selection of the appropriate clutch arrangement for your application is one of the first critical steps in specification. IR offers four basic types — adjustable precision shut-off, adjustable cushion clutch, positive jaw, and stall. The following introduction, coupled with the “Types of Joints” table on the following page, will help you define your requirements.

Adjustable Precision Shut-Off Clutch

Designed for critical fastening applications involving plastics, composites, or metals that require precise torque control. Automatic shut-off reduces air consumption and torque reaction.

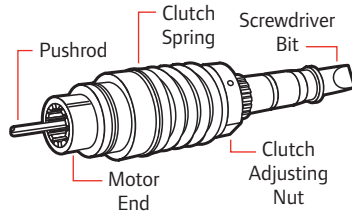

Positive Jaw Clutch

Designed for applications where driving torque may exceed final seating torque as in wood and self-tapping applications. Applied torque is controlled by the operator and can be limited by regulating air line pressure.

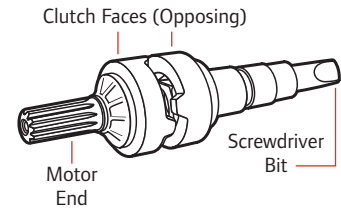

Adjustable Cushion Clutch

Steel balls rolling between indented plates provide smooth disengaging at preset torque while minimizing vibration to the operator. Very good general-purpose torque limiting clutch.

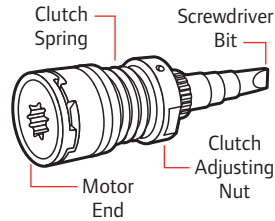

Stall

Designed for soft pull applications in wood and other materials not requiring critical torque control. Applied torque is controlled by the operator and can be limited by regulating air line pressure.

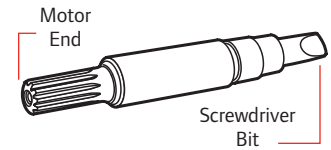

Clutch Selection Chart

TYPES OF JOINTS					
	Free Running-Slam (Hard Drive)	Compressing Gaskets (Slow Draw)	Self-Tapping Screws	Sheet Metal Screws	Wood Screws
Select the Clutch to Fit Your Job	 Resistance low at start and during rundown but peaks suddenly as bolt head seats.	 Turning resistance gradually increases as squeeze progresses to final turn.	 Initial resistance high through tapping travel, easing off until sudden (B) or gradual (A) stop.	 Starting torque builds until penetration made, then resistance slacks off until head seats.	 Low resistance at start builds gradually through entire rundown until head seats.
Adjustable Precision Shut-Off Clutch	EXCELLENT for all screw sizes where precise torque control is required.	BEST for all screw sizes where precise torque control is required.	BEST for all screw sizes except where tapping torque exceeds final torque.	EXCELLENT for all size screws — not suitable if tapping torque exceeds stripping torque.	Not recommended.
Adjustable Cushion Clutch	VERY GOOD for most screw sizes where torque control is IMPORTANT.	VERY GOOD for most screw sizes where torque control is IMPORTANT.	VERY GOOD for all screw sizes where tapping torque does not exceed final torque.	GOOD for most screws where final torque exceeds tapping torque.	Not recommended.
Positive Jaw Clutch	FAIR for all sizes where close torque control is not required.	GOOD for most screws where close torque control is not required.	GOOD where tapping torque greatly exceeds final torque.	VERY GOOD where sheets are not aligned — GOOD where tapping torque is higher than final torque.	BEST for all screw sizes.
Stall	GOOD for all screw sizes in hands of experienced operators.	GOOD for large and medium screws — must be adjusted to run rather slowly for small screws.	Not recommended unless stripping torque is considerably higher than tapping torque.	Not recommended unless stripping torque is considerably higher than tapping torque.	GOOD for large and medium screws — must be adjusted to turn slowly for small screws.

Torque Table Guide

*Suggested Tightening
Torque Values for Nonferrous
Threaded Fasteners*

Torque Table

The following suggested tightening torques provide an excellent starting point for determining torque requirements. Remember, you may need to increase or reduce these numbers based on the individual joint.

Bolt Size	18-8 Stainless Steel	Brass	Silicon Bronze	Aluminum 2024-T4	316 Stainless Steel	Monel	Nylon
VALUES (IN-LBS)							
2 – 56	2.5	2.0	2.3	1.4	2.6	2.5	0.44
2 – 64	3.0	2.5	2.8	1.7	3.2	3.1	
3 – 48	3.9	3.2	3.6	2.1	4.0	4.0	
3 – 56	4.4	3.6	4.1	2.4	4.6	4.5	
4 – 40	5.2	4.3	4.8	2.9	5.5	5.3	1.19
4 – 48	6.6	5.4	6.1	3.6	6.9	6.7	
5 – 40	7.7	6.3	7.1	4.2	8.1	7.8	
5 – 44	9.4	7.7	8.7	5.1	9.8	9.6	
6 – 32	9.6	7.9	8.9	5.3	10.1	9.8	2.14
6 – 40	12.1	9.9	11.2	6.6	12.7	12.3	
8 – 32	19.8	16.2	18.4	10.8	20.7	20.2	4.30
8 – 36	22.0	18.0	20.4	12.0	23.0	22.4	
10 – 24	22.8	18.6	21.2	13.8	23.8	25.9	6.61
10 – 32	31.7	25.9	29.3	19.2	33.1	34.9	8.20
1/4" – 20	75.2	61.5	68.8	45.6	78.8	85.3	16.00
1/4" – 28	94.0	77.0	87.0	57.0	99.0	106.0	20.80
5/16" – 18	132.0	107.0	123.0	80.0	138.0	149.0	34.90
5/16" – 24	142.0	116.0	131.0	86.0	147.0	160.0	
3/8" – 16	236.0	192.0	219.0	143.0	247.0	266.0	
3/8" – 24	259.0	212.0	240.0	157.0	271.0	294.0	
7/16" – 14	376.0	317.0	349.0	228.0	393.0	427.0	
7/16" – 20	400.0	327.0	371.0	242.0	418.0	451.0	
1/2" – 13	517.0	422.0	480.0	313.0	542.0	584.0	
1/2" – 20	541.0	443.0	502.0	328.0	565.0	613.0	
9/16" – 12	682.0	558.0	632.0	413.0	713.0	774.0	
9/16" – 18	752.0	615.0	697.0	456.0	787.0	855.0	
5/8" – 11	1110.0	907.0	1030.0	715.0	1160.0	1330.0	
5/8" – 18	1244.0	1016.0	1154.0	798.0	1301.0	1482.0	
3/4" – 10	1530.0	1249.0	1416.0	980.0	1582.0	1832.0	
3/4" – 16	1490.0	1220.0	1382.0	958.0	1558.0	1790.0	
7/8" – 9	2328.0	1905.0	2140.0	1495.0	2430.0	2775.0	
7/8" – 14	2318.0	1895.0	2130.0	1490.0	2420.0	2755.0	
1" – 8	3440.0	2815.0	3185.0	2205.0	3595.0	4130.0	
1" – 14	3110.0	2545.0	2885.0	1995.0	3250.0	3730.0	
1-1/8" – 7	413.0 ft-lbs	337.0 ft-lbs	383.0 ft-lbs	265.0 ft-lbs	432.0 ft-lbs	499.0 ft-lbs	
1-1/8" – 12	390.0 ft-lbs	318.0 ft-lbs	361.0 ft-lbs	251.0 ft-lbs	408.0 ft-lbs	470.0 ft-lbs	
1-1/4" – 7	523.0 ft-lbs	428.0 ft-lbs	485.0 ft-lbs	336.0 ft-lbs	546.0 ft-lbs	627.0 ft-lbs	
1-1/4" – 12	480.0 ft-lbs	349.0 ft-lbs	447.0 ft-lbs	308.0 ft-lbs	504.0 ft-lbs	575.0 ft-lbs	
1-1/2" – 6	888.0 ft-lbs	727.0 ft-lbs	822.0 ft-lbs	570.0 ft-lbs	930.0 ft-lbs	1064.0 ft-lbs	
1-1/2" – 12	703.0 ft-lbs	575.0 ft-lbs	651.0 ft-lbs	450.0 ft-lbs	732.0 ft-lbs	840.0 ft-lbs	

This table is offered as the suggested maximum torquing values for threaded products and is only a guide. Actual tests were conducted on dry or near-dry products. Mating parts were wiped clean of chips and foreign matter. A lubricated bolt requires less torque to attain the same clamping force as a non lubricated bolt. All values shown on chart except for nylon represent a safe working torque; in the case of nylon only, the figures represent breaking torque.



Ingersoll Rand (NYSE:IR) advances the quality of life by creating comfortable, sustainable and efficient environments. Our people and our family of brands—including Club Car®, Ingersoll Rand®, Thermo King® and Trane®—work together to enhance the quality and comfort of air in homes and buildings; transport and protect food and perishables; and increase industrial productivity and efficiency. We are a \$12 billion global business committed to a world of sustainable progress and enduring results.



www.ingersollrandproducts.com

Distributed by:

Ingersoll Rand, IR and the IR logo are trademarks of Ingersoll Rand, its subsidiaries and/or affiliates. All other trademarks are the property of their respective owners.

Nothing contained on these pages is intended to extend any warranty or representation, expressed or implied, regarding the product described herein. Any such warranties or other terms and conditions of sale of products shall be in accordance with Ingersoll Rand's standard terms and conditions of sale for such products, which are available upon request.

Product improvement is a continuing goal at Ingersoll Rand. Designs and specifications are subject to change without notice or obligation.