

TROUBLESHOOTING TIPS – Q & A

Camera will not connect to my Wi-Fi network

- Make sure the LED is blinking blue. If the LED is blinking red, you will need to press and hold Reset Button located behind the cover on the side of the camera. (see the Resetting & SD Card section)
- Make sure the Wi-Fi network is a 2.4GHz network, device will not connect to a 5GHz network.
- Test your Wi-Fi network with other devices such as your phone or computer to make sure it is operating properly.
- The Wi-Fi connection may be out of range during pairing. Use your phone to check range, it is recommended to have at least 2 signal bars showing for proper connection.
- Your Wi-Fi network password is case sensitive, make sure you are entering it correctly.

The camera is off-line

- There could be a temporary issue with your Internet connection (e.g., service disruption). Please try again in a few minutes.
- Make sure your Wi-Fi router is turned On.
- The camera may not have power to it, make sure the wall switch or breaker is in the On position.
- The camera may have been disconnected from your Wi-Fi network, press and hold Reset Button (see the Resetting & SD Card section) until you see a blinking blue LED and hear an audible tone.
- Make sure the camera is getting a good signal from your Wi-Fi router. Use your phone to check range, it is recommended to have at least 2 signal bars showing for proper connection.

What do the blinking LEDs mean?

- Blinking BLUE = Pairing Mode
- Solid RED = No Internet
- Blinking RED = No WiFi Connection
- Solid BLUE = Connected to Internet

Live video stream is slow to load

Camera streaming issues may be caused by any of the following:

- Your phone's cellular connection, which is reliant on mobile coverage and signal reception is slow.
- Limited Internet bandwidth at home, for example, other video streaming services running at the same time on your network can cause congestion slowing down the Internet upload and download speeds.
- Wi-Fi reception may not be stable or work reliably if the camera's Wi-Fi signal strength is less than 2 signal bars. You may need to install a Wi-Fi repeater or extender to boost the Wi-Fi signal.

How to soft reset my camera?

- You can soft reset your camera by cycling the power Off and On. You will hear an audible tone and the status LED should blink red then change to a solid blue in about 1 minute. If it does not turn blue after a minute, please go through the setup process again to reconnect to your Wi-Fi network.

How to hard reset my camera?

- Press and hold Reset Button located behind the cover on the side of the camera (see the Resetting & SD Card section) until you see a blinking blue LED and you hear an audible tone.

My camera is not recording?

- Make sure Record Switch is turned On in app, under SD Card Settings. This is located in the Settings menu on the upper right corner in the control panel.
- Make sure that the micro-SD card is installed correctly. To confirm the camera is recognizing the micro-SD card, go to the SD Card Settings in the Settings menu and make sure micro-SD Card Capacity menu shows Total Capacity, Used and Free Space. If this does not appear you may consider reformatting the micro-SD card. WARNING: Reformatting micro-SD card will delete all videos stored on card. Please go through the trouble shooting section before doing so or contact our Customer Support Team.

How do I set my camera to Event or Continuous Recording?

- In the Settings menu under SD Card Settings make sure Record Switch is turned On and then select Event Recording or Continuous Recording.

How can I check the available space on my SD Card?

In the Settings menu under SD Card Settings, you will see Used Space and Free Space. Note: Camera will not support micro-SD cards greater than 128GB.

What happens when my micro-SD card reaches full capacity?

Once the micro-SD card reaches full capacity, new videos will start rewriting (deleting) over the oldest videos.

Can I use a new micro-SD card if I do not want to record over existing videos?

Yes, you can use a new micro-SD card if you do not want to record over existing videos by removing the side cover on the camera and replacing the exiting micro-SD card with a new one as long as it does not exceed 128GB. Once this is completed

TROUBLESHOOTING TIPS – Q & A

you will need to format the micro-SD card by going to the SD Card Settings in the Settings menu and pressing Format SD Card then Confirm. WARNING: Reformatting micro-SD card will delete all content stored on card.

POSITIONING MOTION SENSOR

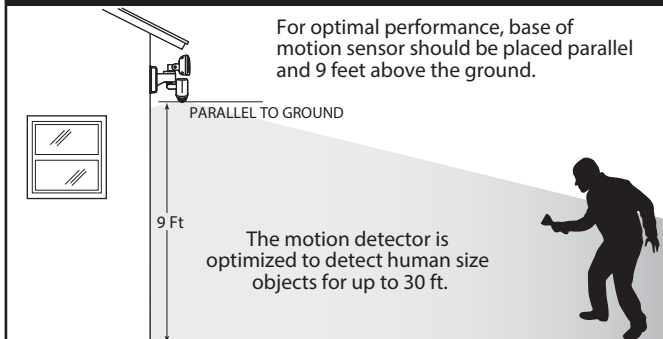

ENABLING SMART FEATURES

DOWNLOAD AND INSTALL THE FEIT ELECTRIC APP

Search for the Feit Electric App in the App Store or Google Play Store.

Download and install the Feit Electric App on your smart device.



SET UP THE FLOOD LIGHT CAMERA USING THE FEIT ELECTRIC APP

- Check to be sure the flood light camera is in pairing mode. The BLUE indicator light must be blinking rapidly to connect. If not already blinking, press and hold the Reset Button until you hear an audible tone. Use the Feit App to complete the set up.
- Tap Add Device or the + sign, then select Flood Light Camera and confirm. You will be prompted to enter your Wi-Fi network and password.

Be sure to connect to a 2.4 GHz Wi-Fi network that covers your installation location.

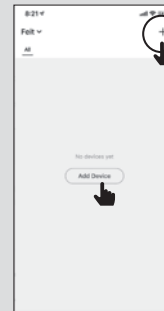

OPTIONAL – CONNECT TO GOOGLE ASSISTANT OR ALEXA USING THE IN APP GUIDE

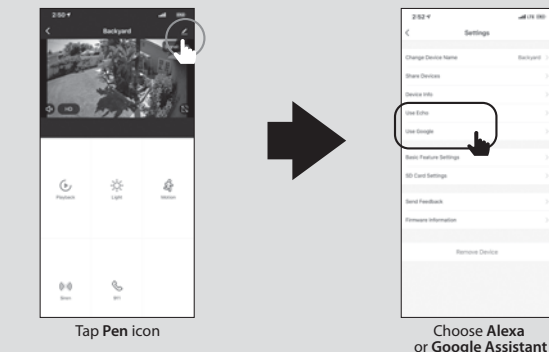

Need Help?

FAQs and the latest versions of user guides can be found at feit.com/help and feit.com/smart.

To reach customer support please visit feit.com/contact-us

MODEL SEC3000/CAM

ITM. / ART. 1355300



Flood Light Security Camera Installation Guide



IMPORTANT, RETAIN FOR FUTURE REFERENCE: READ CAREFULLY

This device complies with part 15 of the FCC Rules. Operation is subject to the following two conditions: (1) This device may not cause harmful interference, and (2) this device must accept any interference received, including interference that may cause undesired operation.

Note: This equipment has been tested and found to comply with the limits for a Class B digital device, pursuant to Part 15 of the FCC Rules. These limits are designed to provide reasonable protection against harmful interference in a residential installation. This equipment generates, uses and can radiate radio frequency energy and, if not installed and used in accordance with the instructions, may cause harmful interference to radio communications.

However, there is no guarantee that interference will not occur in a particular installation. If this equipment does cause harmful interference to radio or television reception, which can be determined by turning the equipment off and on, the user is encouraged to try to correct the interference by one or more of the following measures: Reorient or relocate the receiving antenna. Increase the separation between the equipment and receiver. Connect the equipment into an outlet on a circuit different from that to which the receiver is connected. Consult the dealer or an experienced radio/TV technician for help.

Warning: Changes or modifications to this unit not expressly approved by the part responsible for compliance could void the user's authority to operate the equipment.

FCC Radiation Exposure Statement

The device has been evaluated to meet general RF exposure requirement. The device can be used in portable exposure condition without restriction.

FCC Radiation Exposure Statement

The device has been evaluated to meet general RF exposure requirement. The device can be used in mobile (min 7.87 in.) exposure condition without restriction.

LIMITED WARRANTY

This product is warranted to be free from defects in workmanship and materials for up to one year from date of purchase. If the product fails within the warranty period, please contact Feit Electric at info@feit.com, visit feit.com/contact-us or call 1-866-326-BULB (2852) for instructions on replacement or refund. REPLACEMENT OR REFUND IS YOUR SOLE REMEDY. EXCEPT TO THE EXTENT PROHIBITED BY APPLICABLE LAW, ANY IMPLIED WARRANTIES ARE LIMITED IN DURATION TO THE DURATION OF THIS WARRANTY. LIABILITY FOR INCIDENTAL OR CONSEQUENTIAL DAMAGES IS HEREBY EXPRESSLY EXCLUDED. Some states and provinces do not allow the exclusion of incidental or consequential damages, so the above limitation or exclusion may not apply to you. This warranty gives you specific legal rights, and you may also have other rights which vary from state to state or province to province.



Only supports
2.4GHz Wi-Fi
Networks



Works with
Feit Electric app





WARNING:

This product may represent a possible shock or fire hazard if improperly installed or attached in any way. Product should be installed in accordance with the owner's manual, current electrical codes and/or the current National Electric Code (NEC).

RISK OF ELECTRIC SHOCK:
TURN OFF THE MAIN POWER AT THE CIRCUIT BREAKER BEFORE INSTALLING.

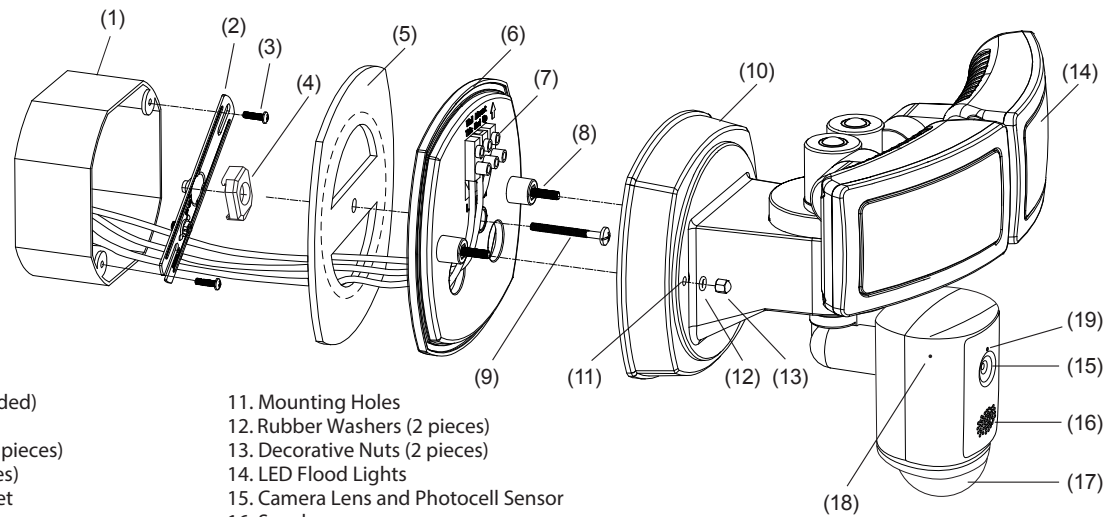

- 1. J-Box (not included)
- 2. Mounting Bar
- 3. J-Box Screws (2 pieces)
- 4. Spacers (2 pieces)
- 5. Mounting Gasket
- 6. Mounting Plate
- 7. Terminal Block
- 8. Mounting Plate Screws (2 pieces)
- 9. Mounting Bar Screw (1 piece)
- 10. Fixture Body
- 11. Mounting Holes
- 12. Rubber Washers (2 pieces)
- 13. Decorative Nuts (2 pieces)
- 14. LED Flood Lights
- 15. Camera Lens and Photocell Sensor
- 16. Speaker
- 17. Motion Sensor
- 18. Mic
- 19. Indicator Light

PARTS INCLUDED (not drawn to scale)

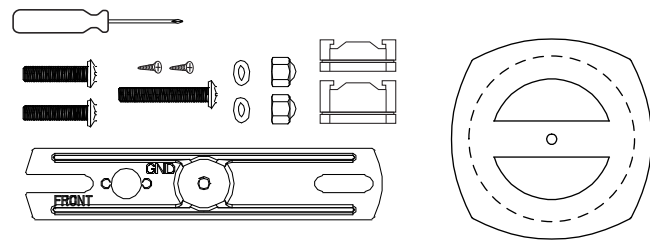

TOOLS REQUIRED (not included)

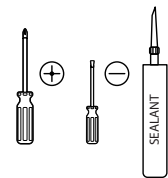

RESETTING & SD CARD

To access Reset Button and micro-SD card, remove cover using a small screwdriver (included). To reset the unit, (unit must be connected to power) press the Reset Button for 15 seconds or until you hear an audible tone. To remove micro-SD card, push card in with your finger and release. Card will eject halfway.

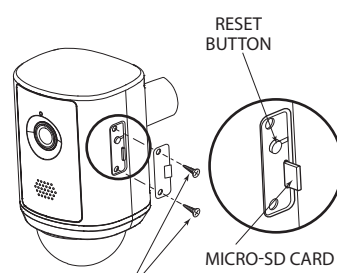

INCLUDES 2 EXTRA SCREWS

ADJUSTING FIXTURE

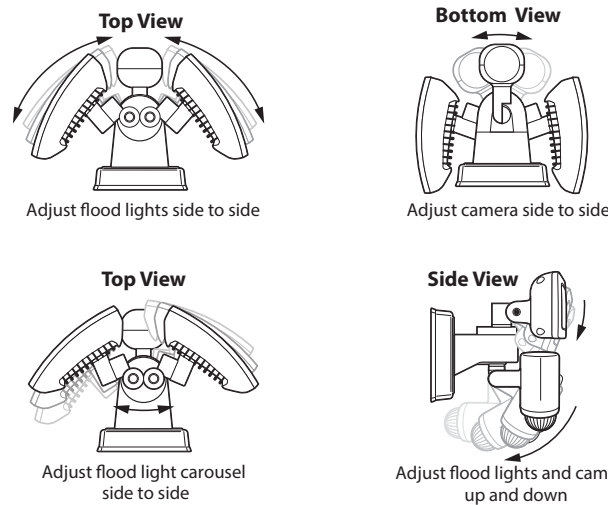

PRE-INSTALLATION

Remove the Mounting Plate (6) by unscrewing and removing the Decorative Nuts (13) and Rubber Washers (12).

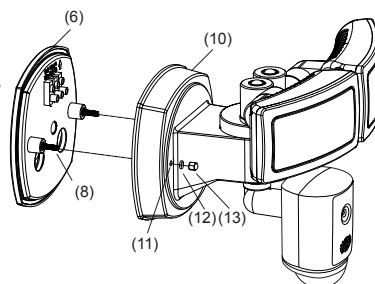

EXTERNAL J-BOX INSTALLATION

1. Turn main power Off at circuit breaker or fuse box.
2. Install Mounting Bar (2) to an External J-Box (1) using provided J-Box Screws (3). Add Spacer (4) to eliminate gap between Mounting Bar and Mounting Plate.

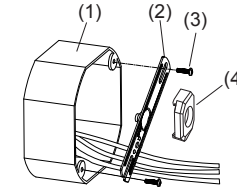

NOTE: Spacer (4) may or may not be needed.

3. Extend and feed J-Box wires through openings on Mounting Gasket (5) and Mounting Plate (6).

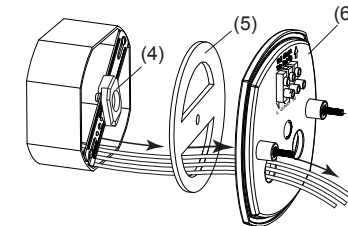

NOTE: Tear away at perforation on Mounting Gasket (5)

4. Secure Mounting Gasket (5) and Mounting Plate (6) to Mounting Bar (2) using Mounting Bar Screw (9). Do not over-tighten.

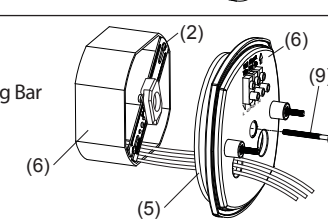

5. Connect power supply wires directly to Terminal Block (7). Secure wires to Terminal Block by using a small screwdriver. See below.

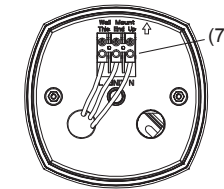

CONNECT:
Black wire to "L" input.
Ground wire to "GND" input.
White wire to "N" input.

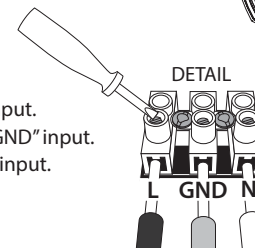

6. Position and align the Mounting Holes (11) on Fixture Body (10) to the Mounting Plate Screws (8). Secure Fixture Body (10) to Mounting Plate (6) using Rubber Washers (12) and Decorative Nuts (13).

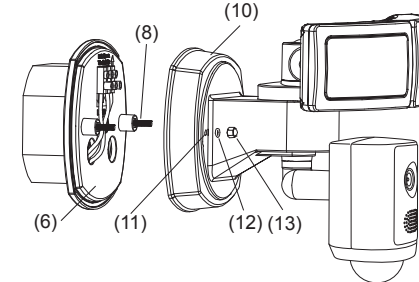

7. Turn power On at circuit breaker or fuse box. Turn On wall switch if connected to one. Ensure lights work before proceeding to step 8.
8. Once fixture is tightly secured to J-Box, apply a silicone sealant around the base of the fixture to prevent moisture from reaching the connections.

FLUSH J-BOX INSTALLATION

1. Turn main power Off at circuit breaker or fuse box.
2. Install Mounting Bar (2) to a Flush J-Box (1) using provided J-Box Screws (3). Add Spacer (4) to eliminate gap between Mounting Bar and Mounting Plate.

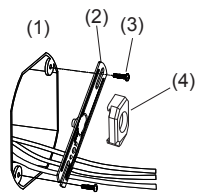

NOTE: Spacer (4) only needed if J-Box is recessed too deep.

3. Extend and feed J-Box wires through openings on Mounting Gasket (5) and Mounting Plate (6).

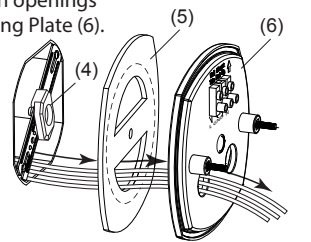

NOTE: Do not tear away at perforation on Mounting Gasket (5)

4. Secure Mounting Gasket (5) and Mounting Plate (6) to Mounting Bar (2) using Mounting Bar Screw (9). Do not over-tighten.

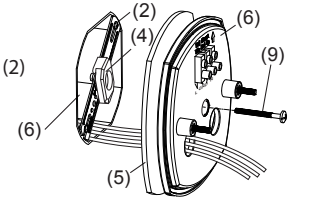

5. Connect power supply wires directly to Terminal Block (7). Secure wires to Terminal Block by using a small screwdriver. See below.

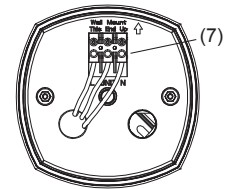

CONNECT:
Black wire to "L" input.
Ground wire to "GND" input.
White wire to "N" input.

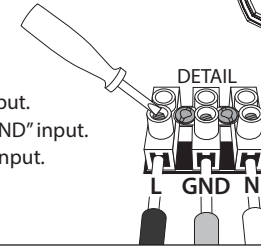

6. Position and align the Mounting Holes (11) on Fixture Body (10) to the Mounting Plate Screws (8). Secure Fixture Body (10) to Mounting Plate (6) using Rubber Washers (12) and Decorative Nuts (13).

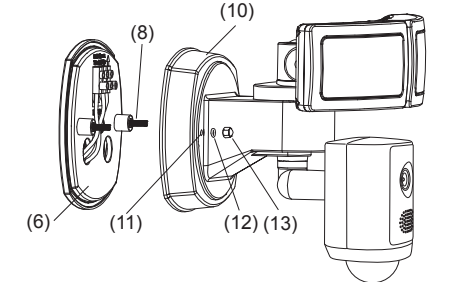

7. Turn power On at circuit breaker or fuse box. Turn On wall switch if connected to one. Ensure lights work before proceeding to step 8.
8. Once fixture is tightly secured to J-Box, apply a silicone sealant around the base of the fixture to prevent moisture from reaching the connections.