

GOCONFIGURE
Putting it all together for you

INSTALLATION SERVICES AVAILABLE!*

Need a helping hand?
Let our team of professionals handle the installation for you!

GOCONFIGURE
888-888-5424

*Installation services are only available to U.S. customers.

average 2 person assembly time



assembly time may vary based on skill level

Before you begin >>>

FOR QUICK & EASY ASSEMBLY

FIND 3D INSTRUCTIONS FOR THIS PRODUCT IN

BILT.

DOWNLOAD THE FREE APP

 GET IT ON Google Play

 Download on the App Store

For the most up to date assembly manual, to register your set, or to order replacement parts please visit www.backyarddiscovery.com

SAVE THIS ASSEMBLY MANUAL FOR FUTURE REFERENCE IN THE EVENT THAT YOU NEED TO ORDER REPLACEMENT PARTS.



GOCONFIGURE
Putting it all together for you

INSTALLATION SERVICES AVAILABLE!*

Need a helping hand?

Let our team of professionals handle the installation for you!

GOCONFIGURE
888-888-5424

**Installation services are only available
to U.S. customers.*

With Go Configure, we bring you 18 years of experience right to your doorstep. We service a wide array of indoor and outdoor recreation products that most consumers don't have the time or ability to deliver & install themselves.

We do the heavy lifting, so you don't have to!

-
- 18+ Years of Experience Servicing Big Box Retailers and Direct Consumers
 - Highly Skilled, Specialized, Courteous, Professional Service Technicians
 - Over 140,000 Installations Annually
 - White Glove Service

- Satisfaction Guarantee
- Flexible Appointments, including weekends
- Coverage across the nation

Visit www.goconfigure.com for more info!

**Installation services are only available to U.S. customers.*



The store where you made your purchase does not stock parts for this item. If you have assembly questions or you are missing or have damaged parts, please call

1-800-856-4445

you can also visit www.backyarddiscovery.com
or e-mail customerservice@backyarddiscovery.com

Please have the following information ready when you make your call:

- Model Number of the product located on the front of the assembly manual
 - The item description and number from the parts list from the manual that was included in your box
-
- Read entire assembly manual, paying special attention to the important tips and safety information.
 - To ensure there are no missing pieces do a complete inventory by first separating and identifying all parts.
 - Make sure to check packing material for small parts that may have fallen out during shipment.
 - Structures are not intended for public use. The Company does not warranty any of its residential structures subjected to commercial use.
 - This manual contains helpful information concerning assembly preparation, installation procedure and required maintenance.
 - Always keep safety in mind as your structure is being built.
 - Keep these instructions for future reference.



Please read entire booklet completely before beginning the assembly process

Please retain these instructions and your receipt for future reference. Keep them in a safe place where you can refer to them as needed. In order to provide you with the most efficient service, it is required that you provide us with the part numbers when ordering parts.

For Your Records:

Please take time and fill out the information below. This information will be needed for warranty issues.

Where Purchased: _____
 Date of Purchase: _____
 Installation Date: _____
 Installed by: _____
 Tracking Number: _____

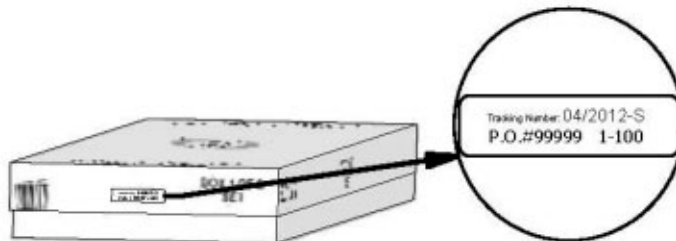

Tracking Number Reference Label

Tracking ID number on the carton and on the bottom of the vertical ID plate are included for tracking purposes associated with warranty claims.

This Limited Warranty by Backyard Discovery applies to products manufactured under the Backyard Discovery brand or its other brands including but not limited to Backyard Botanical, Adventure Playsets, and Leisure Time Products.

Backyard Discovery warrants that this product is free from defect in materials and workmanship for a period of one (1) year from the original date of purchase. This one (1) year warranty covers all parts including wood, hardware, and accessories. All wood carries a five (5) year pro-rated warranty against rot and decay. Refer to the schedule below for charges associated with replacement of parts under this Limited Warranty. In addition, Backyard Discovery will replace any parts within the first 30 days from date of purchase found to be missing from or damaged in the original packaging.

This warranty applies to the original owner and registrant and is non-transferable. Regular maintenance is required to assure maximum life and performance of this product. Failure by the owner to maintain the product according to the maintenance requirements may void this warranty. Maintenance guidelines are provided in the Owner's Manual.

This Limited Warranty does not cover:

- Labor for any inspection
- Labor for replacement of any defective item(s)
- Incidental or consequential damages
- Cosmetic defects which do not affect performance or integrity of a part or the entire product
- Vandalism, improper use, failure due to loading or use beyond the capacities stated in the applicable Assembly Manual.
- Acts of nature including but not limited to wind, storms, hail, floods, excessive water exposure
- Improper installation including but not limited to installation on uneven, unlevel, or soft ground
- Minor twisting, warping, checking, or any other natural occurring properties of wood that do not affect performance or integrity

Backyard Discovery products have been designed for safety and quality. Any modifications made to the original product could damage the structural integrity of the unit leading to failure and possible injury. Modification voids any and all warranties and Backyard Discovery assumes no liability for any modified products or consequences resulting from failure of a modified product.

This product is warranted for RESIDENTIAL USE ONLY. Under no circumstance should a Backyard Discovery product be used in public settings. Such use may lead to product failure and potential injury. Any and all public use will void this warranty. Backyard Discovery disclaims all other representations and warranties of any kind, express or implied.

Pro Rated Part Replacement Schedule

<u>Product Age</u>	<u>Customer Pays</u>
All Parts	
0-30 days from date of purchase	\$0 and free shipping
31 days to 1 year	\$0 + S&H
Wood Rot and Decay Only	
1 year	\$0 and free shipping
2 year	20% + S&H
3 year	40% + S&H
4 year	60% + S&H
5 year	80% + S&H
Over 5 years	100% + S&H



WARNING

IT IS IMPORTANT TO CHECK AND TIGHTEN ALL HARDWARE AT THE BEGINNING AND DURING THE SEASON AS THEY MAY LOOSEN DUE TO WOOD EXPANSION AND CONTRACTION.

- **DO NOT climb or walk on the roof for any reason**
- **Requires two or more people to assemble safely**
- **Check for underground utilities before digging or driving stakes into the ground.**
- **Check carefully for overhead lines and ensure there is at least 6ft (2m) clearance from any overhead electrical wires.**
- **Permanent structures may require a building permit. As the purchaser and or installer of this product you are advised to consult local planning, zoning and building inspection departments for guidance on applicable building codes and/or zoning requirements.**
- Wood is NOT flame retardant and will burn. Grills, fire pits and chimineas are a fire hazard if place too close to your structure.
- Wear gloves to avoid injury during installation.
- During installation, follow all safety warnings provided with your tools and use safety glasses.
- Check all nuts and bolts twice monthly during the usage season and tighten as required.(But not so tight that you crack the wood) It is particularly important that this procedure be followed at the beginning of each season.
- Oil all metallic moving parts monthly during the usage period.
- Check all coverings for bolts and sharp edges twice monthly during usage season to be certain they are in place. Replace when necessary. It is especially important to do this at the beginning of each new season.
- For rusted areas on metallic members such as hinges, brackets, etc. sand and repaint, using a non lead-based paint meeting the requirements of Title 16 CRF Part 1303.
- Inspect wood parts monthly. The grain of the wood sometimes will lift in the dry season causing splinters to appear. Light sanding may be necessary to maintain a safe environment. Treating your Product with protection (sealant) after sanding will help prevent severe checking/splitting and other weather damage.
- We have applied a waterborne translucent stain to your unit. This is done for color only. Once or twice a year, depending on your climate conditions, you must apply some type of protection (sealant) to the wood of your unit. Prior to the application of sealant, lightly sand any "rough" spots on your set. Please note this is a requirement of your warranty.

OWNERS SHALL BE RESPONSIBLE FOR MAINTAINING THE LEGIBILITY OF THE WARNING LABELS



Your Backyard Discovery structure is designed and constructed of quality materials. As with all outdoor products it will weather and wear. To maximize the enjoyment, safety and life of your structure it is important that you properly maintain it.

About Our Wood

Backyard Discovery uses 100% Cedar (C. Lanceolata) wood. Although we take great care in selecting the best quality lumber available, wood is still a product of nature and susceptible to weathering which can change the appearance of your set.

What causes weathering? Does it affect the strength of my product?

One of the main reasons for weathering is the effects of water (moisture); the moisture content of the wood at the surface is different than the interior of the wood. As the climate changes, moisture moves in or out of the wood, causing tension which can result in checking and or warping. You can expect the following due to weathering. These changes will not affect the strength of the product:

1. Checking is surface cracks in the wood along the grain. A post (4" x 4") will experience more checking than a board (1" x 4") because the surface and interior moisture content will vary more widely than in thinner wood.

2. Warping results from any distortion (twisting, cupping) from the original plane of the board and often happens from rapid wetting and drying of the wood.

3. Fading happens as a natural change in the wood color as it is exposed to sun-light and will turn grey over time.

How can I reduce the amount of weathering to wood product?

1. Your wood product is coated with a water-based stain. Sunlight will break down the coating, so we recommend applying a water repellent or stain on a yearly basis (see your local stain and paint supplier for a recommended product). You must apply some type of protection (sealant) to the wood of your product. **Please note this is a requirement of your warranty.** Most weathering is just the normal result of nature and will not affect safety. However if you are concerned that a part has experienced a severe weathering problem please call our customer service department for further assistance.

2. Inspect wood parts monthly. The grain of the wood sometimes will lift in the dry season causing splinters to appear. Light sanding may be necessary to maintain a safe environment. Treating your Product with protection (sealant) after sanding will help prevent severe checking/ splitting and other weather damage.



Protrusion Hazard

Incorrect

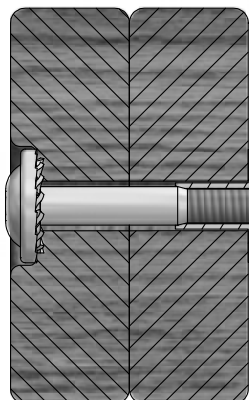

If you see exposed threads and your bolt protrudes beyond the T-Nut you may have over tightened the bolt or used incorrect hardware. If you've overtightened, remove the bolt and add washers to eliminate the protrusion.

Correct

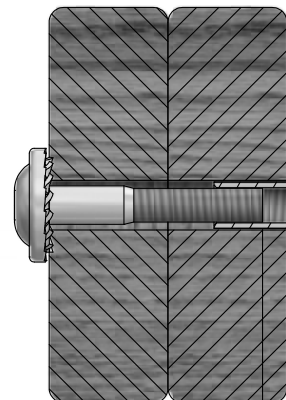

1/8"

Proper Hardware Assembly

Bolt and T-Nut Assembly

Tap T-nut into the provided hole. Insert your bolt through the lock washer and insert into the provided hole opposite from the T-Nut. Turn clockwise to thread into T-nut. Do not completely tighten until instructed.

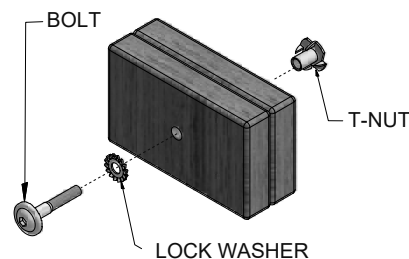

Bolt and Barrel Nut Assembly

Insert barrel nut through the lock washer and press the pair through the provided hole. Insert your bolt through the second lock washer and insert the pair into the provided hole opposite from the barrel nut. Turn clockwise to thread into the barrel nut. Do not completely tighten until instructed.

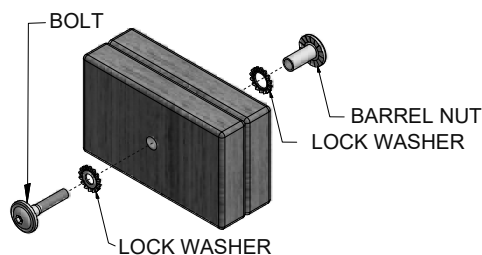

Lag Assembly

Normally there will be a pre-drilled pilot hole on assemblies that require a Lag Screw. If there is no pilot hole, line up the two boards as they are to be attached and use the factory drilled hole as a guide to drill another pilot hole into the adjoining board. This will keep the wood from splitting. Only a lock washer is required for steps with Lag Screws.

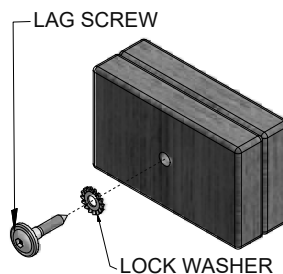



ASSEMBLY TIP:

Keep an eye out for these boxes which will contain helpful pictures and information making the assembly process as quick and painless as possible.

Sorting Wood

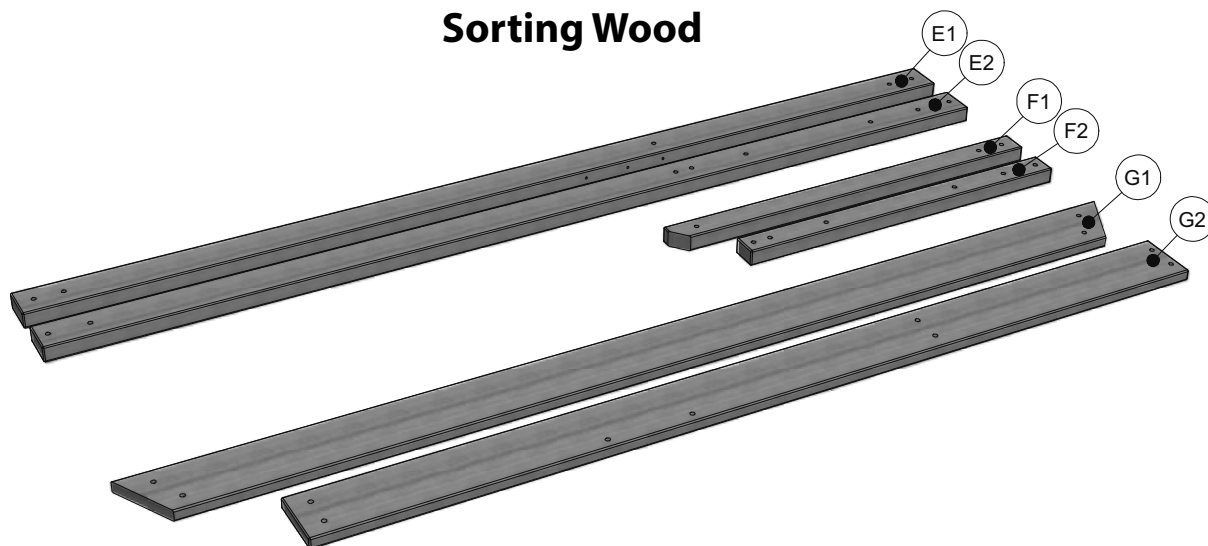

When removing the wood from the boxes we recommend arranging them by part number before you begin assembly. This will allow for faster assembly and easily identify any parts that may be missing or damaged.

Sorting Hardware

NUT BARREL
H100545



SCREW
H100695



T-NUT
H100699

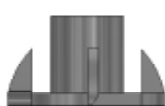

WASHER FLAT
H100706



BOLT HEX
H100716



BOLT
H100718



SCREW PWH
H100742

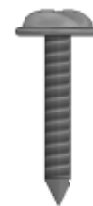

To help with assembly we recommend sorting your hardware bags with the seven digit alpha-numeric number printed on the bags or by hardware type (i.e. bolts, nuts, etc.). Organizing your hardware will make assembly easier.

Hardware Identification

Hardware bags are printed with a seven digit alpha-numeric part number. During assembly you only need to reference the last three digits of the part number as noted in each step. This will make finding the correct hardware easier.

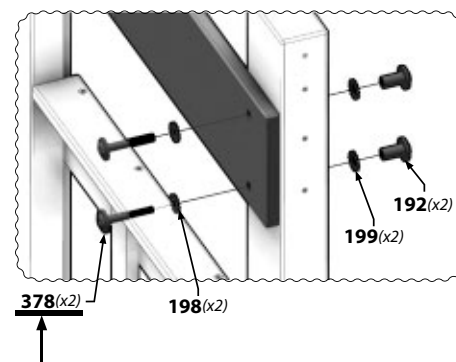
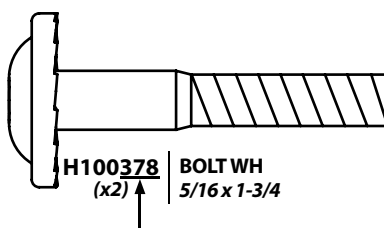

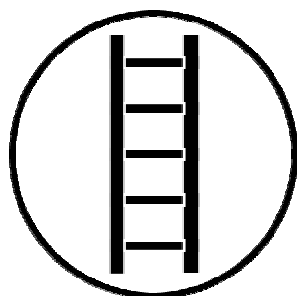
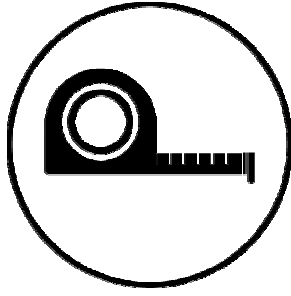
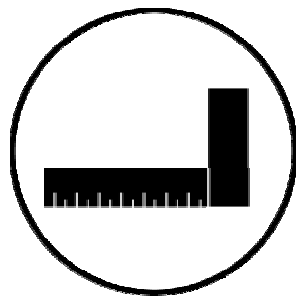
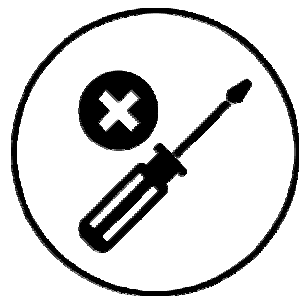
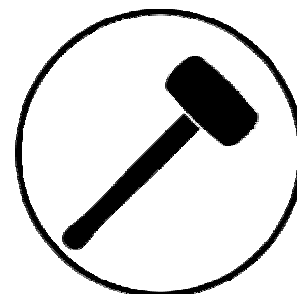
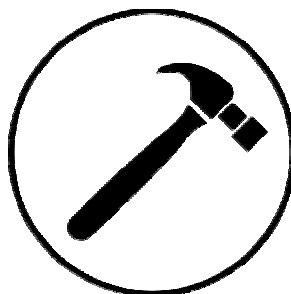
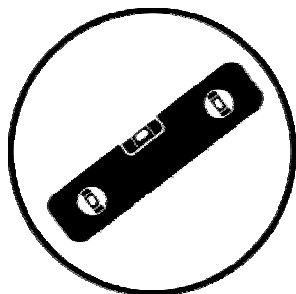
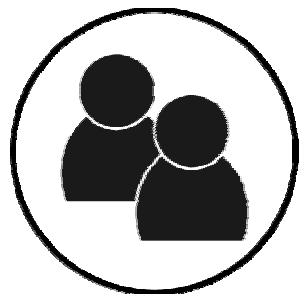

(2 NEEDED)

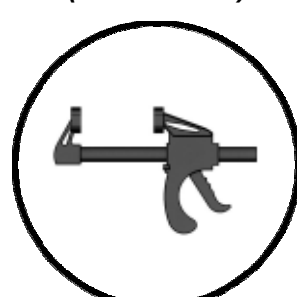
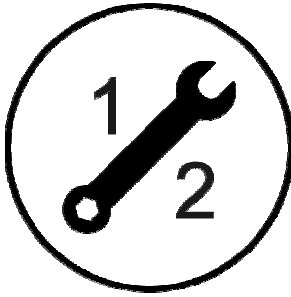
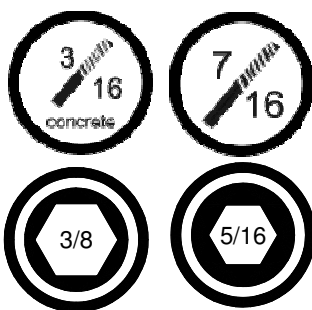
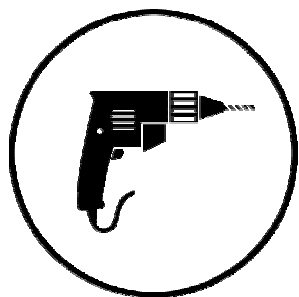

Icons and their uses you will see throughout this manual



You will need to make sure that your assembly is square before tightening your bolts.



When you see this icon you will need a socket wrench. The icons below show the size of attachments needed for assembly 1/2.



For proper assembly you will need to ensure that your structure is level before proceeding to the next step.

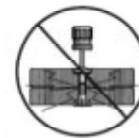

This icon warns you to not over tighten your bolts. This is to prevent structural damage and also splintering your wood.



Some steps in the assembly process will require an extra set of hands. Make sure you have a helper available.



A ladder will be needed for assembly. Do NOT stand on the set when it is incomplete, unstable, and not anchored. Failure to do so may result in injury.



This icon shows the size of an open ended wrench. Using the wrench as the fraction bar.



This icon will show you what drill attachments are needed. For this example you will need a Phillips head attachment and 3/8 drill bit.



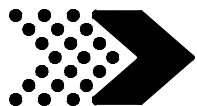

It is critically important that you start with square and level footings, concrete pad or deck to attach your structure

- Pay close attention to the items needed for each step. Make sure you are using the correct hardware for each step. Using incorrect hardware may result in improper assembly
- Remember to double check for underground utilities and overhead electrical lines

Post mounts are provided with your structure which allows you to permanently install your structure to a pre-existing or new wood or concrete surface.

- The hardware to attach the post mounts to the structure is included.
- The hardware to mount the structure permanently to a concrete surface is included.
- The hardware to mount the structure permanently to a wood deck is NOT included and will need to be purchased separately. **You must ensure there is ample structural support under the deck before permanently attaching.**

Metal Roof Assembly

Remove plastic covering from metal roof panels before installing each piece. Place roofing materials on a nonabrasive, flat surface before and after assembly as it could bend, dent or scratch

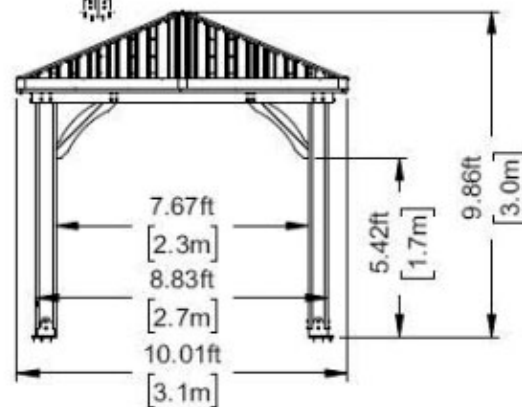
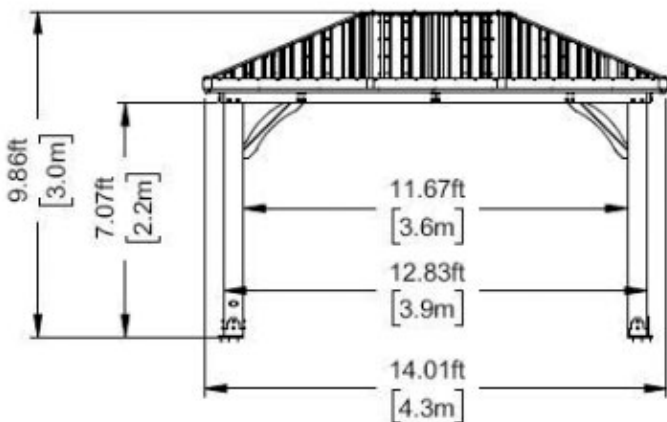
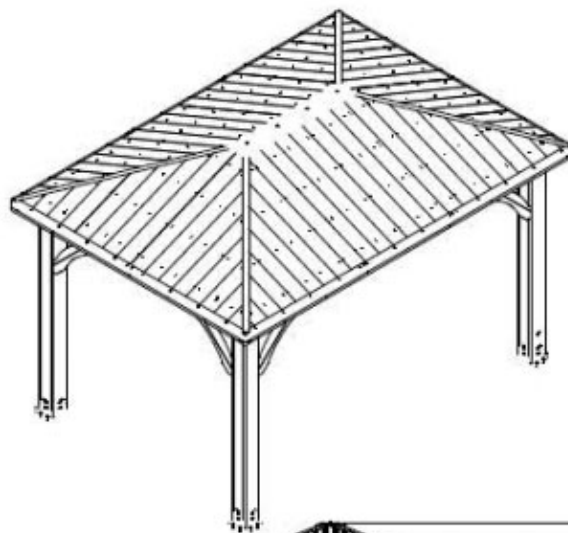
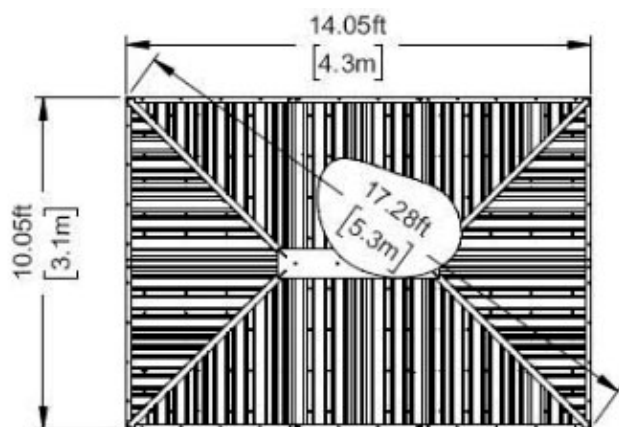

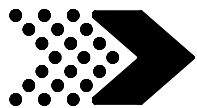

Wood Components (Not to Scale)



H01 | ROOF JOIST- W4L14429
(2) | 1"x3 3/8"x88 1/8" (24x86x2240)



H02 | ROOF JOIST- W4L14430
(2) | 1"x3 3/8"x46 3/4" (24x86x1188)

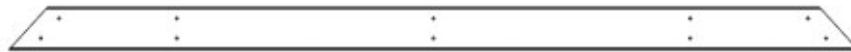

H03 | PURLIN - W4L14420
(2) | 1"x3 3/8"x68 3/8" (24x86x1736)

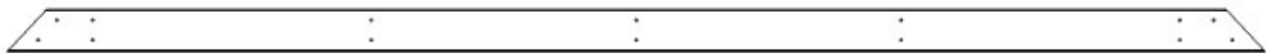

H04 | PURLIN - W4L14422
(2) | 1"x3 3/8"x98 3/16" (24x86x2494)



H05 | PURLIN - W4L14423
(2) | 1"x3 3/8"x64 11/16" (24x86x1644)



H06 | PURLIN - W4L14424
(2) | 1"x3 3/8"x64 11/16" (24x86x1644)



H07 | PURLIN - W4L14425
(4) | 1"x3 3/8"x58 15/16" (24x86x1497)



H08 | PURLIN - W4L14426
(2) | 1"x3 3/8"x42 3/4" (24x86x1086)

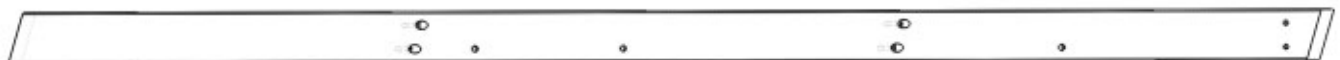

H09 | ROOF JOIST- W4L14428
(2) | 1"x3 3/8"x88 3/16" (24x86x2240)

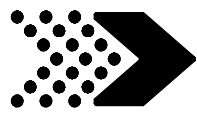

Wood Components (Not to Scale)



H10 | ROOF JOIST- W4L14437
(2) | 1"x3 3/8"x76 13/16" (24x86x1952)

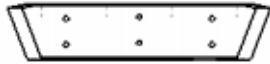

H11 | ROOF JOIST- W4L14438
(2) | 1"x3 3/8"x15 15/16" (24x86x404)



H13 | PURLIN - W4L14446
(2) | 1"x3 3/8"x20 1/4" (24x86x514)

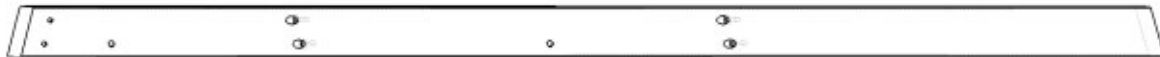

H12 | ROOF JOIST- W4L14440
(2) | 1"x3 3/8"x76 13/16" (24x86x1952)



H14 | PURLIN - W4L14447
(2) | 1"x3 3/8"x50 1/16" (24x86x1272)

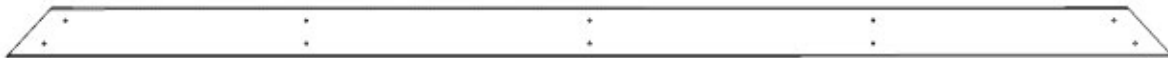

H15 | PURLIN - W4L14448
(2) | 1"x3 3/8"x79 7/8" (24x86x2030)

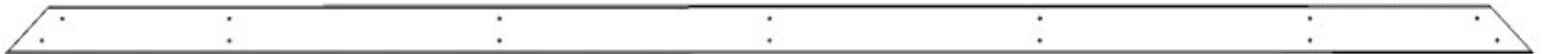

H16 | PURLIN - W4L14449
(2) | 1"x3 3/8"x109 3/4" (24x86x2787)



H17 | PURLIN - W4L14525
(2) | 1"x1 3/8"x51 3/8" (24x34x1306)



H18 | ROOF SUPPORT- W4L14526
(1) | 1"x3 3/8"x48" (24x86x1219)



H19 | ROOF SUPPORT- W4L14527
(4) | 1"x3 3/8"x74 7/8" (24x86x1902)

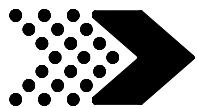

Wood Components (Not to Scale)



E01 | RAFTER- W4L14431
(2) 1 3/8"x3 3/8"x44" (36x86x1117)



E02 | RAFTER- W4L14434
(4) 1 3/8"x3 3/8"x63 7/8" (36x86x1622)



E03 | RAFTER- W4L14432
(2) 1 3/8"x3 3/8"x20 7/16" (36x86x519)



E06 | RAFTER - W4L14524
(2) 1 3/8"x3 3/8"x20 7/16" (36x86x519)



E04 | RAFTER- W4L14523
(2) 1 3/8"x3 3/8"x44" (36x86x1117)



E05 | RAFTER - W4L14442
(2) 1 3/8"x3 3/8"x42 3/4" (36x86x1087)



E07 | RAFTER- W4L14444
(2) 1 3/8"x3 3/8"x42 7/8" (36x86x1087)



E08 | RAFTER - W4L14445
(2) 1 3/8"x3 3/8"x21 3/4" (36x86x553)



E10 | RAFTER- W4L14443
(2) 1 3/8"x3 3/8"x21 3/4" (36x86x553)

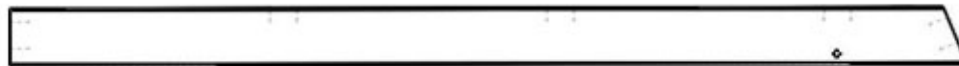

E09 | RAFTER- W4L14439
(2) 1 3/8"x3 3/8"x55 13/16" (36x86x1417)



E11 | RAFTER W4L14528
(2) 1 3/8"x3 3/8"x55 13/16" (36x86x1622)

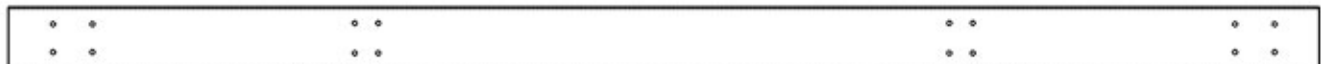

D01 | BEAM- W4L14521
(2) 1 3/8"x5 1/4"x109 13/16" (36x134x2789)

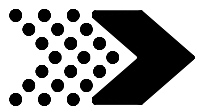

Wood Components (Not to Scale)



C01 | CORBEL - W2A03123
(8) | 1 3/8"x6 7/16"x36 15/16" (36x163x938)



G01 | BEAM - W4L14450
(4) | 1"x5 1/4"x28 1/8" (24x134x714)



G02 | MID BRACE BEAM - W4L14451
(2) | 1"x5 1/4"x97 13/16" (24x134x2484)



G03 | BEAM - W4L14452
(4) | 1"x5 1/4"x77" (24x134x1956)



Q01 | ROOF JOIST - W4L14435
(4) | 1"x4 7/16"x83 3/4" (24x112x2128)



Q02 | ROOF JOIST - W4L14436
(4) | 1"x4 7/16"x60 11/16" (24x112x1542)

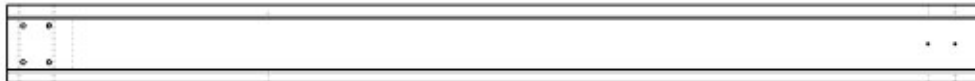

P01 | POST - W2A03124
(2) | 7"x7"x89 1/2" (178x178x2274)

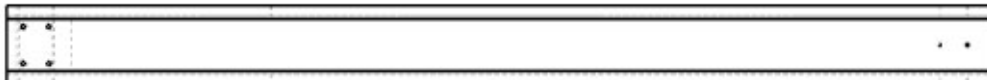

P02 | POST - W2A03125
(2) | 7"x7"x89 1/2" (178x178x2274)



Hardware Components



H100792 | LAG SCREW WH BLK
(13) | 1/4x3



H100171 | BOLT WH BLK
(34) | 1/4x1



H100460 | LAG SCREW
(9) | WH BLK
1/4x1



H100488 | BOLT WH BLK
(15) | 1/4x2



H100379 | T-NUT BLK
(7) | 5/16



H100398 | T-NUT BLK
(34) | 1/4



H100407 | BOLT WH BLK
(9) | 5/16x1-1/2



H100192 | NUT BARREL
(34) | WH BLK
5/16x7/8

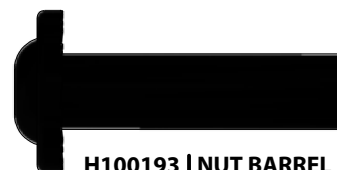

H100193 | NUT BARREL
(34) | WH BLK
5/16x1-1/2



H100378 | BOLT WH BLK
(7) | 5/16x1-3/4



H100471 | LAG SCREW
(34) | WH BLK
5/16x1 1/2



H100469 | NUT BARREL
(9) | WH BLK
5/16x5/8



H100205 | BOLT WH BLK
(x18) | 5/16x2-1/4



H100195 | BOLT WH BLK
(18) | 5/16x2 3/4



H100415 | BOLT WH BLK
(18) | 5/16x3-3/4



H100963 | BOLT WH BLK
(18) | 5/16x7-3/4



H100765 | BOLT WH BLK
(18) | 5/16x8

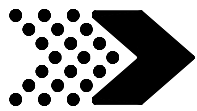

Hardware Components



H100385 | SCREW PFH BLK
(39) | 8x1



H100200 | SCREW PFH BLK
(28) | 8x1 1/2



H100382 | SCREW PFH BLK
(17) | 8x1 3/4



H100759 | SCREW TAPPING
(64) | 1/4x3/4



H100392 | SCREW PWH BLK
(48) | 8x3/4

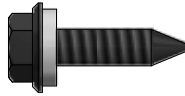

H100833 | SCREW WOODGRIP
(224) | 10x3/4



H101030 | SCREW CONFIRMAT BLK
(98) | 7x2



H100391 | SCREW PFH BLK
(192) | 8x2



H100770 | WASHER FLAT
(x17) | BLK 5/16



H101034 | WEATHER PROOF
(x4) | WASHER



H100479 | NUT LOCK BLK
(x18) | 5/16



H100199 | WASHER LOCK
(76) | EXT BLK 12x19



H100198 | WASHER LOCK
(98) | EXT BLK 8x19



H100630 | WASHER FLAT
(33) | BLK 8x19



H100405 | WASHER LOCK
(9) | EXT BLK 6x15



H100653 | NUT LOCK BLK
(x15) | 1/4



H100120 | SCREW CONCRETE ANCHOR
(18) | 1/4x2



H100764 | SCREW SETTER
(1)

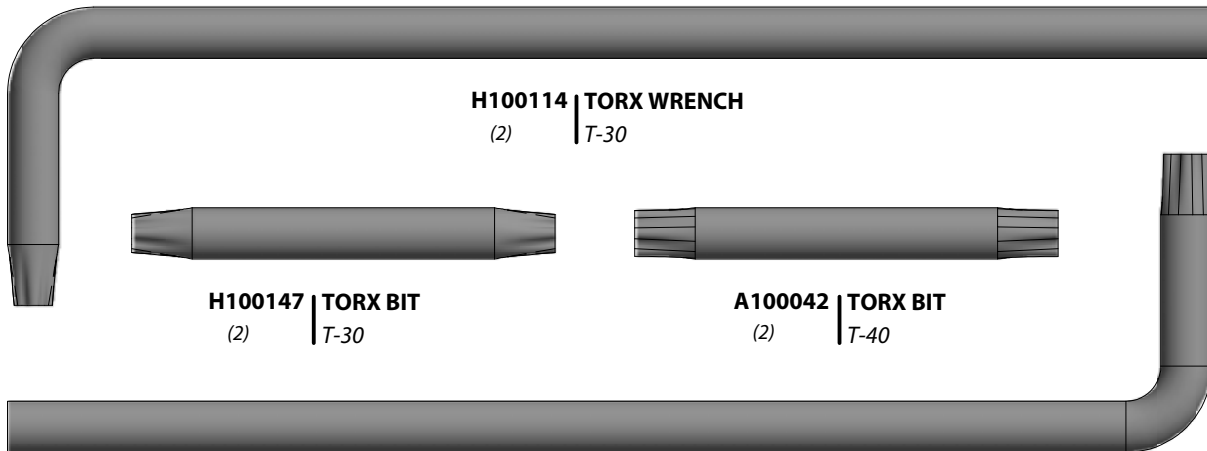

H100114 | TORX WRENCH
(2) | T-30

H100147 | TORX BIT
(2) | T-30

A100042 | TORX BIT
(2) | T-40

A100041 | TORX WRENCH
(2) | T-40



Accessory Components (Not to Scale)

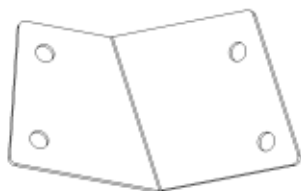

A4M01191 | PANEL BRACKET
(2)

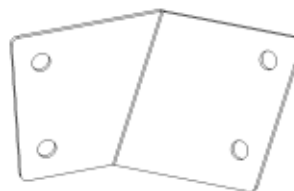

A4M01192 | PANEL BRACKET
(2)

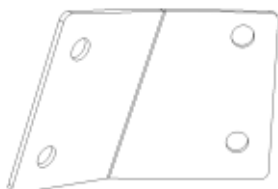

A4M01194 | PANEL BRACKET
(2)



A4M01193 | PANEL BRACKET
(2)

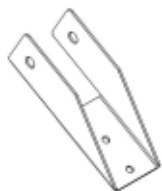

A4M01228 | RAFTER CLIP
(14)

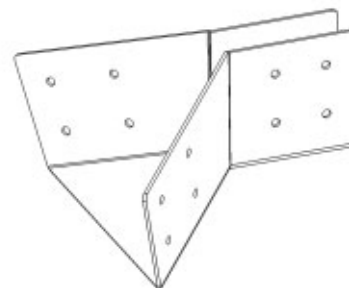

A4M01184 | PANEL SUPPORT BRACKET
(2)

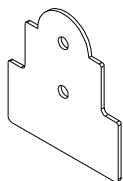

A4M00950 | STEEL POST PLATE
(8)

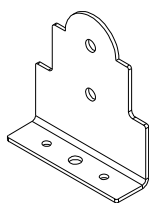

A4M00949 | STEEL POST ANCHORING PLATE WITH FLANGE
(8)

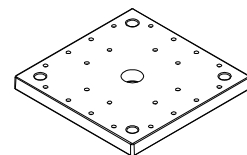

A6P00296 | 7x7 POST FOOT
(4)



A100241 | BYD ID TAG (SMALL) WITHOUT AGES
(1)



A4M01185 | CORNER BRACKET
(4)

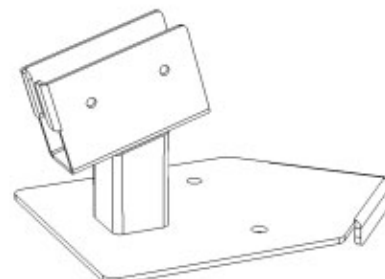

A4M01178 | POST CLIP
(4)

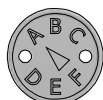

A100314 | "A" REVISION TAG
(1)

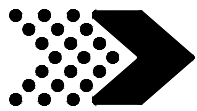

Accessory Components (Not to Scale)



A4M01200 | EDGE TRIM LONG
(8)



A4M01203 | EDGE TRIM SHORT
(2)

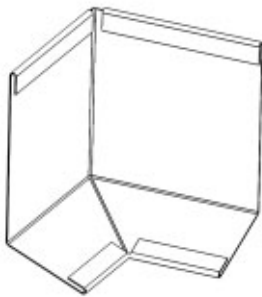

A4M01202 | EDGE TRIM CORNER SPLICE
(4)



A4M01205 | METAL SPACER
(4)

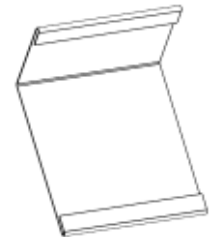

A4M01201 | EDGE TRIM SPLICE
(6)

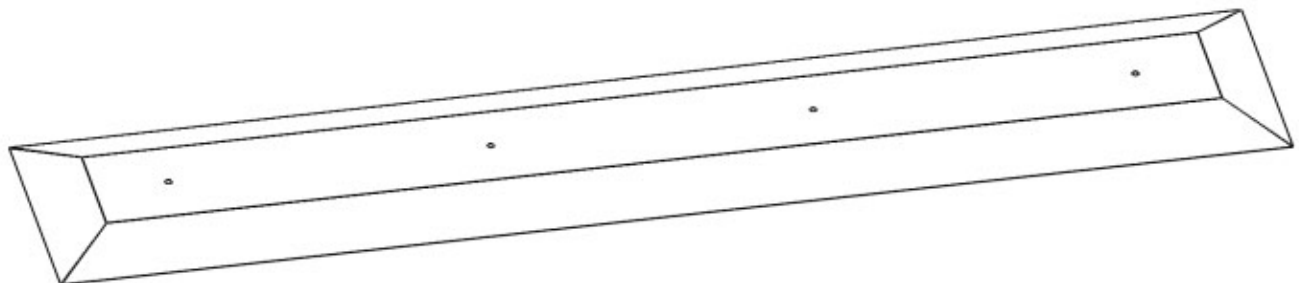

A4M01204 | RIDGE PEAK CAP
(1)

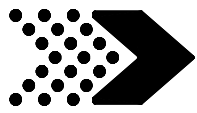

Accessory Components (Not to Scale)

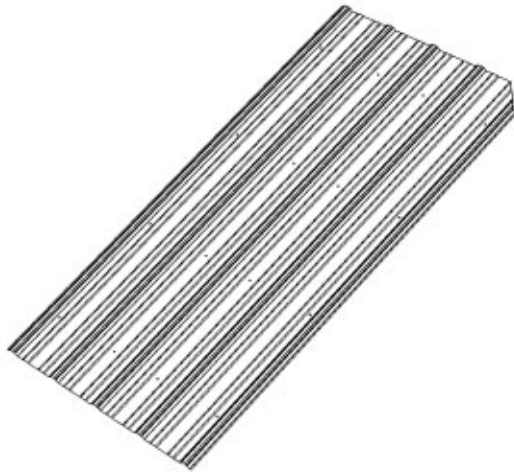

A4M01175 | 29 GA STEEL SHEETING
(2)

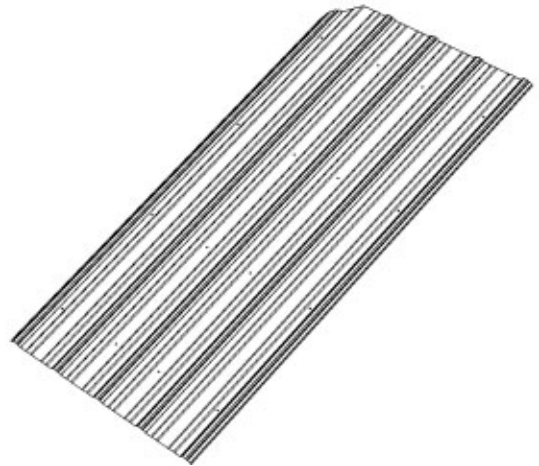

A4M01179 | 29 GA STEEL SHEETING
(2)

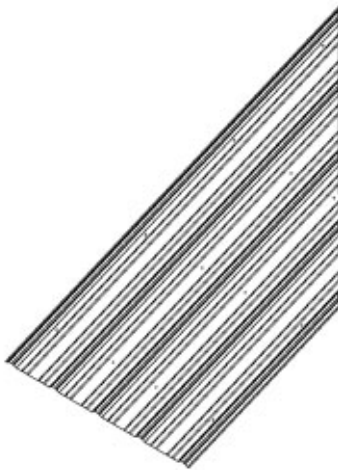

A4M01176-1 | 29 GA STEEL SHEETING
(2)

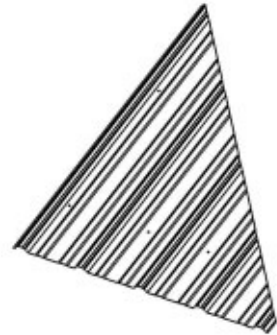

A4M01176-2 | 29 GA STEEL SHEETING
(2)

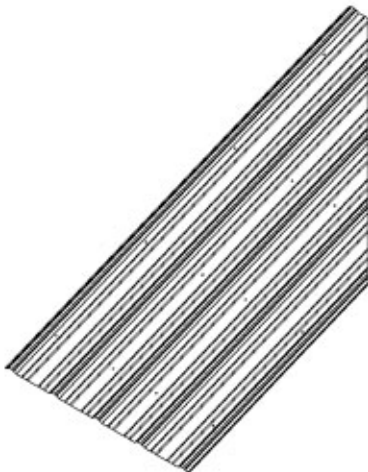

A4M01177-2 | 29 GA STEEL SHEETING
(2)

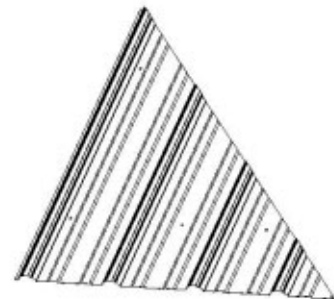

A4M01177-1 | 29 GA STEEL SHEETING
(2)

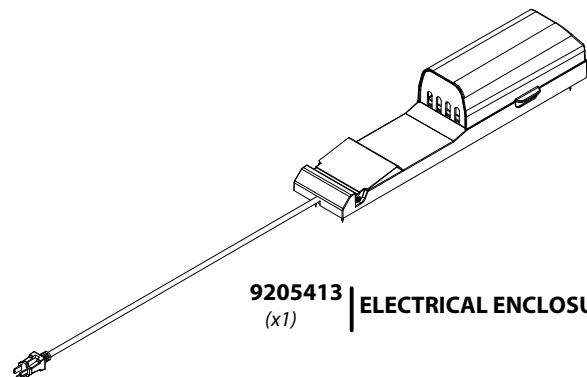

9205413 | ELECTRICAL ENCLOSURE
(x1)

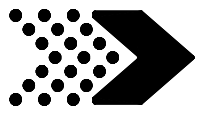

Accessory Components (Not to Scale)

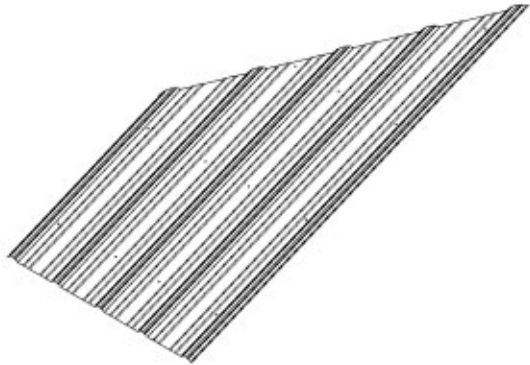

A4M01180-1 | 29 GA STEEL SHEETING
(2)

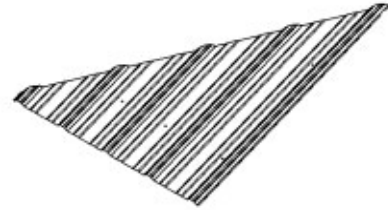

A4M01180-2 | 29 GA STEEL SHEETING
(2)

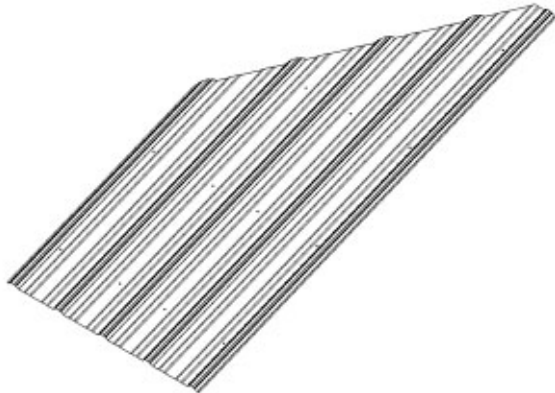

A4M01181-2 | 29 GA STEEL SHEETING
(2)



A4M01181-1 | 29 GA STEEL SHEETING
(2)

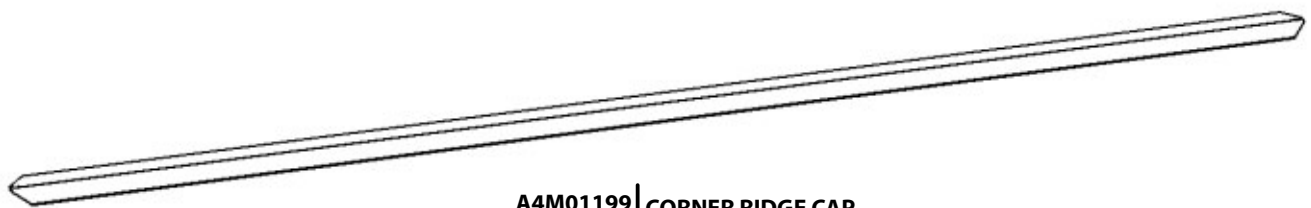

A4M01199 | CORNER RIDGE CAP
(4)

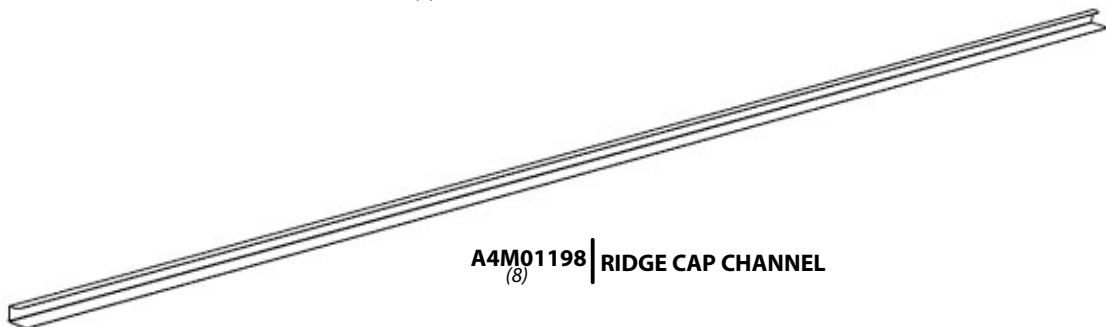

A4M01198 | RIDGE CAP CHANNEL
(8)

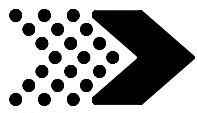

P01 | POST - W2A03124
(2) | 7"x7"x89 1/2" (178x178x2274)

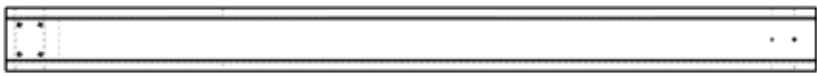

P02 | POST - W2A03125
(2) | 7"x7"x89 1/2" (178x178x2274)

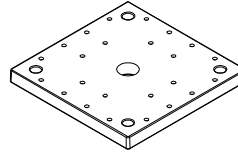

A6P00296 | 7x7 POST FOOT
(4)



H100200 | SCREW PFH BLK
(16) | 8x1 1/2

COMPLETE THIS STEP TWICE



TIP:

FOR EASE OF ASSEMBLY WE RECOMMEND USING SAW HORSES FOR STEPS 1 THRU 6.

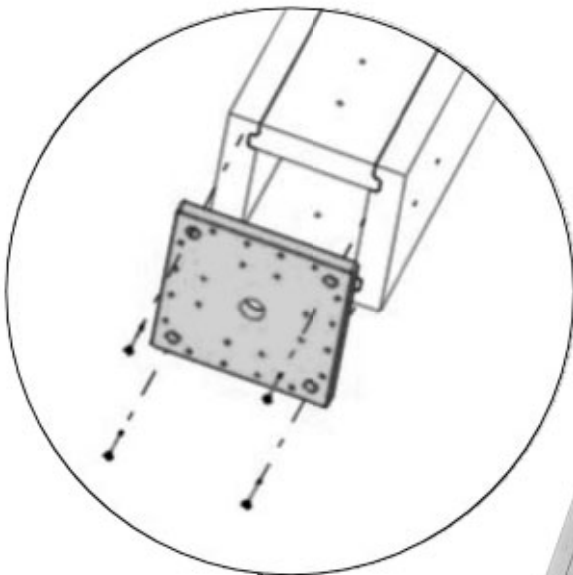

200 (x8)
SCREW - 1 1/2"

P02 (x1)
POST

P01 (x1)
POST

296 (x2)
7x7 POST FOOT



D01 | **BEAM- W4L14521**
 (2) 1 3/8"x5 1/4"x109 13/16" (36x134x2789)



H100963 | **BOLT WH BLK**
 (16) 5/16x7-3/4

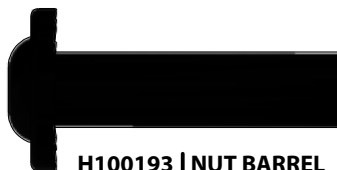

H100193 | **NUT BARREL**
 (16) WH BLK
 5/16x1-1/2



H100199 | **WASHER LOCK**
 (16) EXT BLK
 12x19



H100198 | **WASHER LOCK**
 (16) EXT BLK
 8x19

COMPLETE THIS STEP TWICE

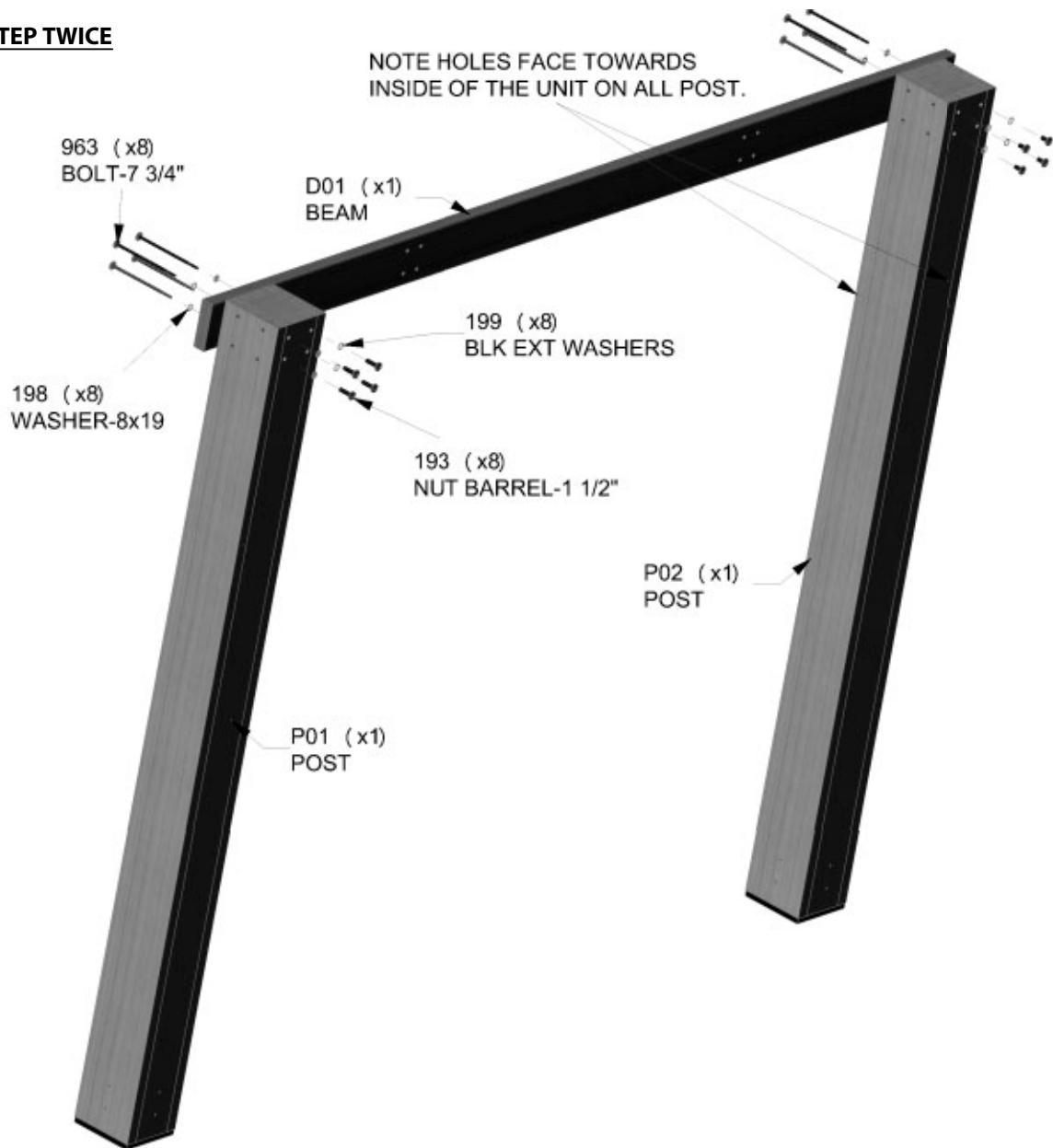

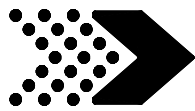

GAZEBO ASSEMBLY

STEP 3



C01 | CORBEL- W2A03123
(4) | 1 3/8"x6 7/16"x36 15/16" (36x163x938)



H100205 | BOLT WH BLK
(16) | 5/16x2 1/4

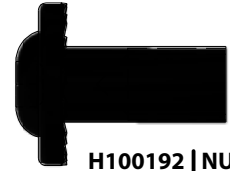

H100192 | NUT BARREL WH BLK
(16) | 5/16x7/8



H100792 | LAG SCREW WH BLK
(4) | 1/4x3



H100405 | WASHER LOCK EXT BLK 6x15
(4)

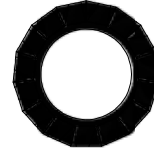

H100199 | WASHER LOCK EXT BLK 12x19
(16)



H100198 | WASHER LOCK EXT BLK 8x19
(16)

COMPLETE THIS STEP TWICE

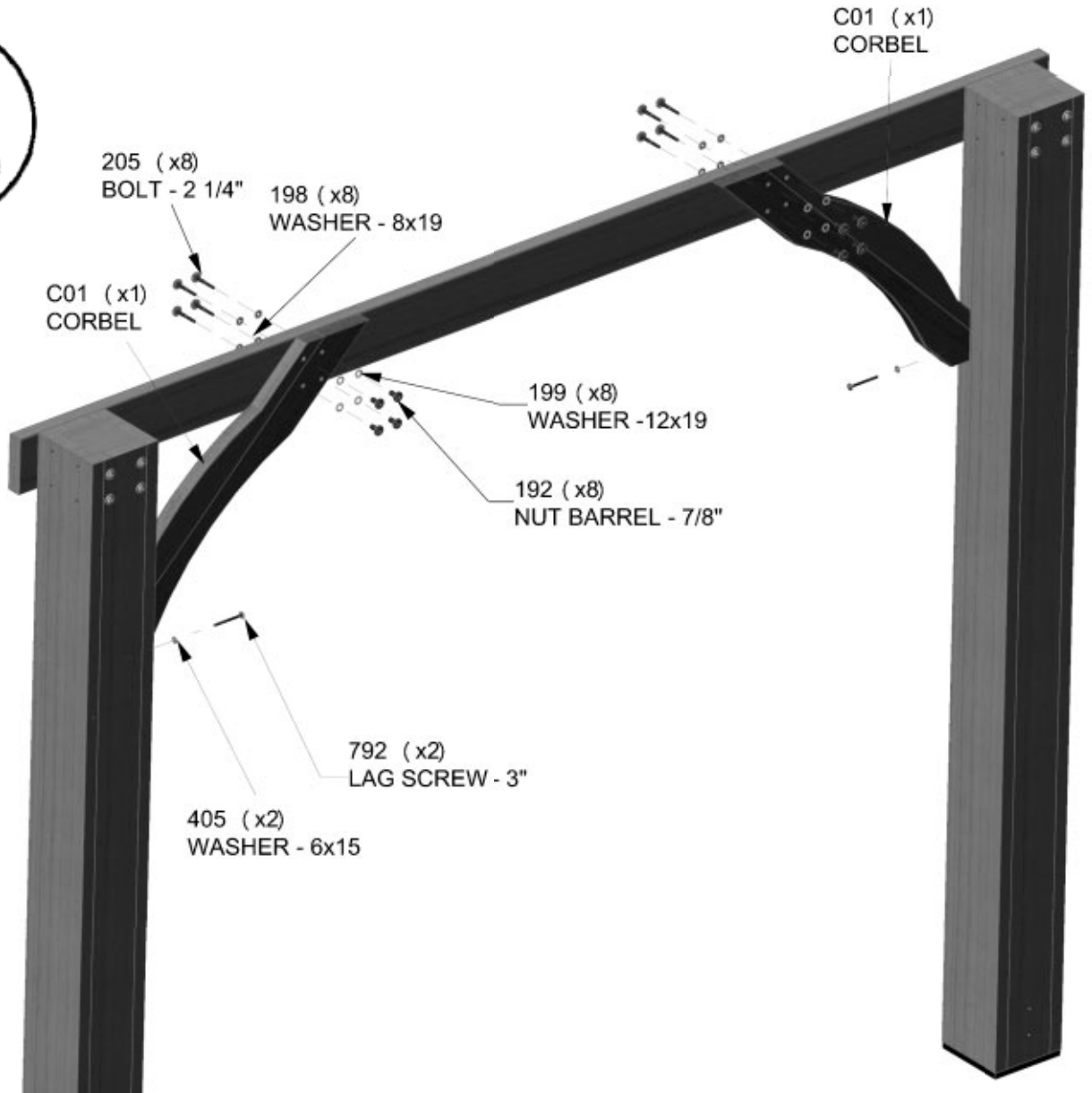



C01 | CORBEL - W2A03123
(4) | 1 3/8"x6 7/16"x36 15/16" (36x163x938)



G03 | BEAM - W4L14452
(4) | 1"x5 1/4"x77" (24x134x1956)



G02 | BEAM - W4L14451
(2) | 1"x5 1/4"x97 13/16" (24x134x2484)



G01 | BEAM - W4L14450
(4) | 1"x5 1/4"x28 1/8" (24x134x714)



H100407 | BOLT WH BLK
(8) | 5/16x1 1/2



**H100199 | WASHER LOCK
EXT BLK**
(24) | 12x19



**H100198 | WASHER LOCK
EXT BLK**
(24) | 8x19



**H100192 | NUT BARREL
WH BLK 5/16x7/8**
(16)



H100195 | BOLT WH BLK
(16) | 5/16x2-3/4



H100469 | NUT BARREL WH BLK
(8) | 5/16x5/8

COMPLETE THIS STEP TWICE

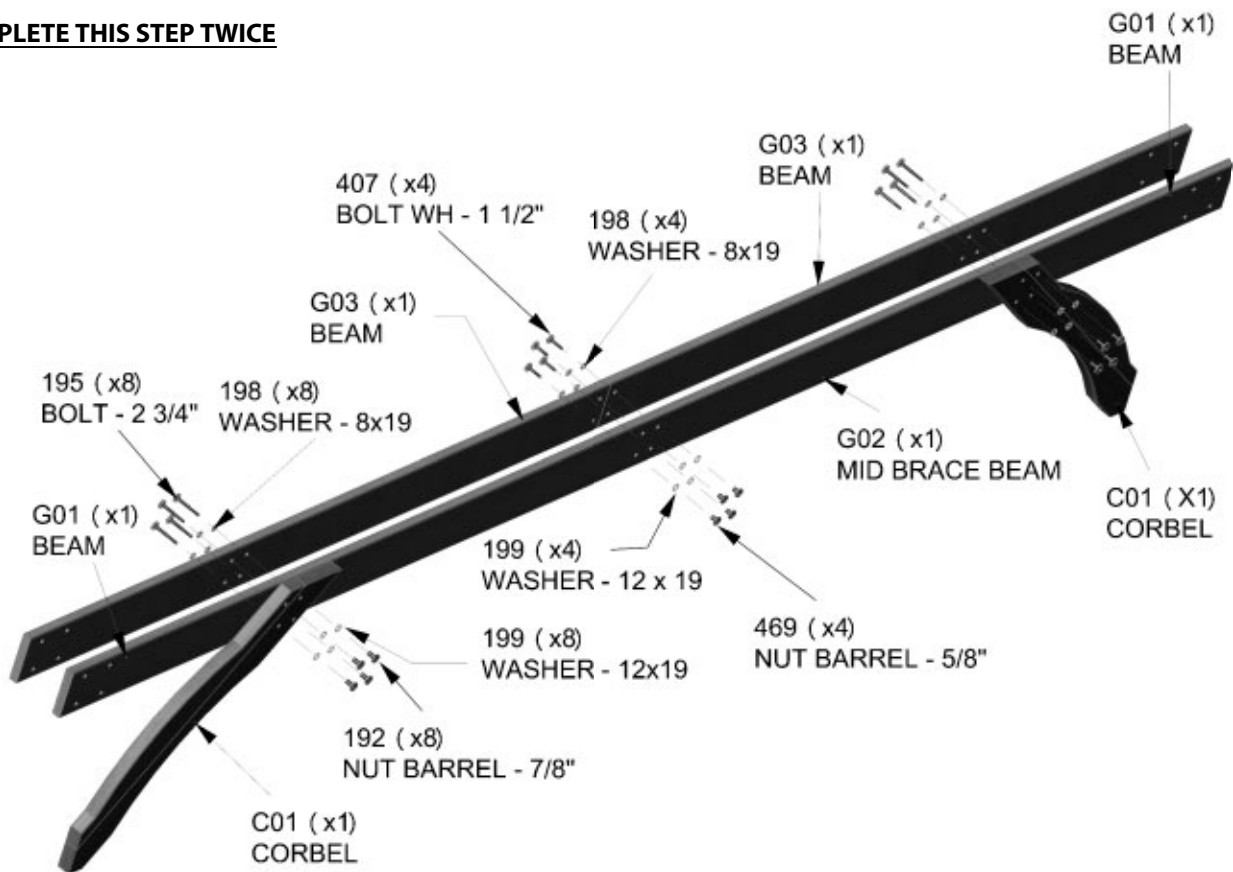

NOTE: MID BRACE G02 IS TO BE PLACED BETWEEN CORBELS C01 & BEAMS G03.

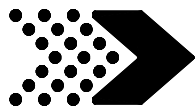

H100792 | LAG SCREW WH BLK
(4) | 1/4x3



H100405 | WASHER LOCK
(4) | EXT BLK 6x15



H100765 | BOLT WH BLK
(16) | 5/16x8



H100193 | NUT BARREL
(16) | WH BLK
5/16x1-1/2

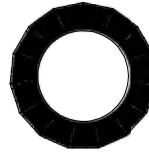

H100199 | WASHER LOCK
(16) | EXT BLK
12x19

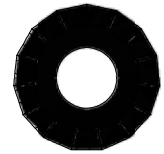

H100198 | WASHER LOCK
(16) | EXT BLK
8x19

COMPLETE THIS STEP TWICE

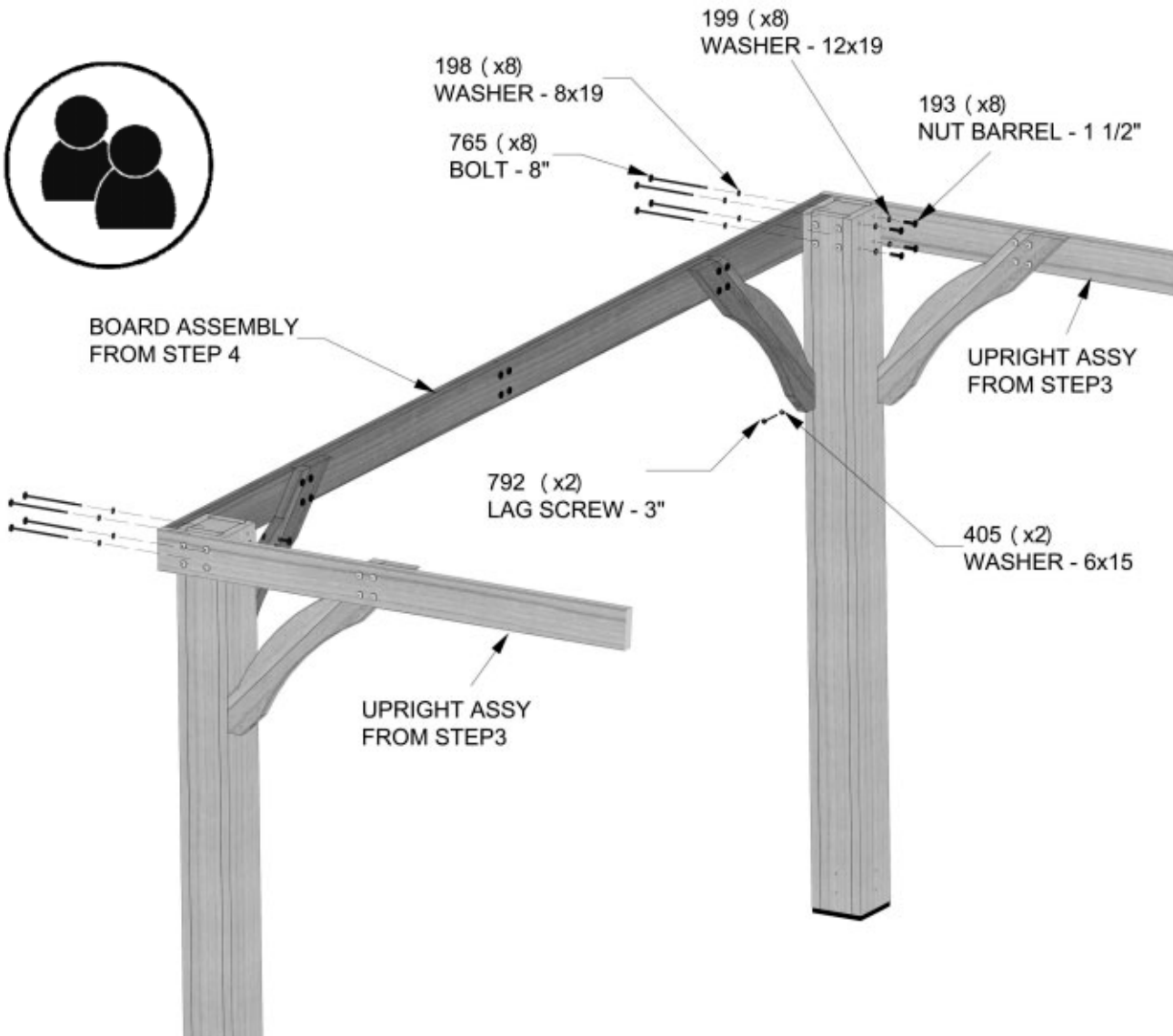

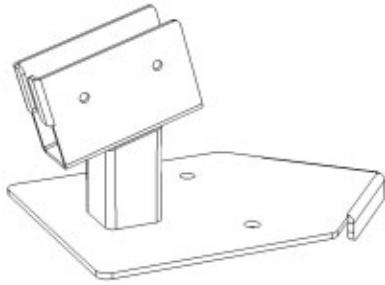
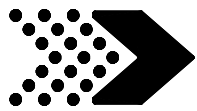

A4M01178 | POST CLIP
(4)



H100460 | LAG SCREW
(8) | WH BLK
1/4x1



NOTE:
USING THE POST CLIP AS A
TEMPLATE PREDRILL WITH A
1/8" DRILL BIT TO PREVENT
SPLITTING ON POSTS.

REPEAT ON ALL FOUR CORNERS

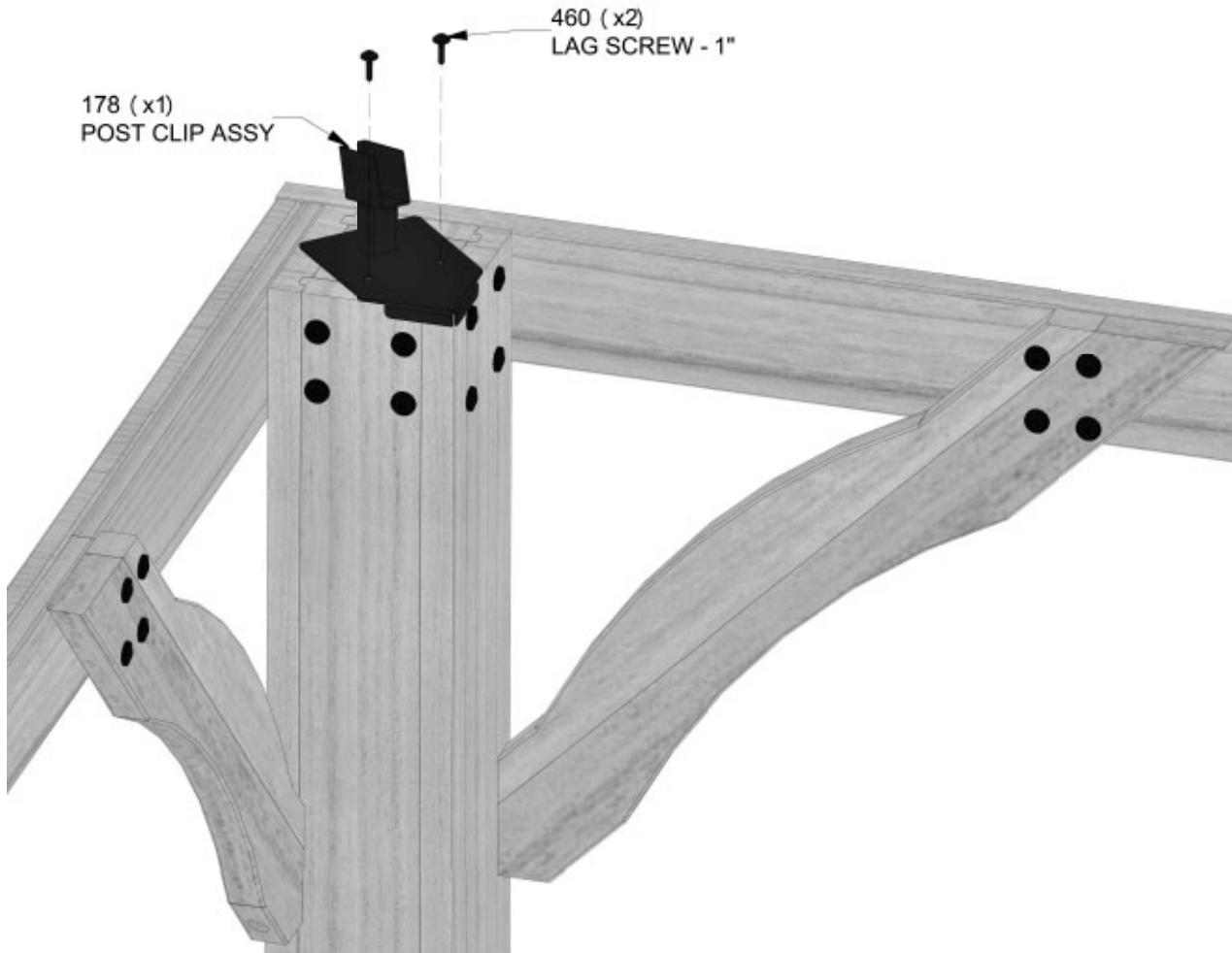

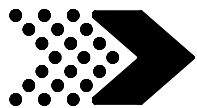

H18 | ROOF SUPPORT - W4L14526
(1) | 1"x3 3/8"x48" (24x86x1220)

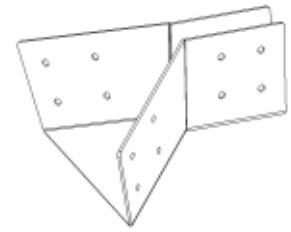

A4M01184 | PANEL SUPPORT BRACKET
(2)



H100385 | SCREW PFH BLK
(8) | 8x1



H100379 | T-NUT BLK
(2) | 5/16



NOTE:
ALIGN PILOT HOLES IN ROOF SUPPORT
BOARD ENDS WITH HOLES IN PANEL
SUPPORT BRACKET.

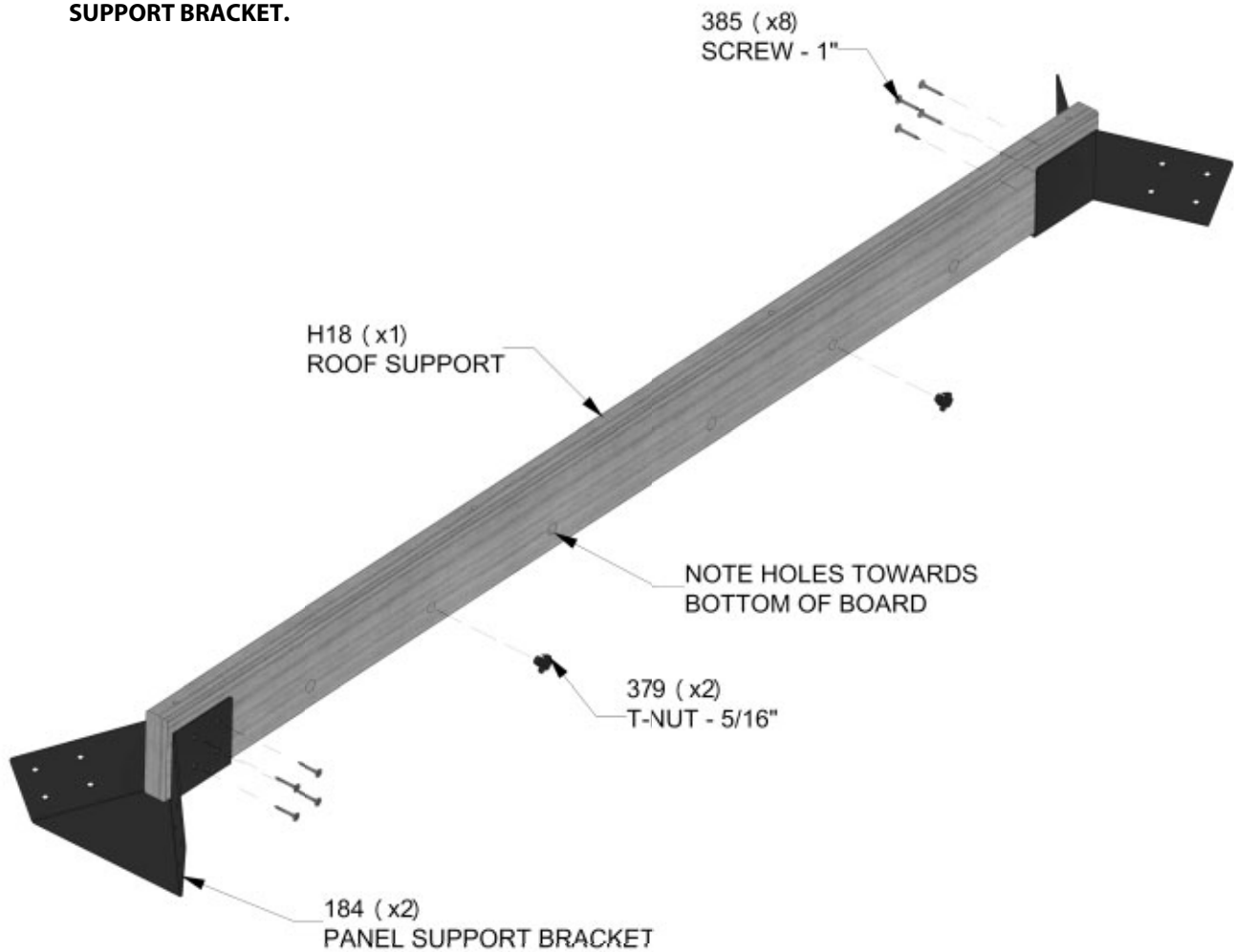

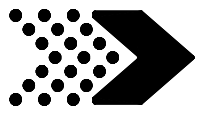

H19 | ROOF SUPPORT- W4L14527
(4) | 1"x3 3/8"x74 7/8" (24x86x1904)



H100385 | SCREW PFH BLK
(16) | 8x1

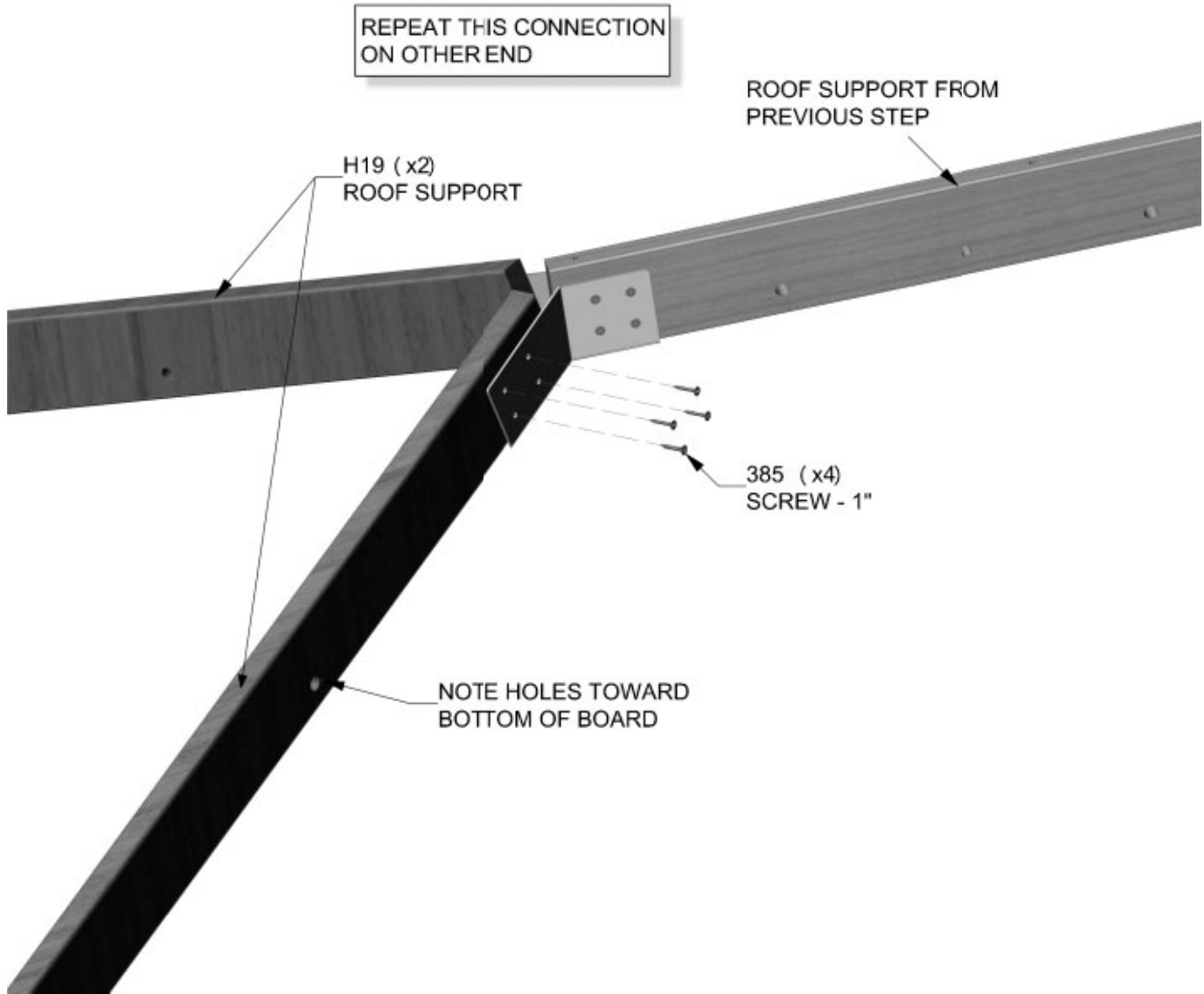

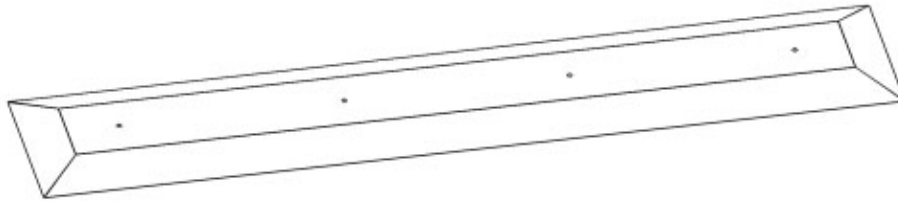
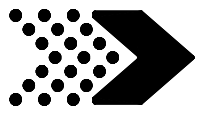

A4M01204 | RIDGE PEAK CAP
(1)



A4M01205 | METAL SPACER
(4)



H100792 | LAG SCREW WH BLK
(4) | 1/4x3



H101034 | WEATHER PROOF
(x4) | WASHER

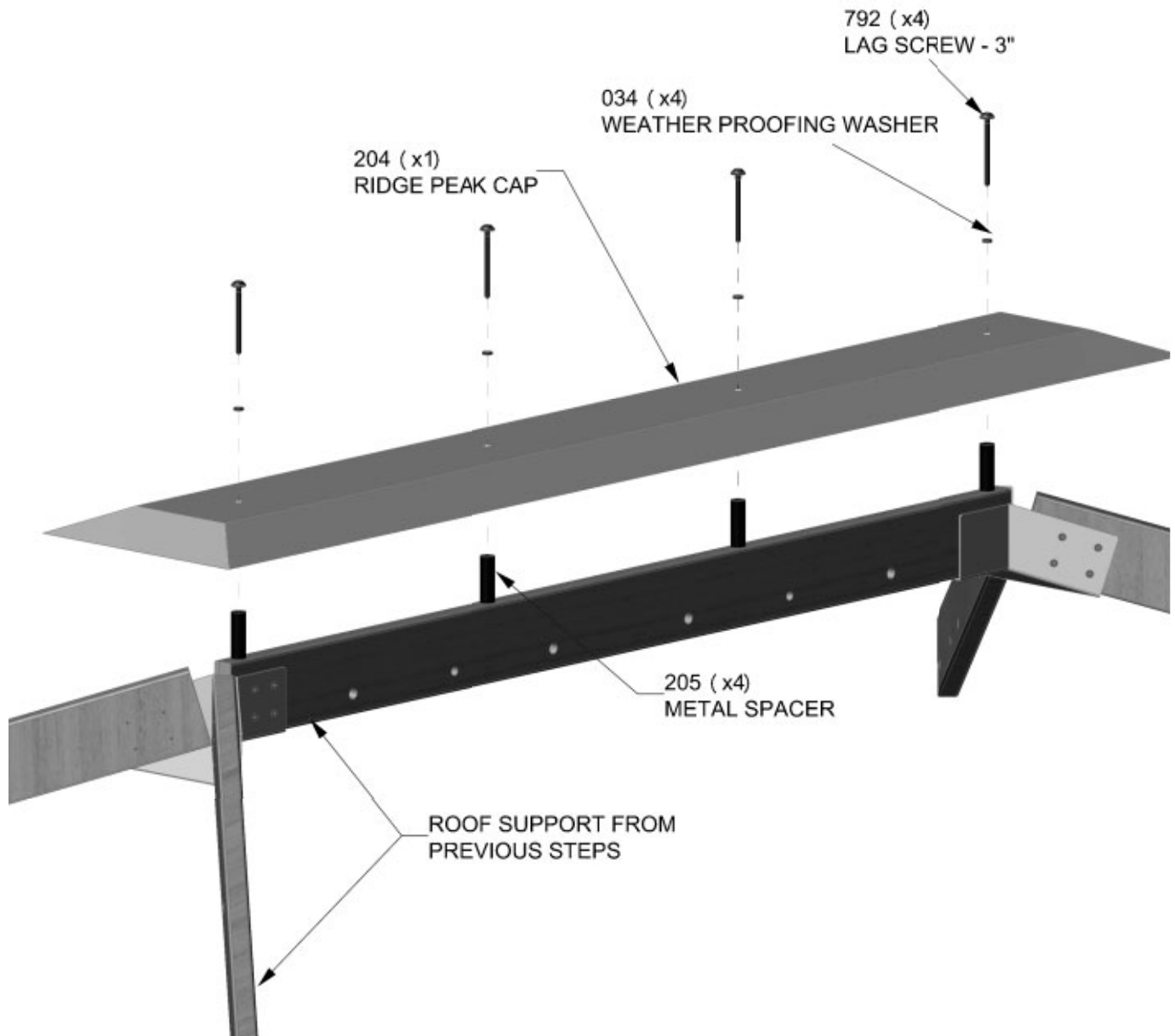

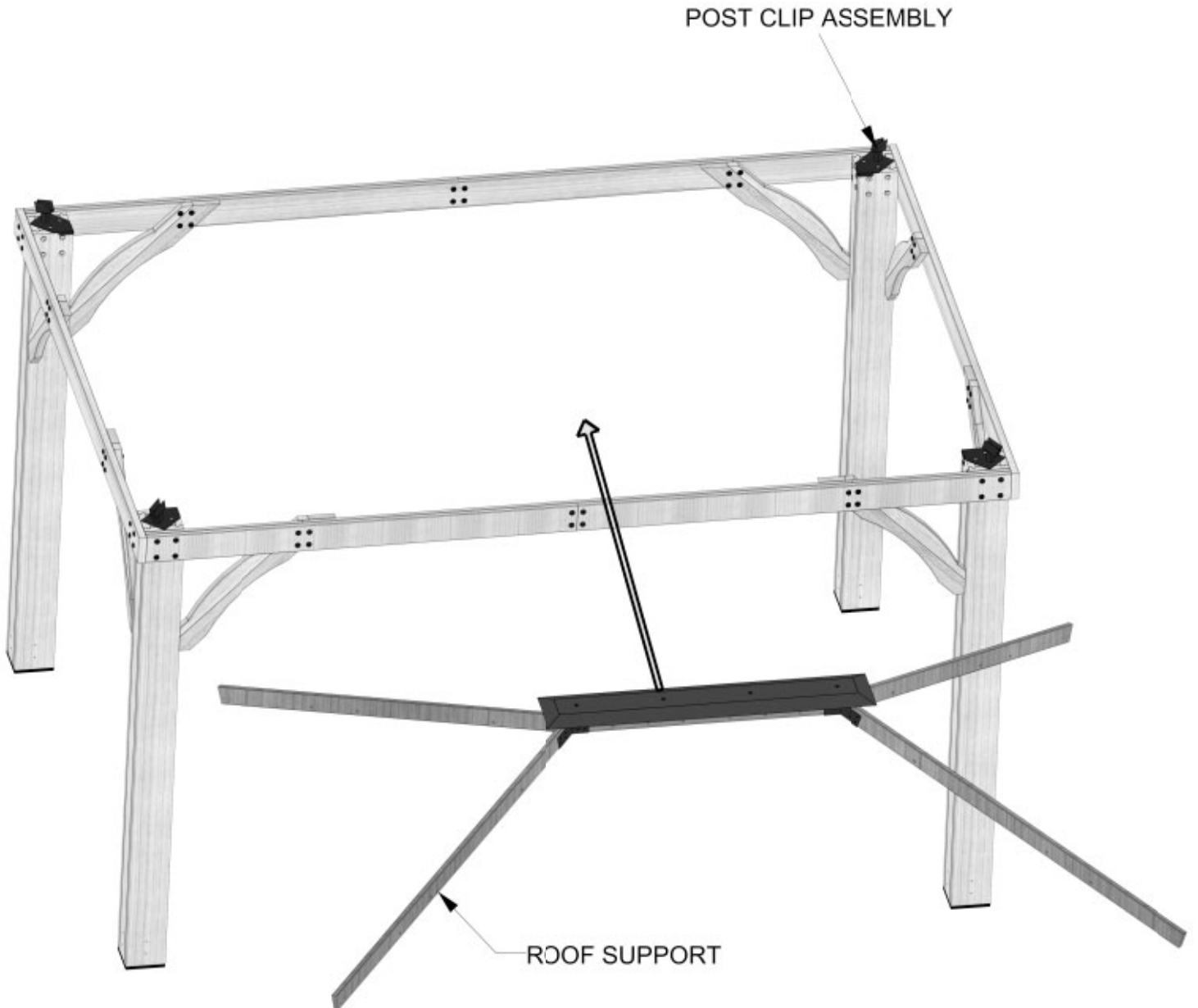
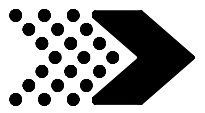

CAREFULLY RAISE AND INSERT FOUR CORNERS OF ROOF SUPPORT INTO POST CLIP ASSEMBLIES

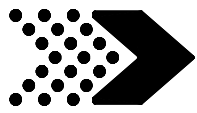

H100385 | SCREW PFH BLK
(12) | 8x1

SLIDE ROOF SUPPORT BOARDS INTO POST CLIP ASSEMBLIES. SECURE AS SHOWN.

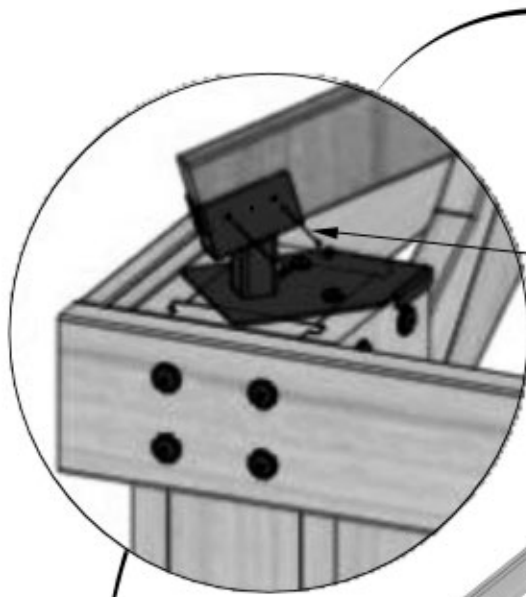

385 (x12)
SCREW-1"



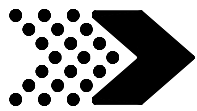

H02 | ROOF JOIST- W4L14430
(2) | 1"x3 3/8"x46 3/4" (24x86x1188)

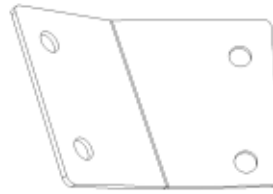

A4M01193 | PANEL BRACKET
(2)

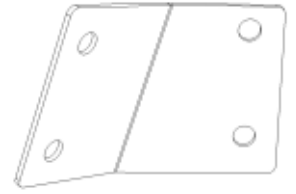

A4M01191 | PANEL BRACKET
(2)



H100171 | BOLT WH BLK
(8) | 1/4x1



H100398 | T-NUT BLK
(8) | 1/4

COMPLETE THIS STEP TWICE

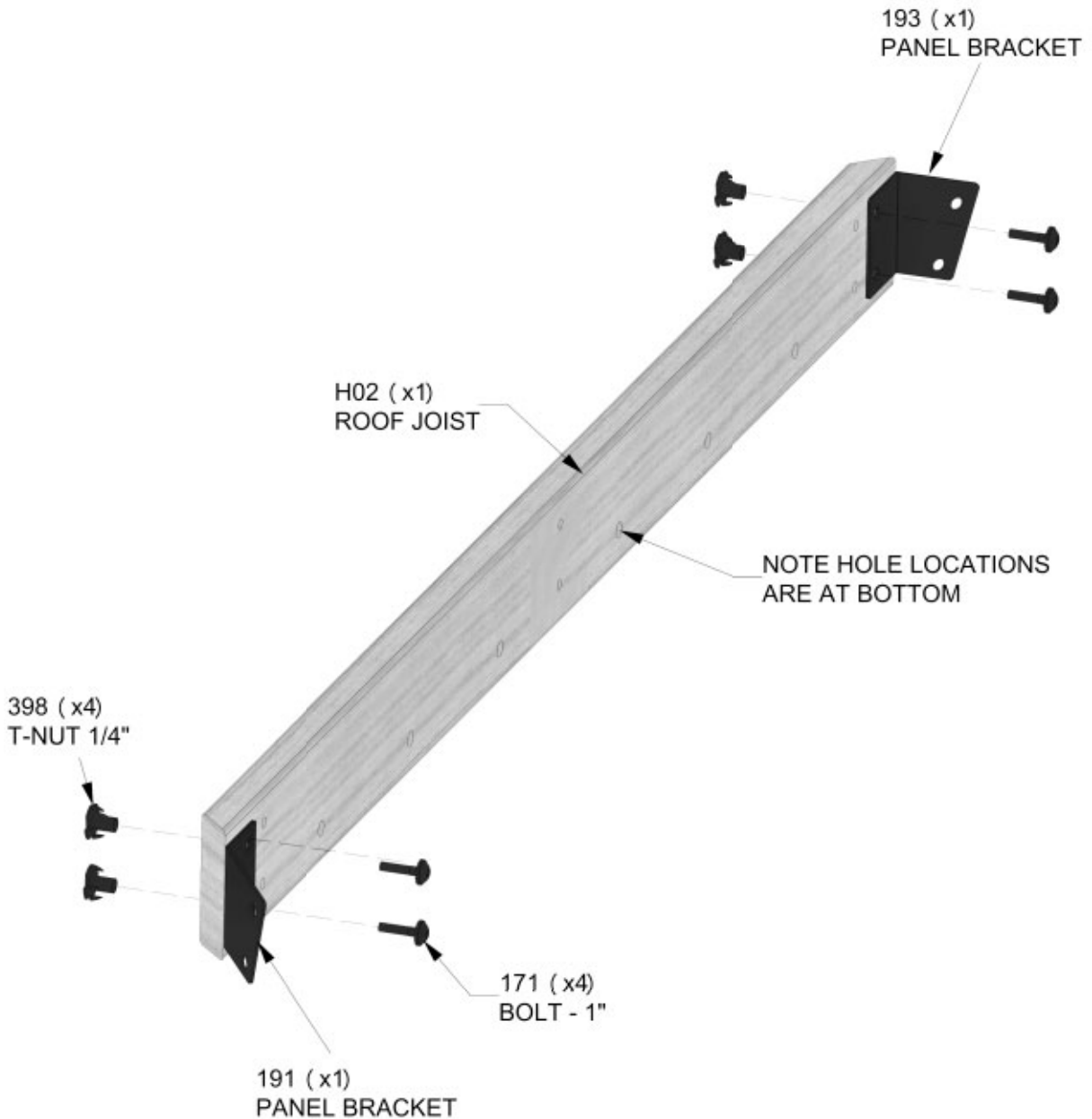

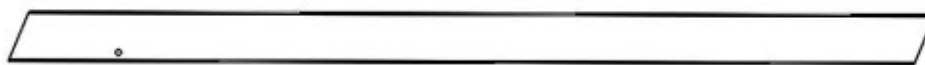

E02 | RAFTER- W4L14434
(4) | 1 3/8"x3 3/8"x63 7/8" (36x86x1622)



E11 | RAFTER- W4L14528
(2) | 1 3/8"x3 3/8"x63 7/8" (36x86x1622)



H01 | ROOF JOIST- W4L14429
(2) | 1"x3 3/8"x88 1/8" (24x86x2240)



H09 | ROOF JOIST- W4L14428
(2) | 1"x3 3/8"x88 3/16" (24x86x2240)



H100171 | BOLT WH BLK
(8) | 1/4x1



H100398 | T-NUT BLK
(8) | 1/4



H101030 | SCREW CONFIRMAT BLK
(12) | 7x2

COMPLETE THIS STEP TWICE

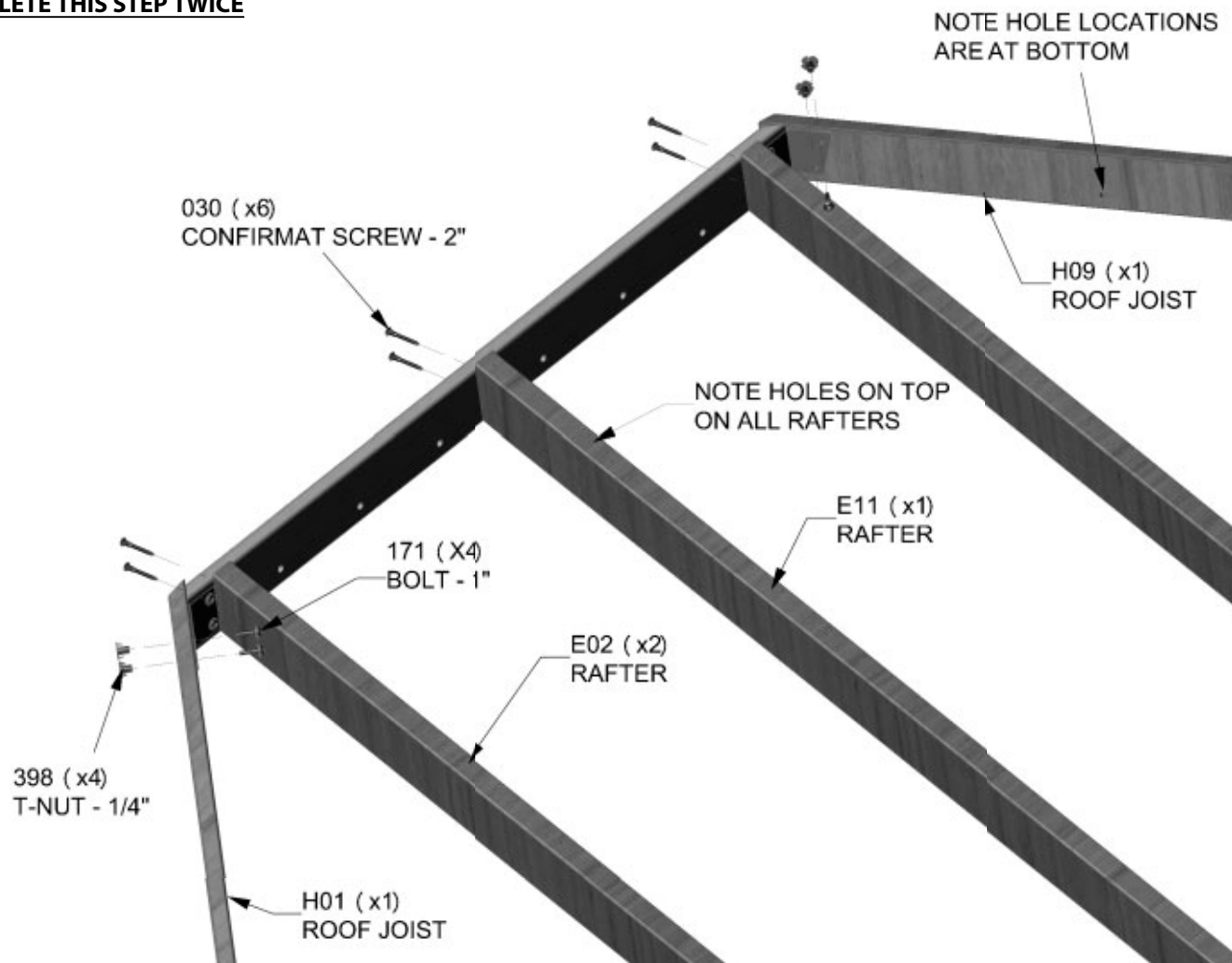



Q01 | ROOF JOIST- W4L14435
(4) | 1"x4 7/16"x83 3/4" (24x112x2128)



E01 | RAFTER- W4L14431
(2) | 1 3/8"x3 3/8"x44" (36x86x1117)



E03 | RAFTER- W4L14432
(2) | 1 3/8"x3 3/8"x20 7/16" (36x86x519)



E06 | RAFTER - W4L14524
(2) | 1 3/8"x3 3/8"x20 7/16" (36x86x519)



E04 | RAFTER- W4L14523
(2) | 1 3/8"x3 3/8"x44" (36x86x1117)



H100382 | SCREW PFH BLK
(8) | 8x1 3/4



H101030 | SCREW CONFIRMAT BLK
(44) | 7x2

COMPLETE THIS STEP TWICE



NOTE HOLE LOCATIONS
ARE AT BOTTOM

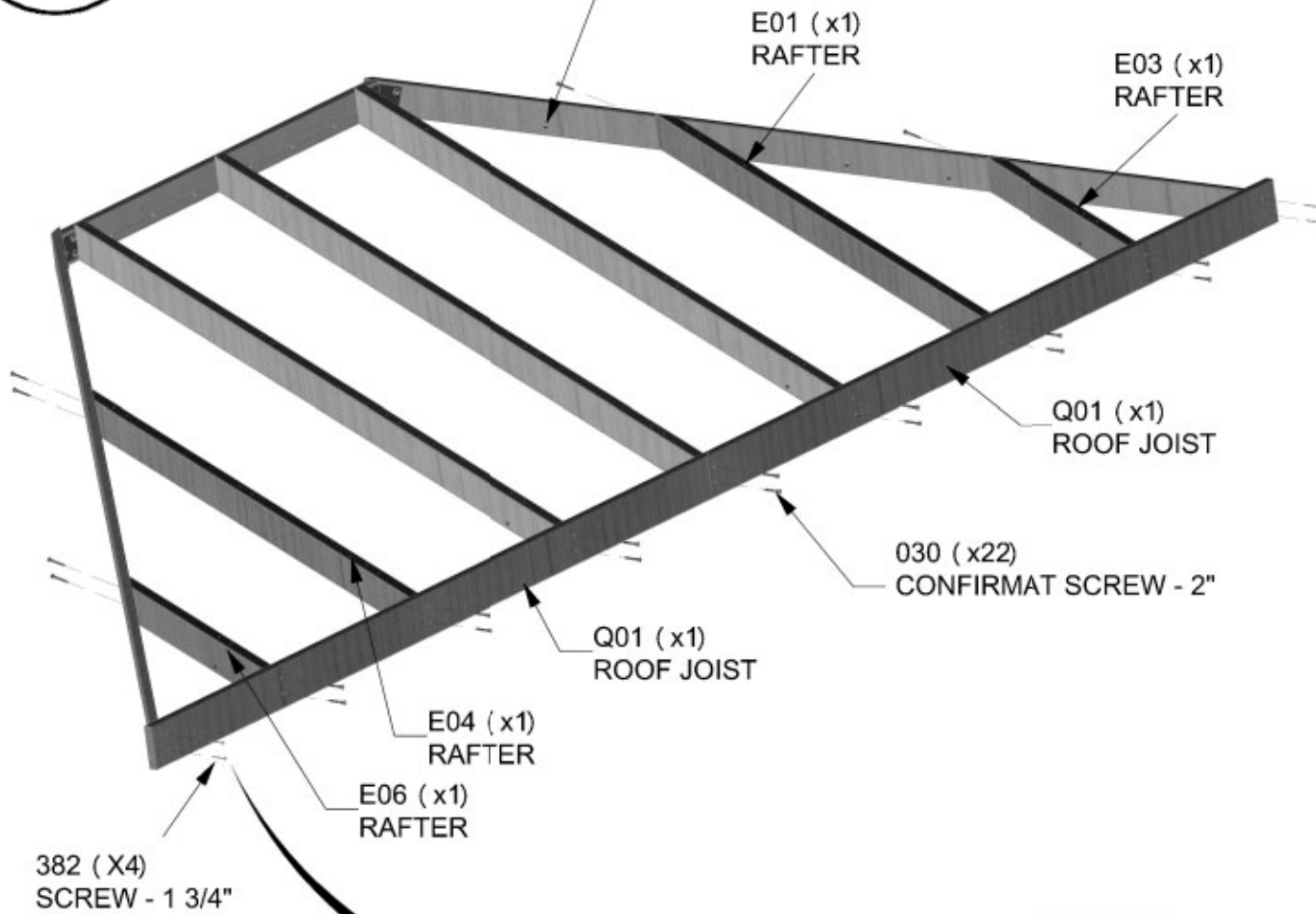

SEE STEP 14B FOR FINAL END SCREW INSTALLATION DETAILS



COMPLETE THIS STEP TWICE



NOTE:
LOCATE THE RAFTER
1" [25mm] FROM EDGE
BEFORE DRILLING PILOT
HOLES

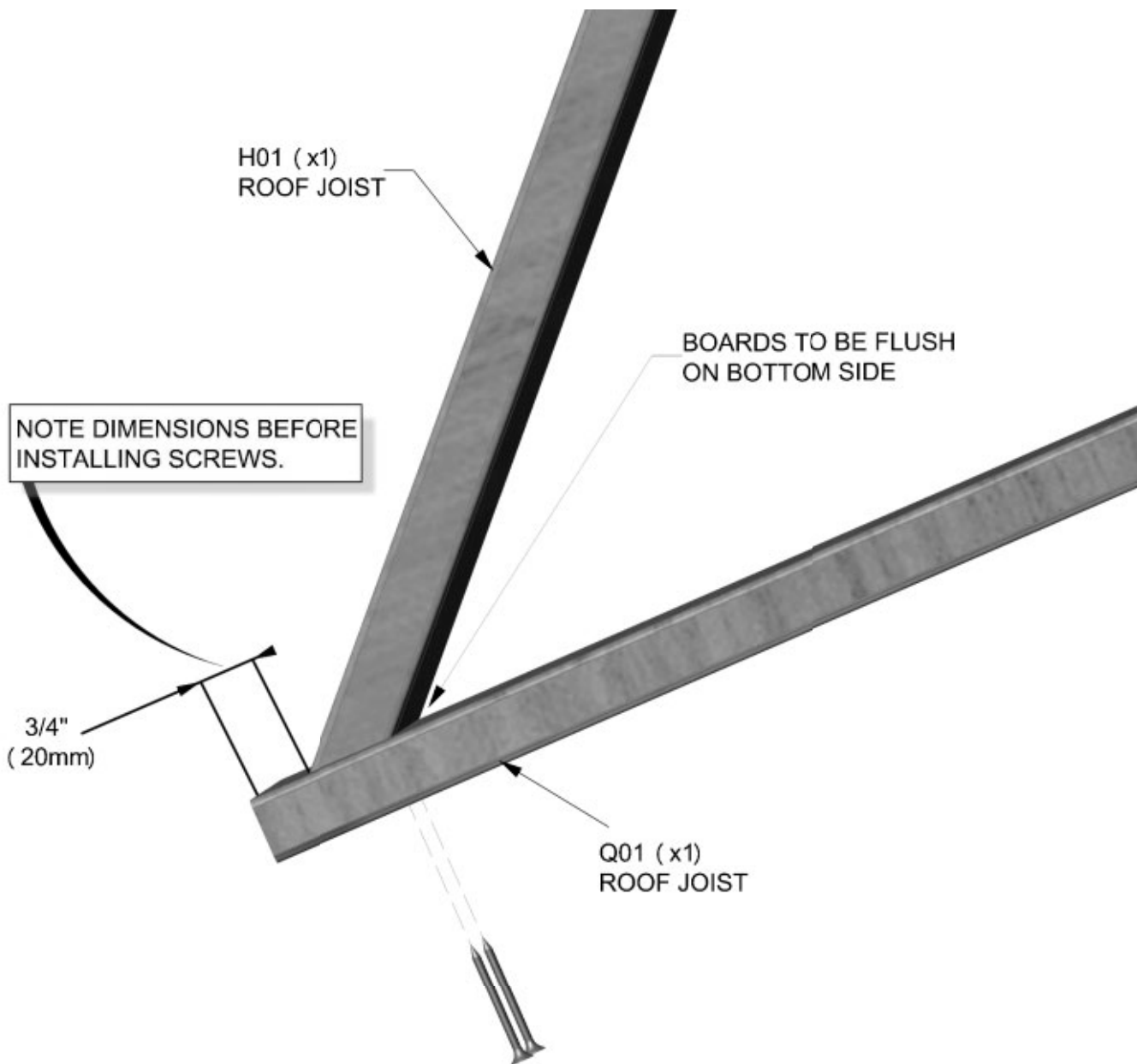
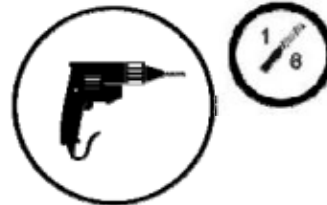

DO NOT INSTALL THESE SCREWS UNTIL ALL RAFTERS, AND JOIST ARE SECURE. USE A 1/8" DRILL BIT & BOARD Q01 AS A GUIDE TO PRODUCE PILOT HOLES IN THE H01 ROOF JOIST FROM PREVIOUS STEPS. REPEAT ON OTHER END TO H09 ROOF JOIST. FASTEN 1 3/4" SCREWS.

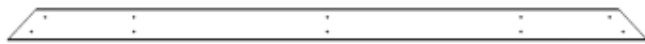

H03 | PURLIN - W4L14420
(2) 1"x3 3/8"x68 3/8" (24x86x1736)

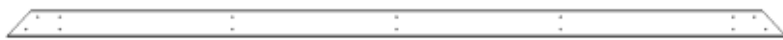

H04 | PURLIN - W4L14422
(2) 1"x3 3/8"x98 3/16" (24x86x2494)



H05 | PURLIN - W4L14423
(2) 1"x3 3/8"x64 11/16" (24x86x1644)



H06 | PURLIN - W4L14424
(2) 1"x3 3/8"x64 11/16" (24x86x1644)



H07 | PURLIN - W4L14425
(4) 1"x3 3/8"x58 15/16" (24x86x1497)



H08 | PURLIN - W4L14426
(2) 1"x3 3/8"x42 3/4" (24x86x1086)



H17 | PURLIN - W4L14525
(2) 1"x1 3/8"x51 3/8" (24x34x1306)



H100391 | SCREW PFH BLK
(112) 8x2



H100200 | SCREW PFH BLK
(6) 8x1 1/2

COMPLETE THIS STEP TWICE

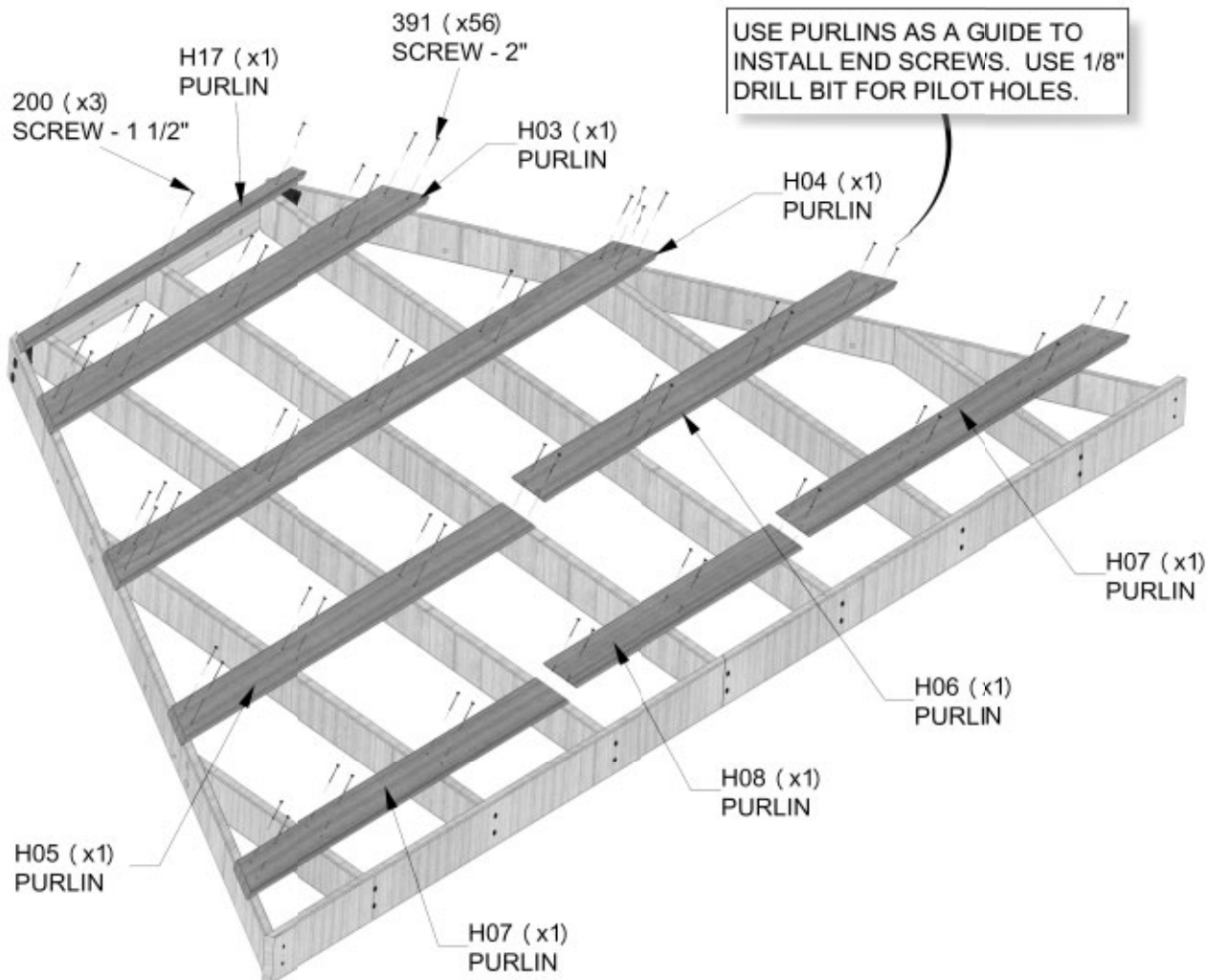

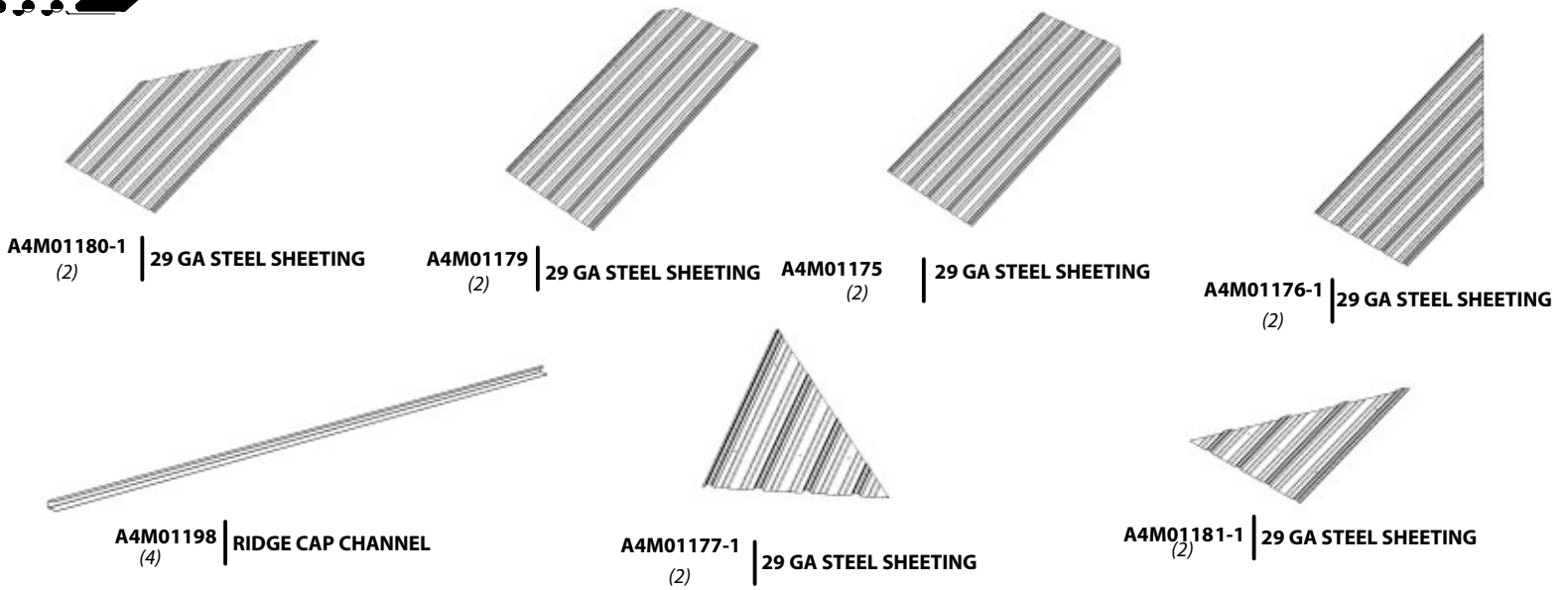
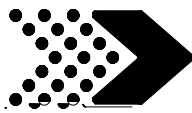

COMPLETE THIS STEP TWICE



NOTE:
REMOVE PROTECTIVE BLUE FILM FROM PANELS.

WARNING:
GLOVES SHOULD BE WORN WHEN HANDLING ROOF PANELS, EDGE TRIM & ALL RIDGES.

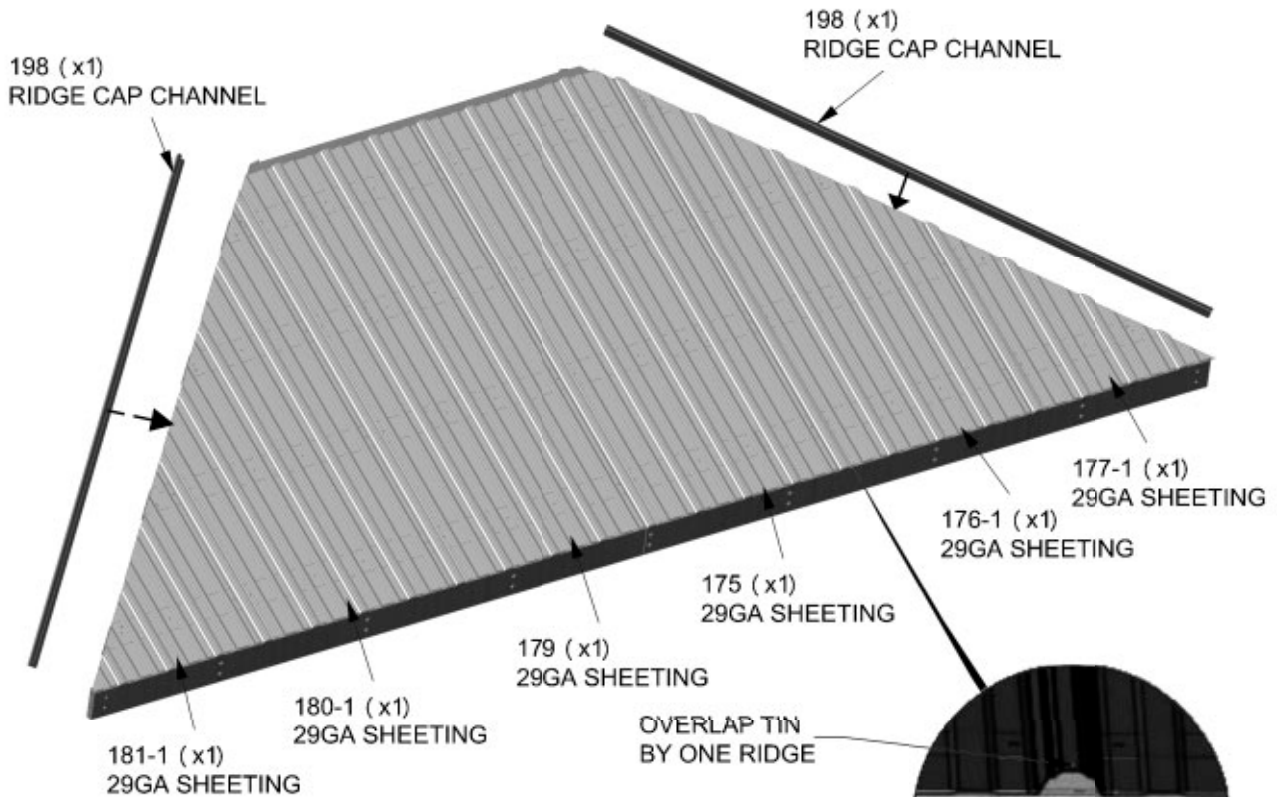

PLACE THE TWO CENTER PANELS FIRST (179 & 175) AND WORK OUTWARDS WITH THE OTHER FOUR PANELS. REPEAT SAME PATTERN ON OPPOSITE 14FT ROOF PANEL ASSEMBLY.



COMPLETE THIS STEP TWICE

198 (x1)
RIDGE CAP CHANNEL

INSERT RIDGE CAP CHANNEL ON
ROOF PANEL UNTIL THE CHANNEL
IS FULLY SEATED.

ROOF PANELS SHOULD BE FLUSH WITH BOTH
PURLINS AND ROOF JOIST

REPEAT THIS STEP ON OPPOSITE SIDE
OF ROOF PANEL ASSEMBLY



H100833 | SCREW
(128) | WOODGRIP
10x3/4

COMPLETE THIS STEP TWICE

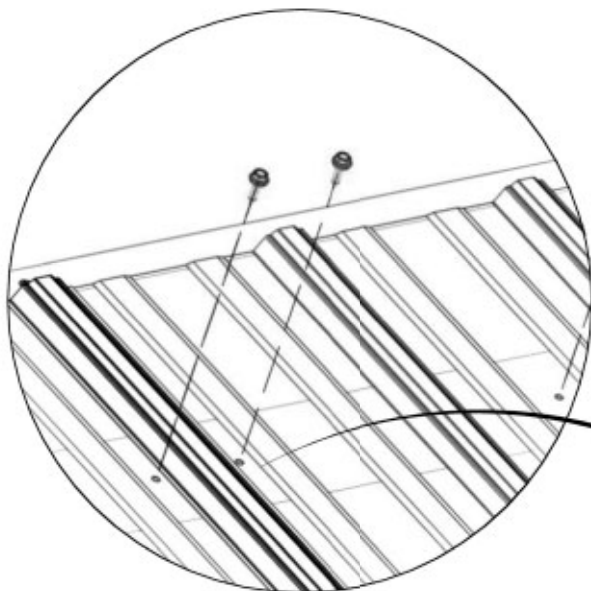

TIP:
ONCE PANELS AND RIDGE CAP CHANNELS
ARE IN PLACE AS DIRECTED IN PREVIOUS
STEP, ADD A FEW SCREWS TO EACH PANEL
TO ELIMINATE ANY MOVEMENT.

NOTE: USE HOLE LOCATIONS ON ROOF
PANELS FOR SCREW LOCATIONS

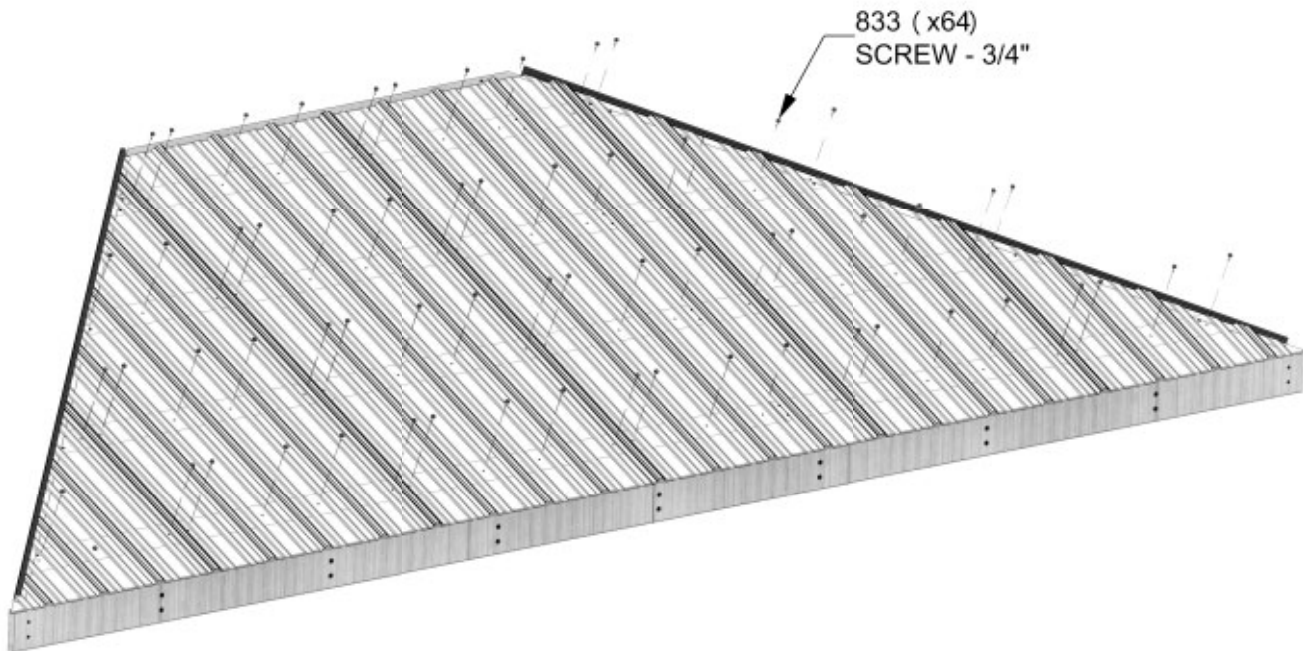



H100833 | SCREW
(12) | WOODGRIP
10x3/4

COMPLETE THIS STEP TWICE

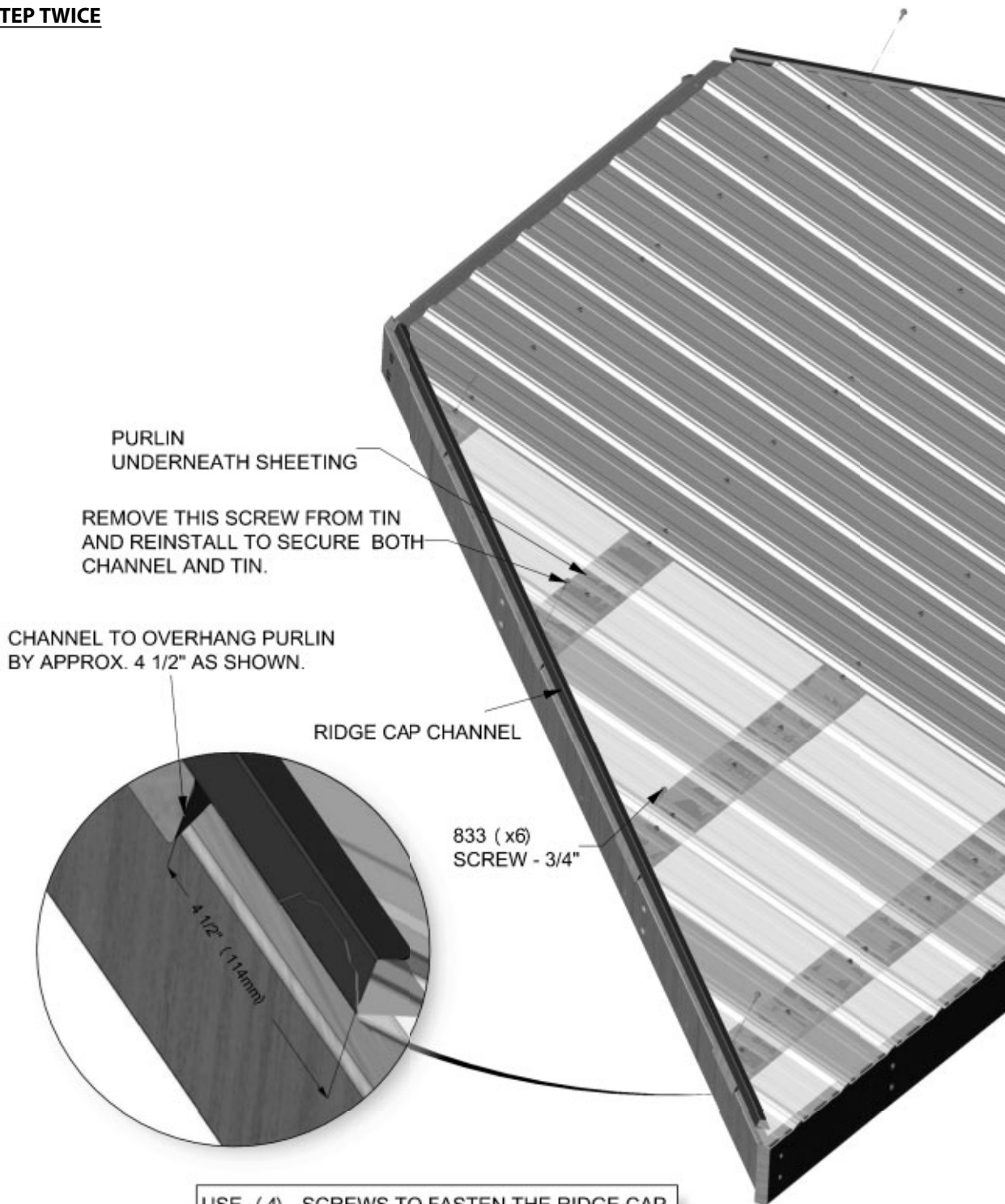

USE (4) SCREWS TO FASTEN THE RIDGE CAP CHANNELS TO THE PURLIN BOARDS. INSTALL THE SCREWS AS CLOSE AS POSSIBLE TO THE RIDGE CAP CHANNEL ENSURING THAT THEY GO THROUGH THE CHANNEL.

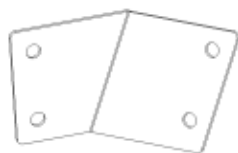

A4M01192 | PANEL BRACKET
(2)

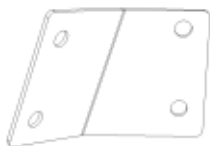

A4M01194 | PANEL BRACKET
(2)



H100398 | T-NUT BLK
(8) 1/4



H100171 | BOLT WH BLK
(8) 1/4x1

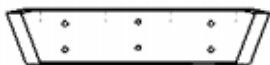

H11 | ROOF JOIST-W4L14438
(2) 1"x3 3/8"x15 15/16" (24x86x404)

COMPLETE THIS STEP TWICE

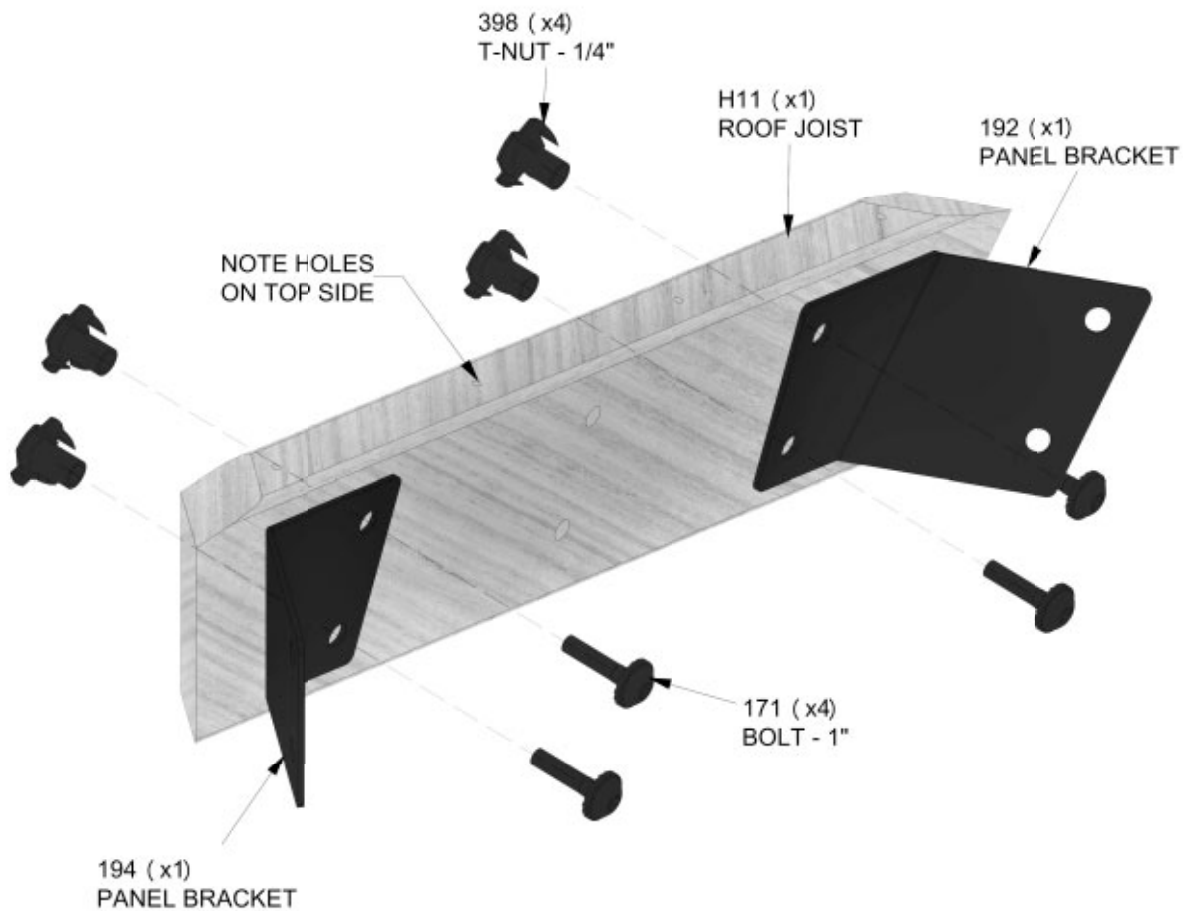



H10 | ROOF JOIST- W4L14437
(2) 1"x3 3/8"x76 13/16" (24x86x1952)



H12 | ROOF JOIST- W4L14440
(2) 1"x3 3/8"x76 13/16" (24x86x1952)



E09 | RAFTER- W4L14439
(2) 1 3/8"x3 3/8"x55 13/16" (36x86x1417)



H100171 | BOLT WH BLK
(8) 1/4x1



H100398 | T-NUT BLK
(8) 1/4



H101030 | SCREW CONFIRMAT BLK
(4) 7x2

COMPLETE THIS STEP TWICE

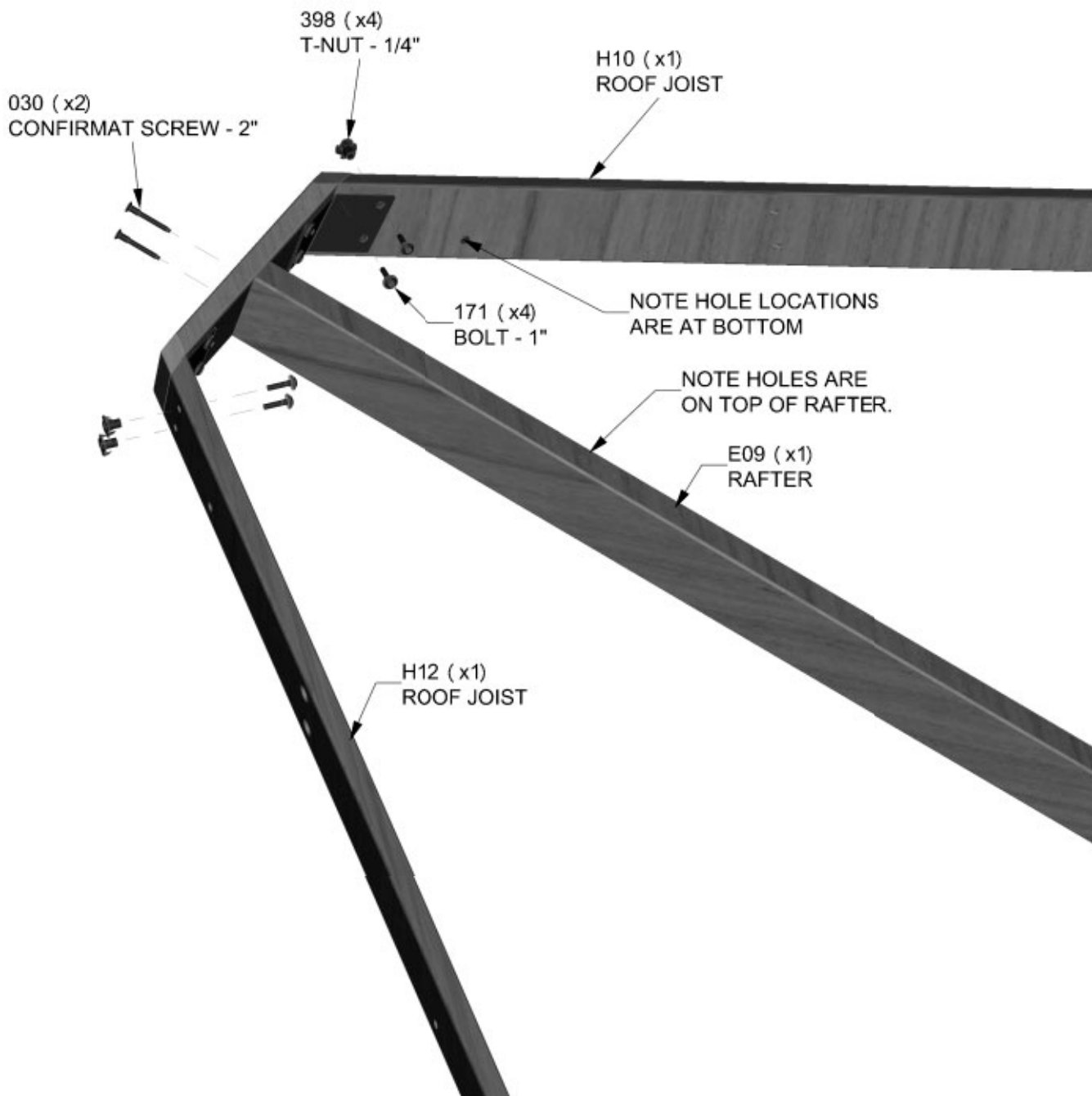



Q02 | ROOF JOIST- W4L14436
(4) | 1"x4 7/16"x60 11/16" (24x112x1542)



H101030 | SCREW CONFIRMAT BLK
(4) | 7x2



H100382 | SCREW PFH BLK
(8) | 8x1 3/4

COMPLETE THIS STEP TWICE

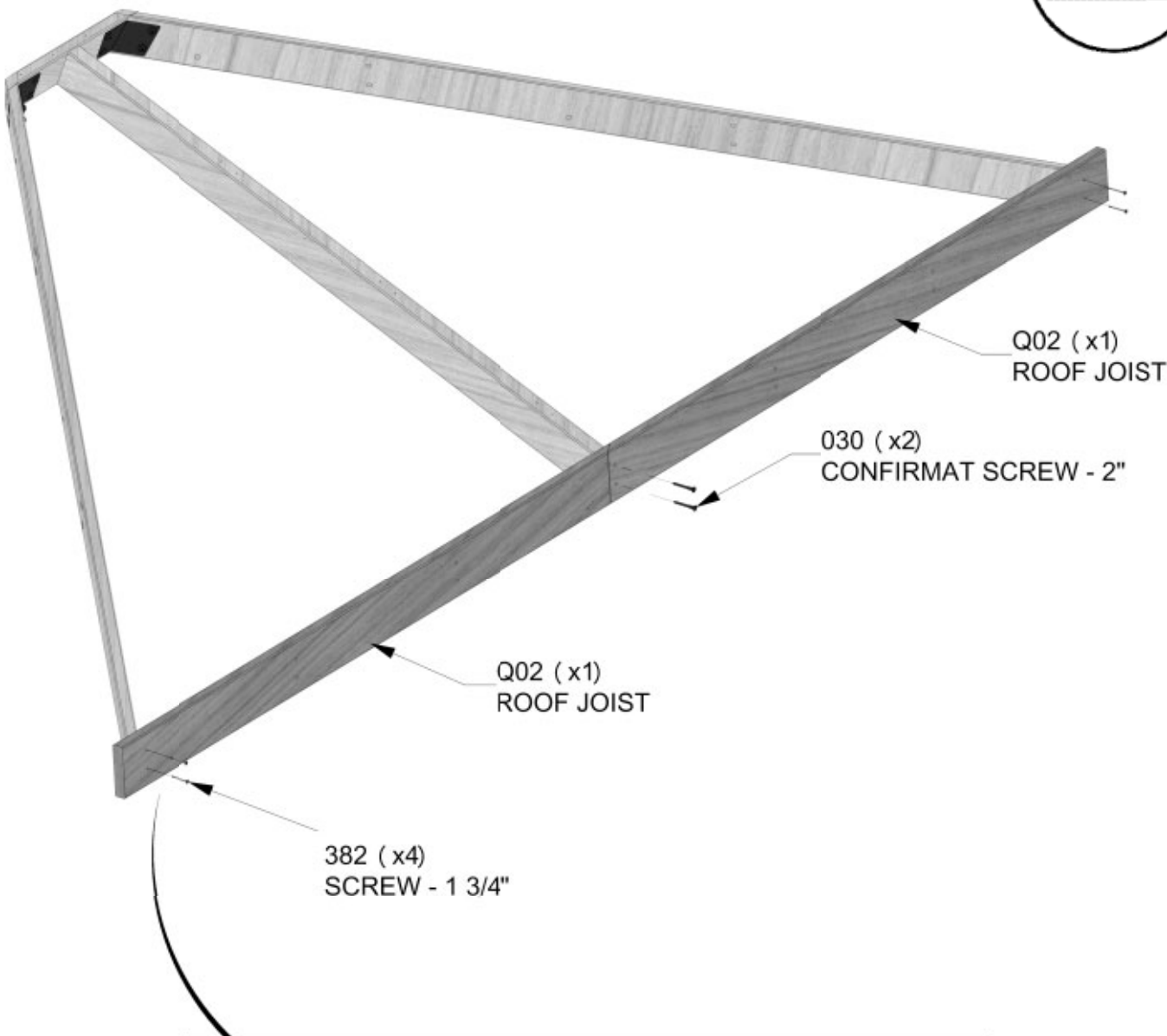

SEE STEP 22B FOR FINAL END SCREW INSTALLATION DETAILS



COMPLETE THIS STEP TWICE

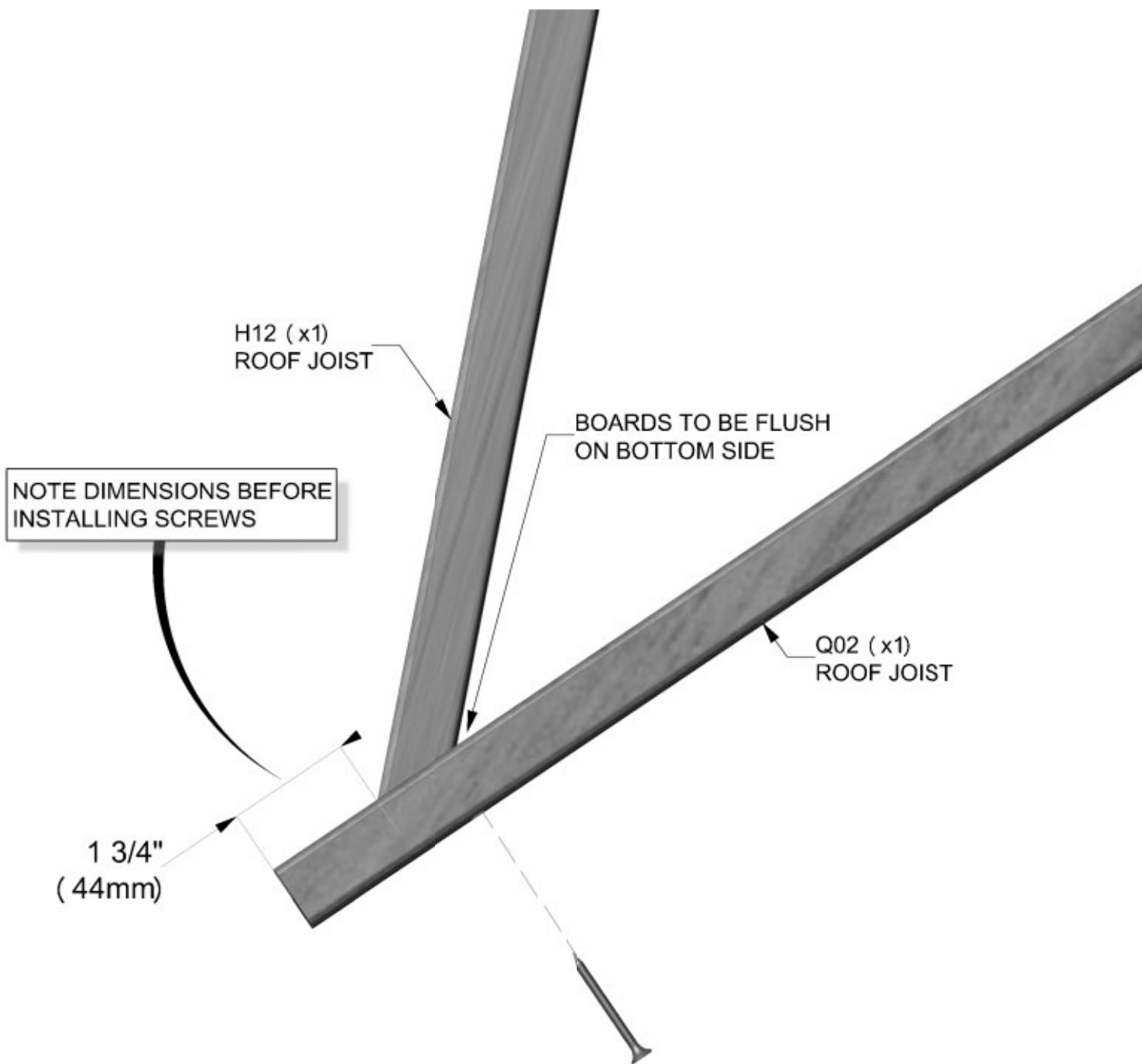

USE 1/8" DRILL BIT & BOARD Q02 AS A GUIDE TO PRODUCE PILOT HOLES IN THE H12 ROOF JOIST FROM PREVIOUS STEPS. REPEAT ON OTHER END TO H10 ROOF JOIST. FASTEN 1 3/4" SCREWS.



E05 | RAFTER - W4L14442
(2) 1 3/8"x3 3/8"x42 3/4" (36x86x1087)



E07 | RAFTER - W4L14444
(2) 1 3/8"x3 3/8"x42 7/8" (36x86x1087)



E08 | RAFTER - W4L14445
(2) 1 3/8"x3 3/8"x21 3/4" (36x86x553)



E10 | RAFTER - W4L14443
(2) 1 3/8"x3 3/8"x21 3/4" (36x86x553)



H101030 | SCREW CONFIRMAT BLK
(32) 7x2

COMPLETE THIS STEP TWICE

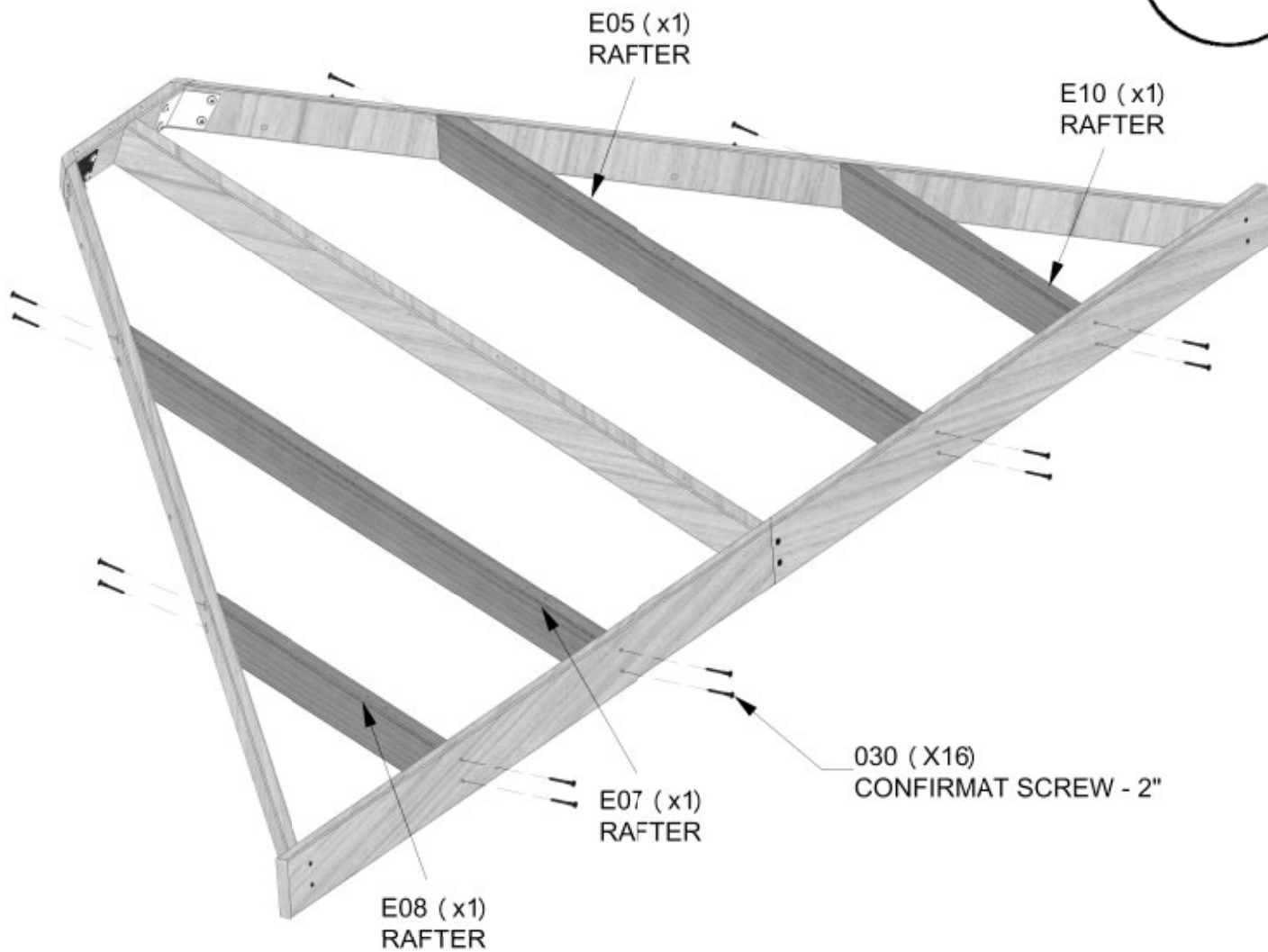

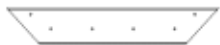

H13 | ROOF JOIST - W4L14446
(2) 1"x3 3/8"x20 1/4" (24x86x514)

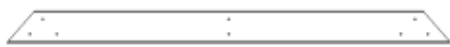

H14 | PURLIN - W4L14447
(2) 1"x3 3/8"x50 1/16" (24x86x1272)



H15 | PURLIN - W4L14448
(2) 1"x3 3/8"x79 7/8" (24x86x2030)



H16 | PURLIN - W4L14449
(2) 1"x3 3/8"x109 3/4" (24x86x2788)



H100391 | SCREW PFH BLK
(76) 8x2

COMPLETE THIS STEP TWICE

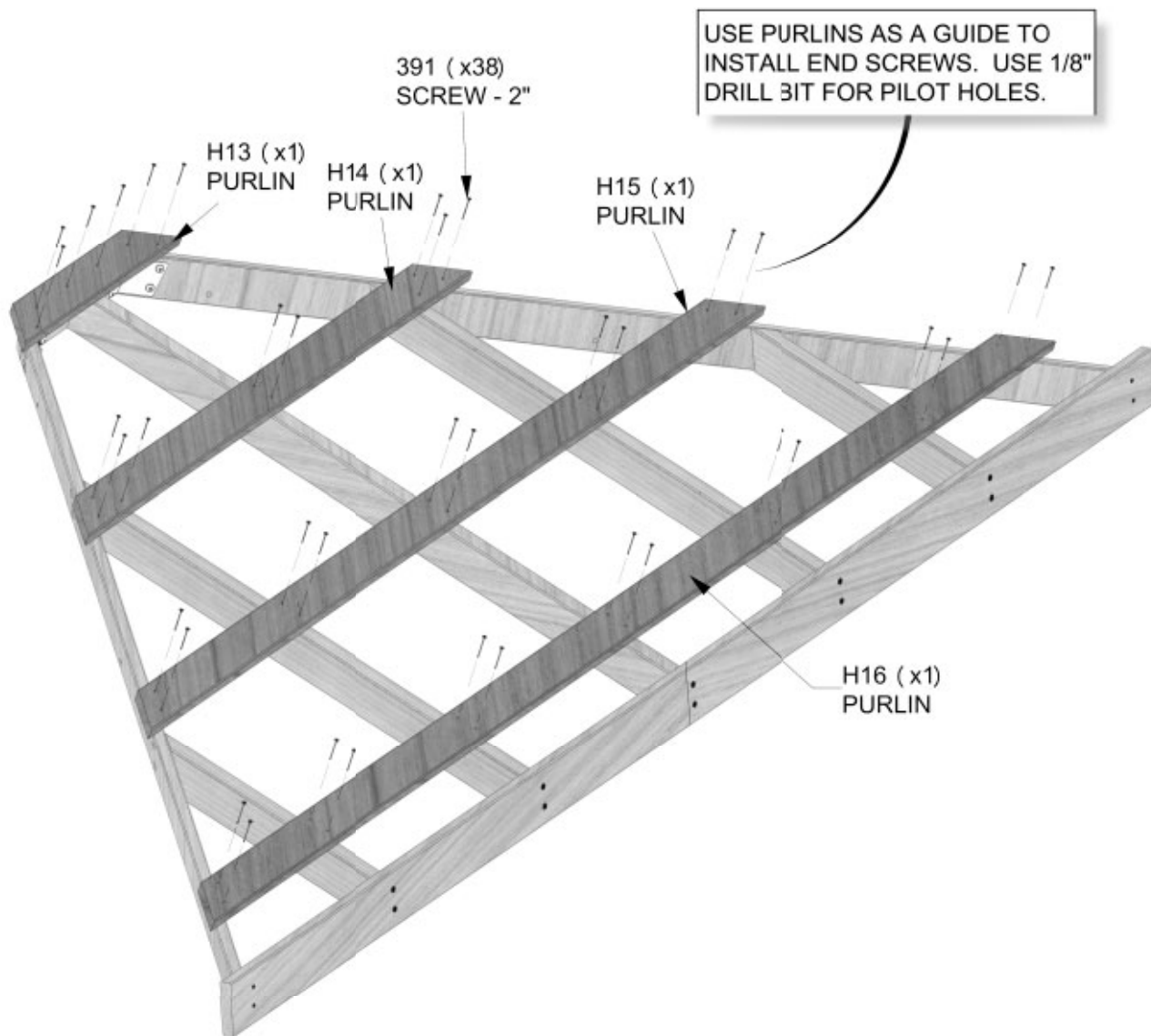



A4M01176-2 (2) | 29 GA STEEL SHEETING

A4M01177-2 (2) | 29 GA STEEL SHEETING

A4M01180-2 (2) | 29 GA STEEL SHEETING



A4M01181-2 (2) | 29 GA STEEL SHEETING

A4M01198 (4) | RIDGE CAP CHANNEL

COMPLETE THIS STEP TWICE



NOTE:
REMOVE PROTECTIVE BLUE FILM FROM PANELS.

WARNING:
GLOVES SHOULD BE WORN WHEN HANDLING ROOF PANELS, EDGE TRIM & ALL RIDGES.

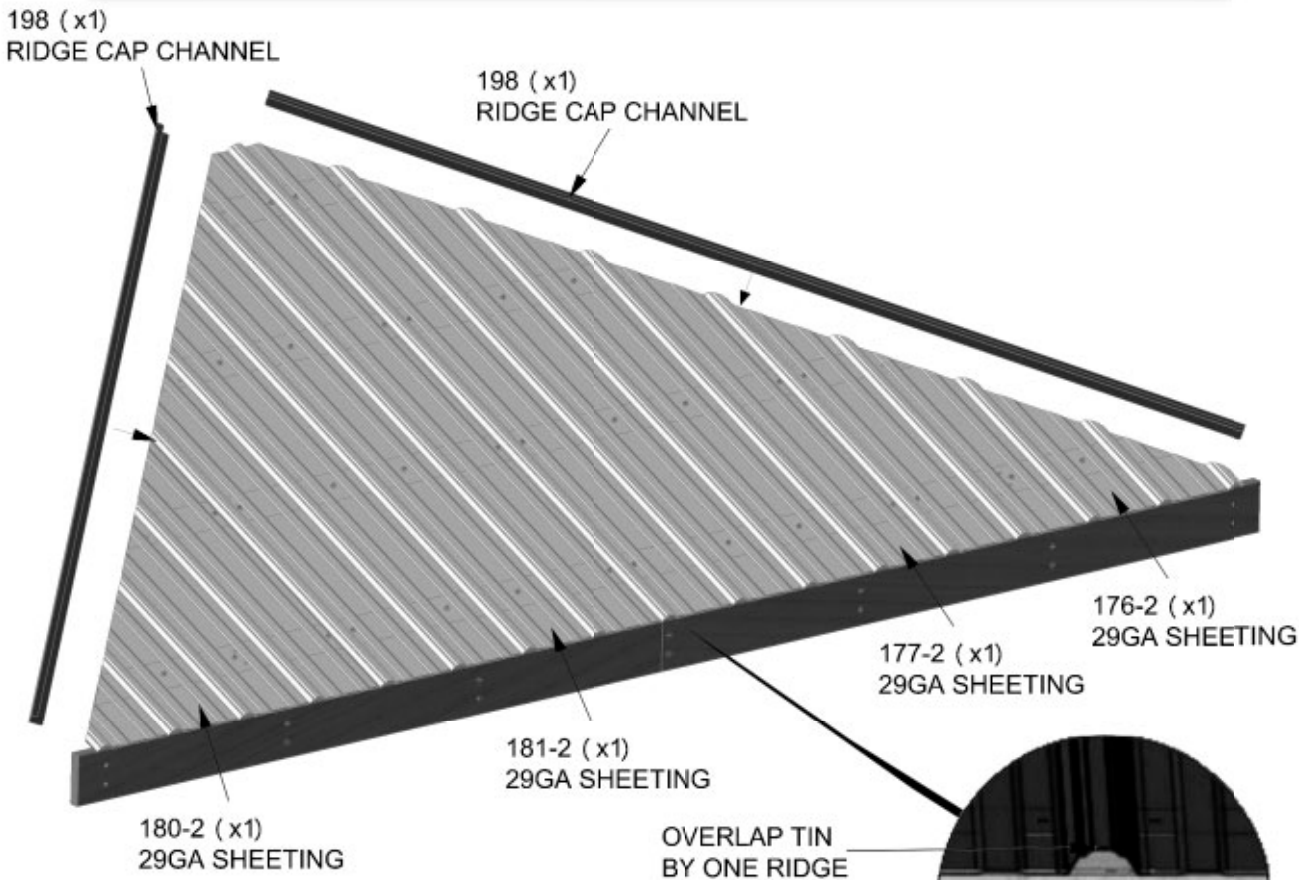

PLACE THE TWO CENTER PANELS FIRST (181-2 & 177-2) AND WORK OUTWARDS WITH THE OTHER TWO PANELS. REPEAT SAME PATTERN ON OPPOSITE 10FT ROOF PANEL ASSEMBLY.



H100833 | SCREW
(64) | WOODGRIP
10x3/4

COMPLETE THIS STEP TWICE

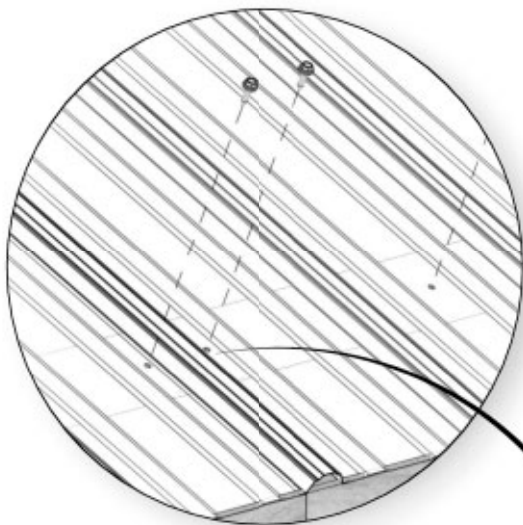

TIP:
ONCE PANELS AND RIDGE CAP CHANNELS
ARE IN PLACE AS DIRECTED IN PREVIOUS
STEP, ADD A FEW SCREWS TO EACH PANEL
TO ELIMINATE ANY MOVEMENT.

NOTE: USE HOLE LOCATIONS ON ROOF
PANELS FOR SCREW LOCATIONS.

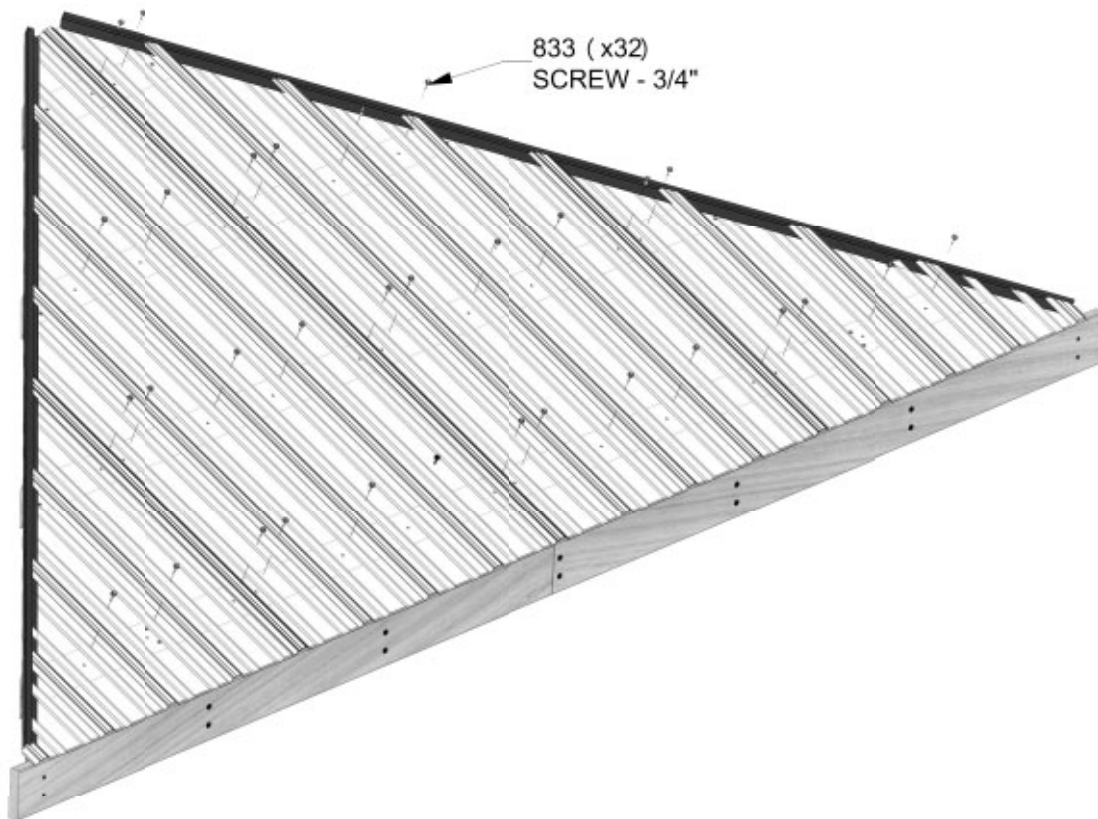



H100833 | SCREW
(16) | WOODGRIP
10x3/4

COMPLETE THIS STEP TWICE

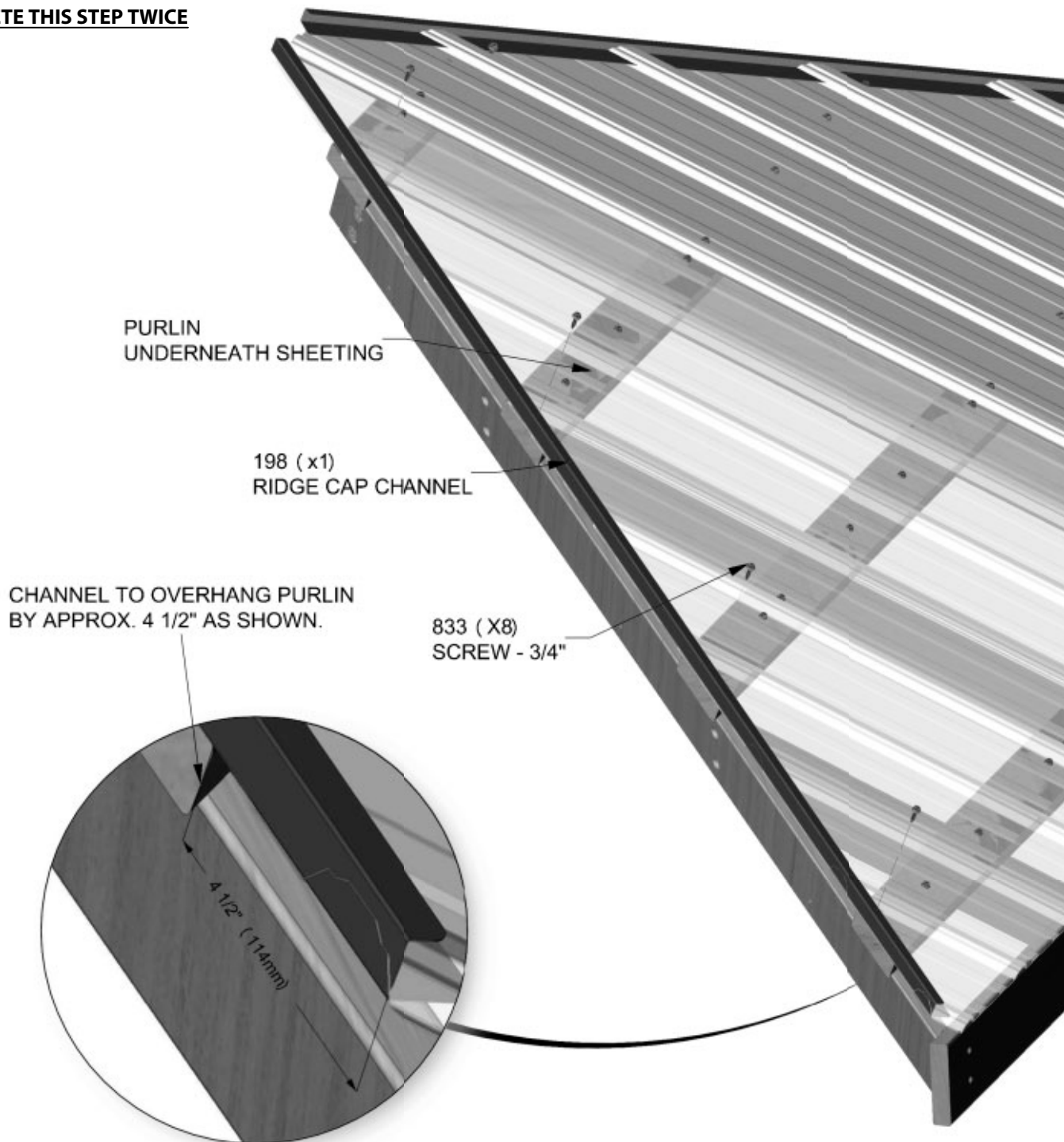

USE (4) SCREWS TO FASTEN THE RIDGE CAP CHANNELS TO THE PURLIN BOARDS. INSTALL THE SCREWS AS CLOSE AS POSSIBLE TO THE RIDGE CAP CHANNEL ENSURING THAT THEY GO THROUGH THE CHANNEL.

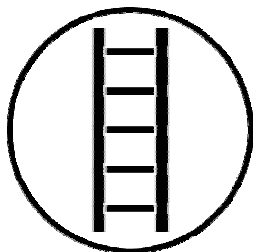

CAREFULLY SLIDE PANEL UNDER RIDGE CAP.

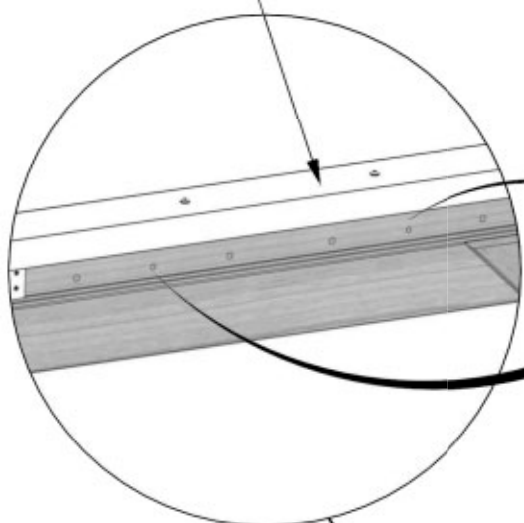

NOTE:
WARNING: GLOVES SHOULD BE WORN WHEN HANDLING ROOF PANELS.

- 1) PLACE LADDER TOWARD THE CENTER OF THE ROOF SUPPORT. IF NEEDED PLACE ANOTHER LADDER ON THE SIDE TO REACH AND HOLD THE BACK OF THE PANEL.
- 2) WITH AT LEAST TWO PEOPLE LIFT 14FT ROOF PANEL AND LAY ON TOP OF THE FRONT SUPPORT.
- 3) CAREFULLY WORK PANEL UP SLOWLY UNTIL IT MEETS WITH TOP CENTER ROOF JOIST. AVOID DRAGGING THE PANEL ACROSS FRONT SUPPORT AS DAMAGE COULD OCCOR TO THE SURFACES. ONCE PANELS AND ROOF SUPPORT HOLES ARE ALIGNED, ATTACH HARDWARE. SEE FOLLOWING STEPS FOR DETAILS.

NOTE THAT T-NUTS HAVE BEEN PREVIOUSLY INSTALLED FROM STEP 7 AND ARE IN THESE TWO HOLES AND ARE ON BACK SIDE OF ROOF SUPPORT BEFORE PROCEEDING WITH THIS STEP.

TIP: A THIRD PERSON PERSON IS SUGGESTED TO HELP SUPPORT THE PANEL OR HANDLE HARDWARE TO ATTACH PANELS.

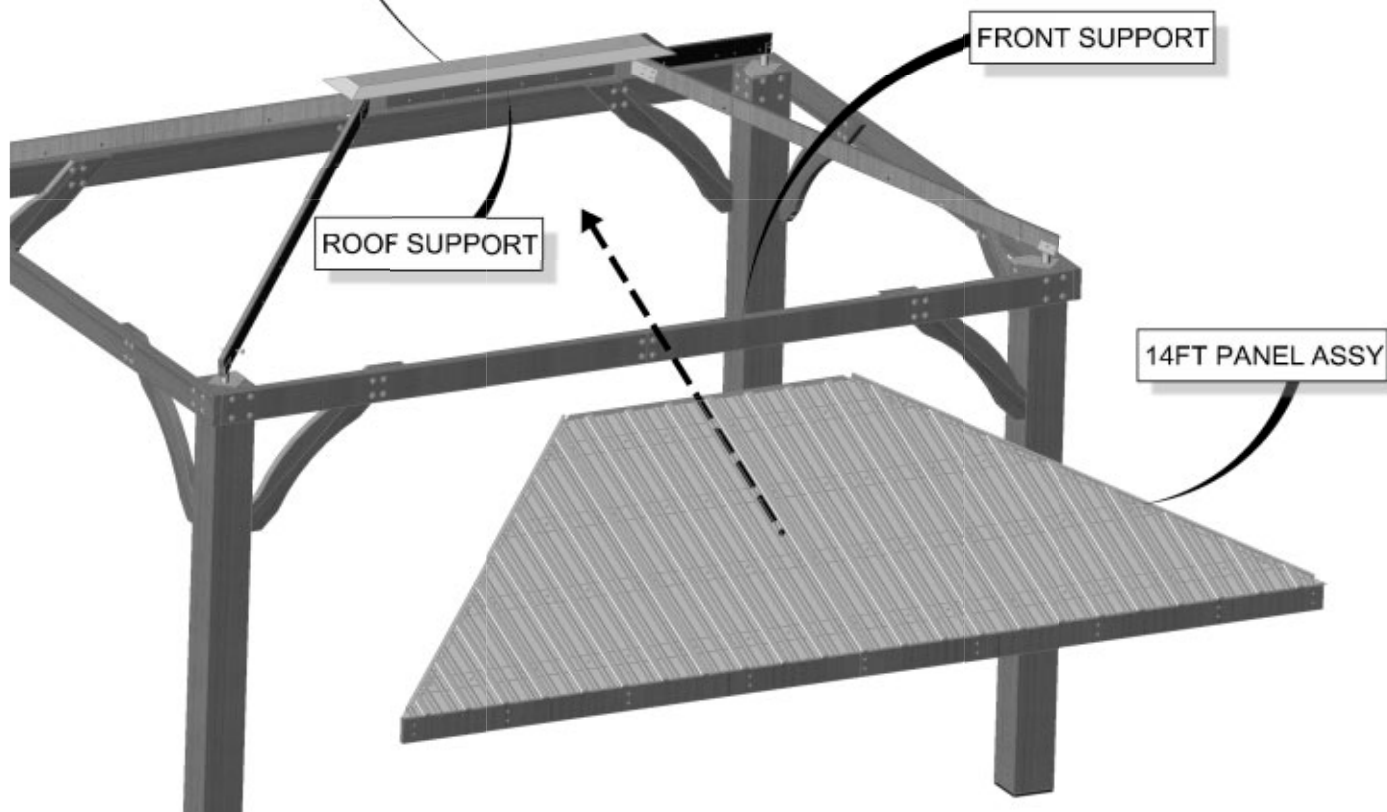



H100378 | BOLT WH BLK
(2) | 5/16x1-3/4



H100198 | WASHER LOCK
(2) | EXT BLK
8x19

TIP: THE USE OF THE CLAMP PROVIDED IS RECOMMENDED.

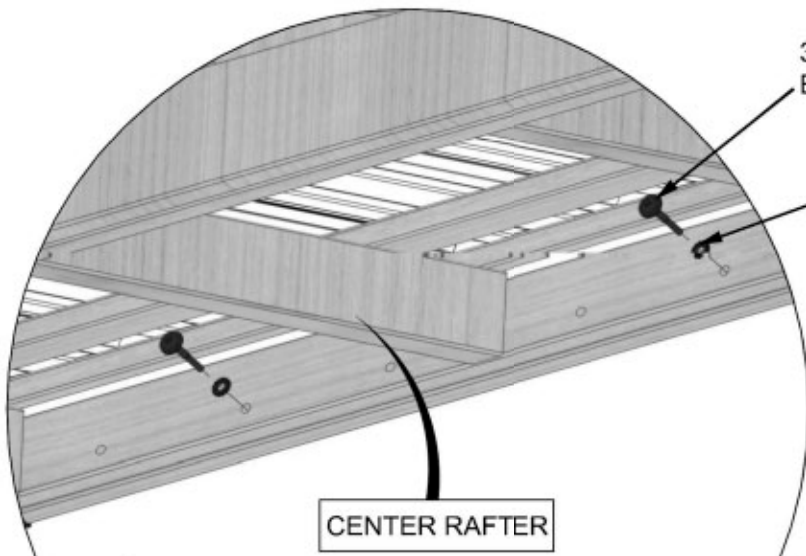

NOTE HARDWARE LOCATION. SKIP FIRST TWO HOLES BY CENTER RAFTER. T-NUTS SHOULD ALREADY BEEN INSTALLED TO BACK SIDE OF ROOF SUPPORT FROM STEP 7. SNUG HARDWARE ONLY, ONCE ALL PANELS ARE INSTALLED ALL HARDWARE WILL THEN BE TIGHTENED.

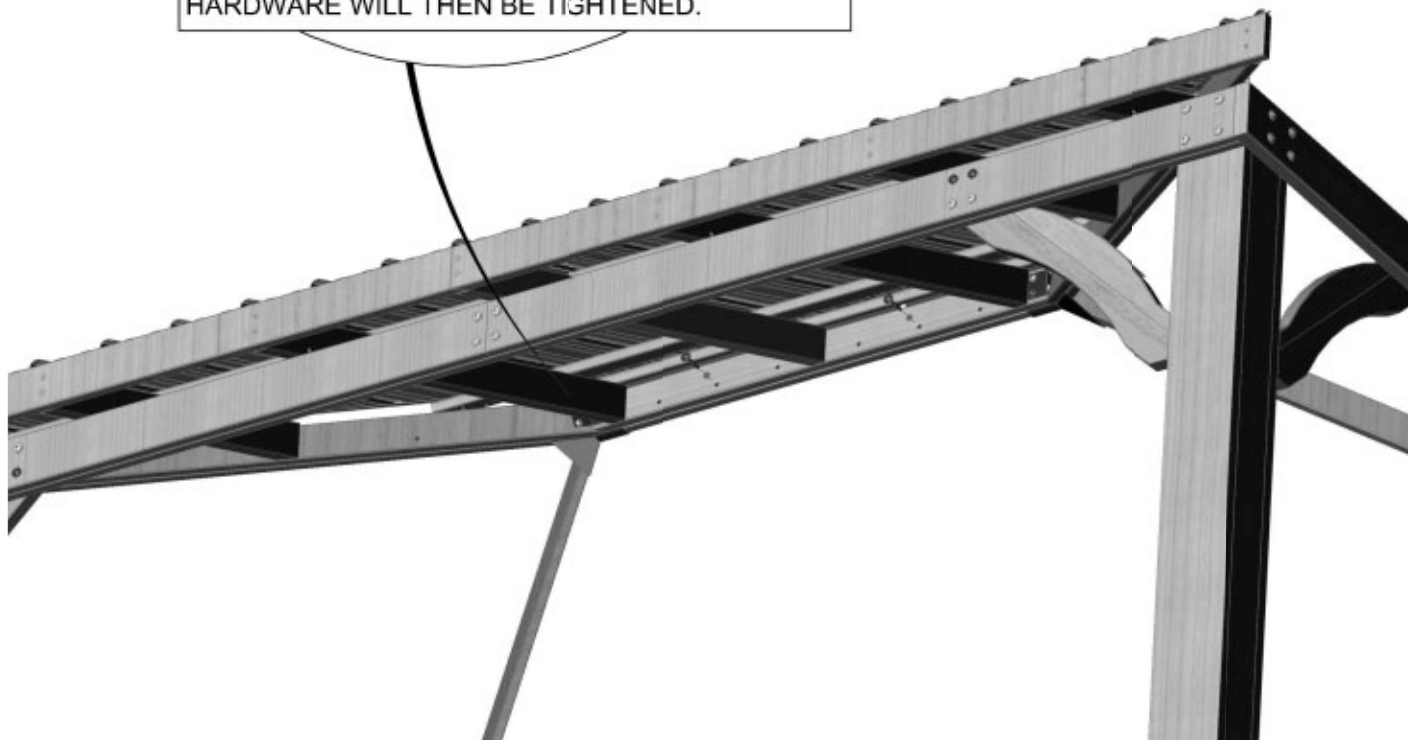
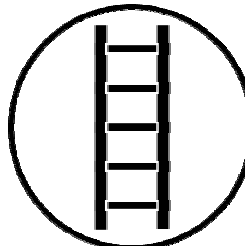



H100379 | T-NUT BLK
(2) | 5/16



**H100198 | WASHER LOCK
EXT BLK**
(6) | 8x19



**H100770 | WASHER FLAT
BLK 5/16**
(x4)



H100378 | BOLT WH BLK
(2) | 5/16x1-3/4



H100415 | BOLT WH BLK
(4) | 5/16x3 3/4



H100479 | NUT LOCK BLK
(x4) | 5/16

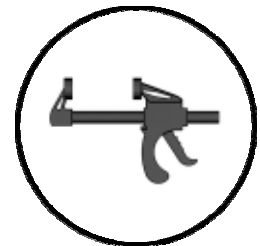
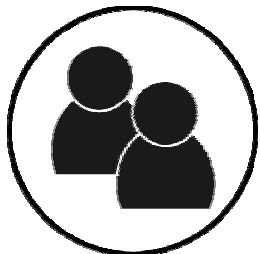
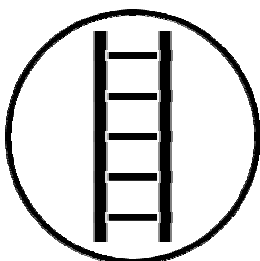

198 (x4)
WASHER - 8x19

415 (x4)
BOLT - 3 3/4"

REPEAT STEP 28 FOR OPPOSITE 14FT
ROOF PANEL ASSEMBLY PLACEMENT.

770 (x4)
WASHER FLAT - 5/16"

479 (x4)
NUT LOCK - 5/16"

198 (x1)
WASHER - 8x19

378 (x1)
BOLT - 1 3/4"

379 (x1)
T-NUT - 5/16"

TIP:
SNUG HARDWARE ONLY, ONCE ALL PANELS
ARE INSTALLED ALL HARDWARE WILL THEN
BE TIGHTENED.

REPEAT ON OPPOSITE END OF PANEL

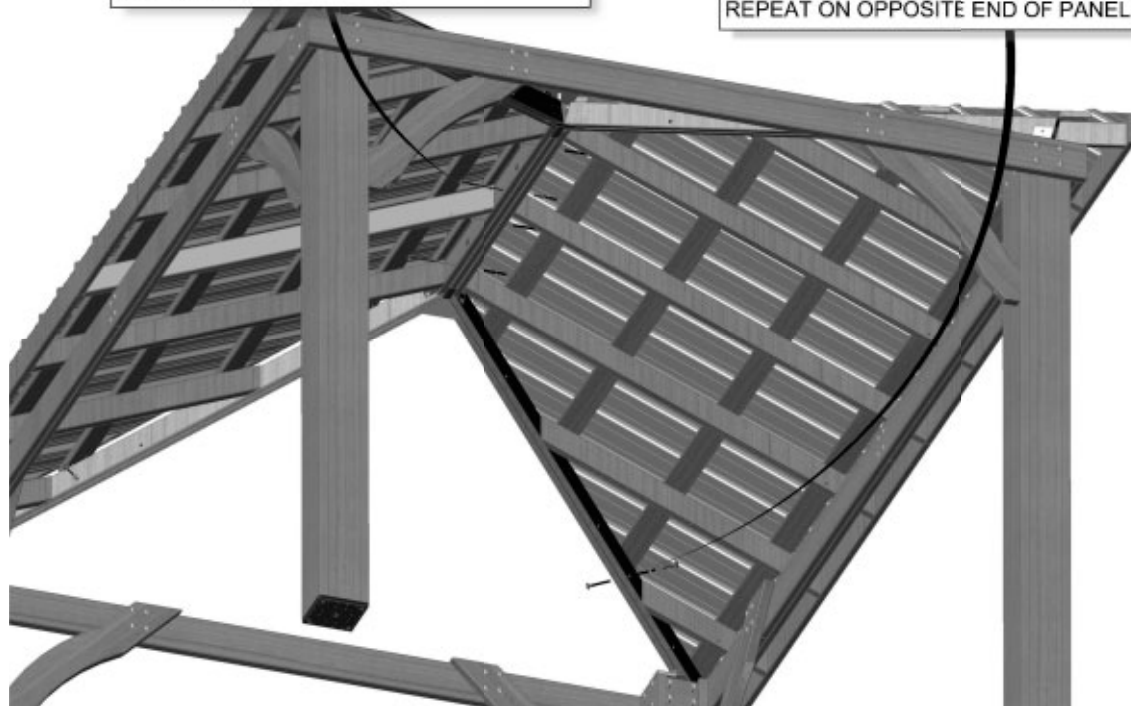

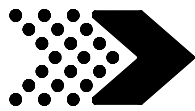

H100378 | BOLT WH BLK
(2) | 5/16x1-3/4



H100379 | T-NUT BLK
(2) | 5/16



H100198 | WASHER LOCK
(2) | EXT BLK
8x19

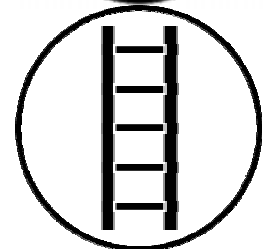
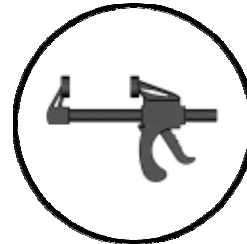
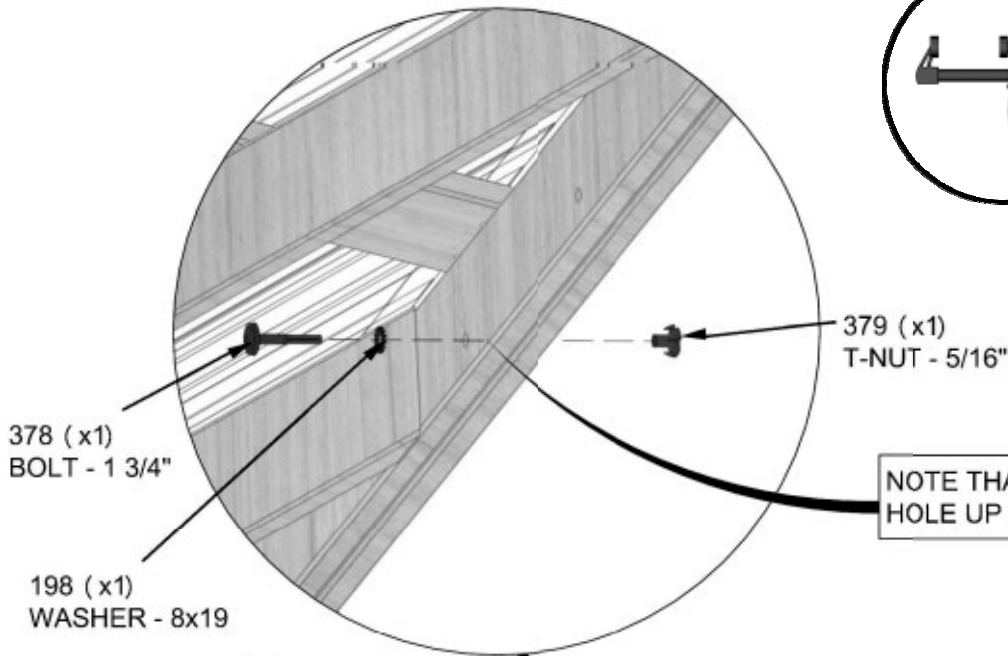

REPEAT ON OPPOSITE END OF PANEL

TIP:
SNUG HARDWARE ONLY, ONCE ALL PANELS ARE INSTALLED ALL HARDWARE WILL THEN BE TIGHTENED.

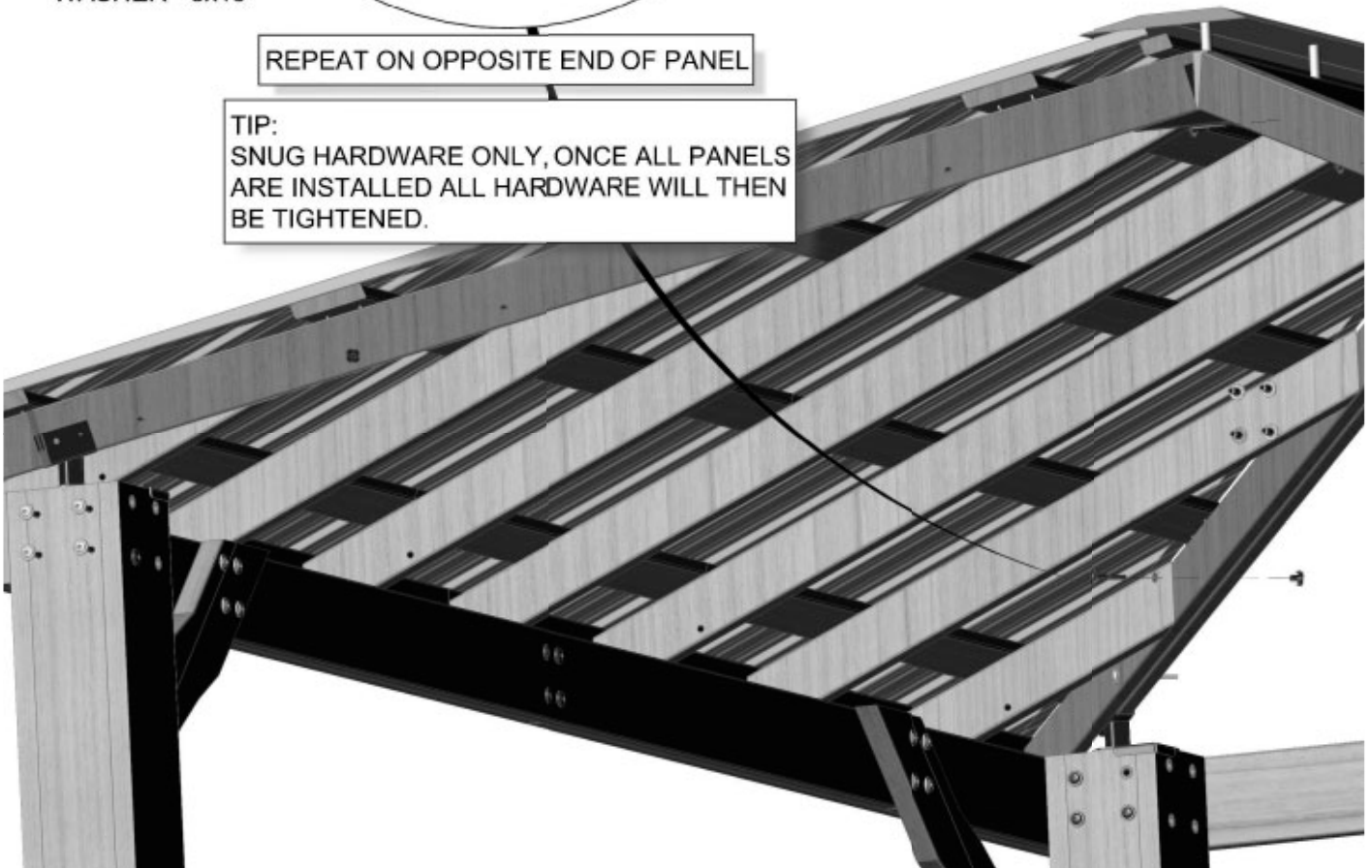



NOTE:

WARNING: GLOVES SHOULD BE WORN WHEN HANDLING ROOF PANELS.

- 1) PLACE LADDER TOWARD THE CENTER OF THE ROOF SUPPORT. IF NEEDED PLACE ANOTHER LADDER ON THE SIDE TO REACH AND HOLD THE BACK OF THE PANEL.
- 2) WITH AT LEAST TWO PEOPLE LIFT 10FT ROOF PANEL AND LAY ON TOP OF THE SIDE SUPPORT.
- 3) CAREFULLY WORK PANEL UP SLOWLY UNTIL IT MEETS WITH PREVIOUS INSTALLED 14FT PANELS. AVOID DRAGGING THE PANEL ACROSS SIDE SUPPORT AS DAMAGE COULD OCCUR TO THE SURFACES. ONCE PANELS AND ROOF SUPPORT HOLES ARE ALIGNED, ATTACH HARDWARE. SEE FOLLOWING STEPS FOR DETAILS.

TIP: A THIRD PERSON PERSON IS SUGGESTED TO HELP SUPPORT THE PANEL OR HANDLE HARDWARE TO ATTACH PANELS.

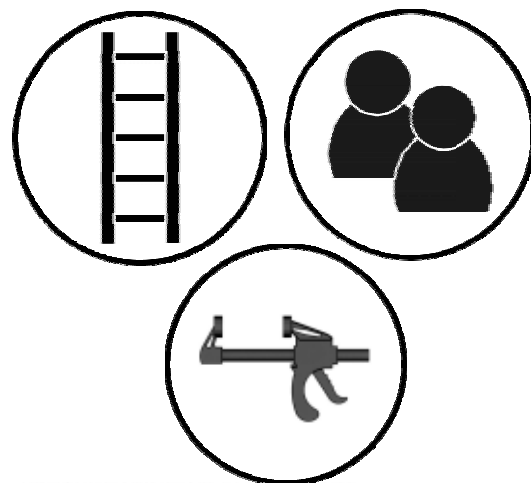

CAREFULLY SLIDE PANEL UNDER RIDGE CAP.

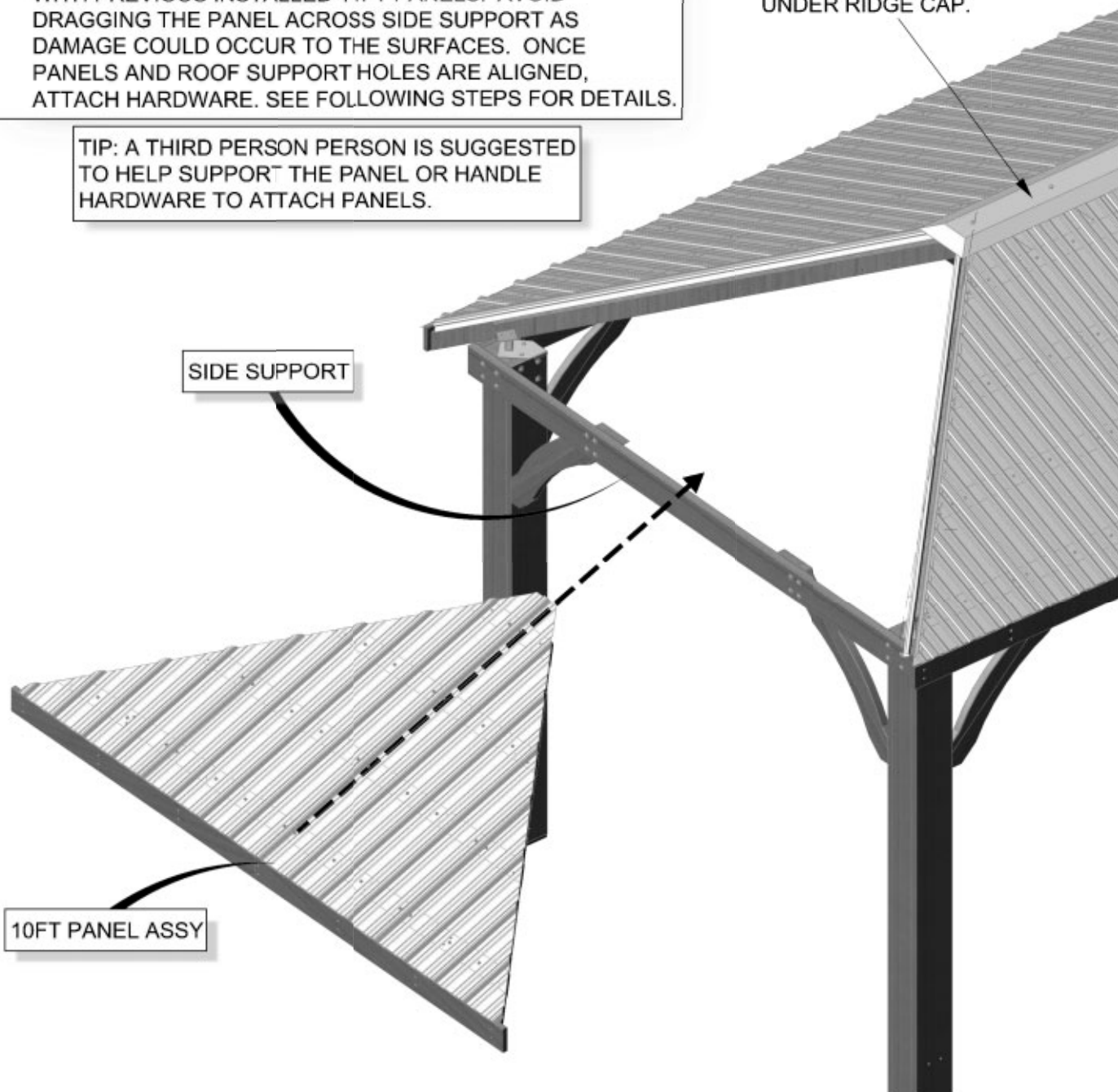

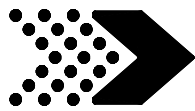

H100479 | NUT LOCK BLK
(x12) | 5/16



H100415 | BOLT WH BLK
(12) | 5/16x3 3/4



H100770 | WASHER FLAT
(12) | BLK
5/16



H100198 | WASHER LOCK
(12) | EXT BLK
8x19

COMPLETE THIS STEP TWICE

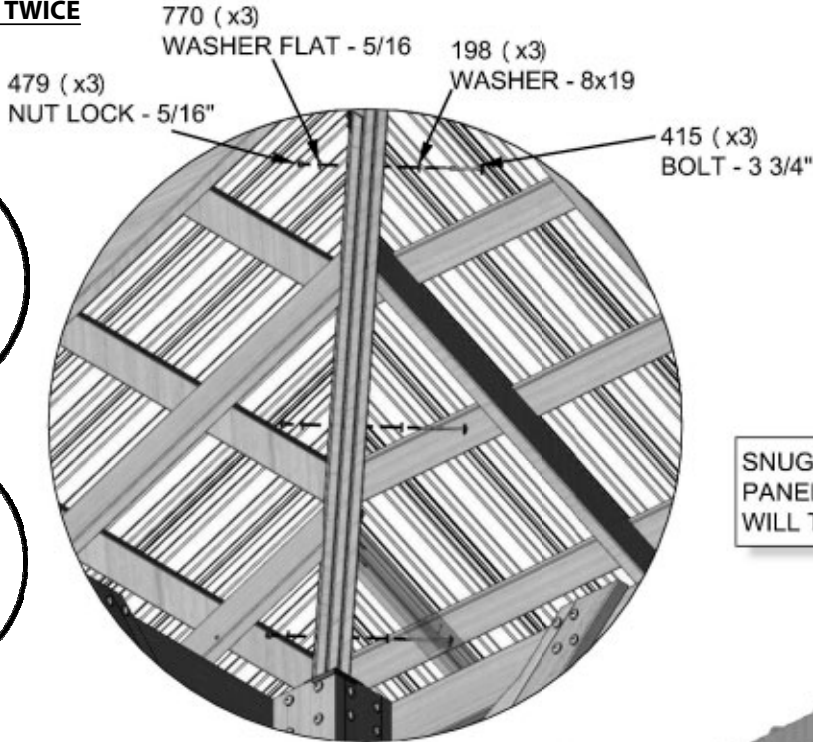
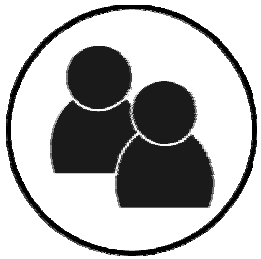
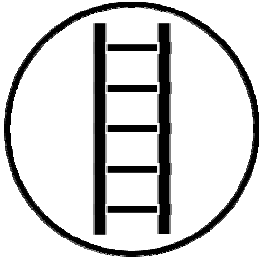

SNUG HARDWARE ONLY, ONCE ALL PANELS ARE INSTALLED ALL HARDWARE WILL THEN BE TIGHTENED.

REPEAT ON OPPOSITE END OF PANEL

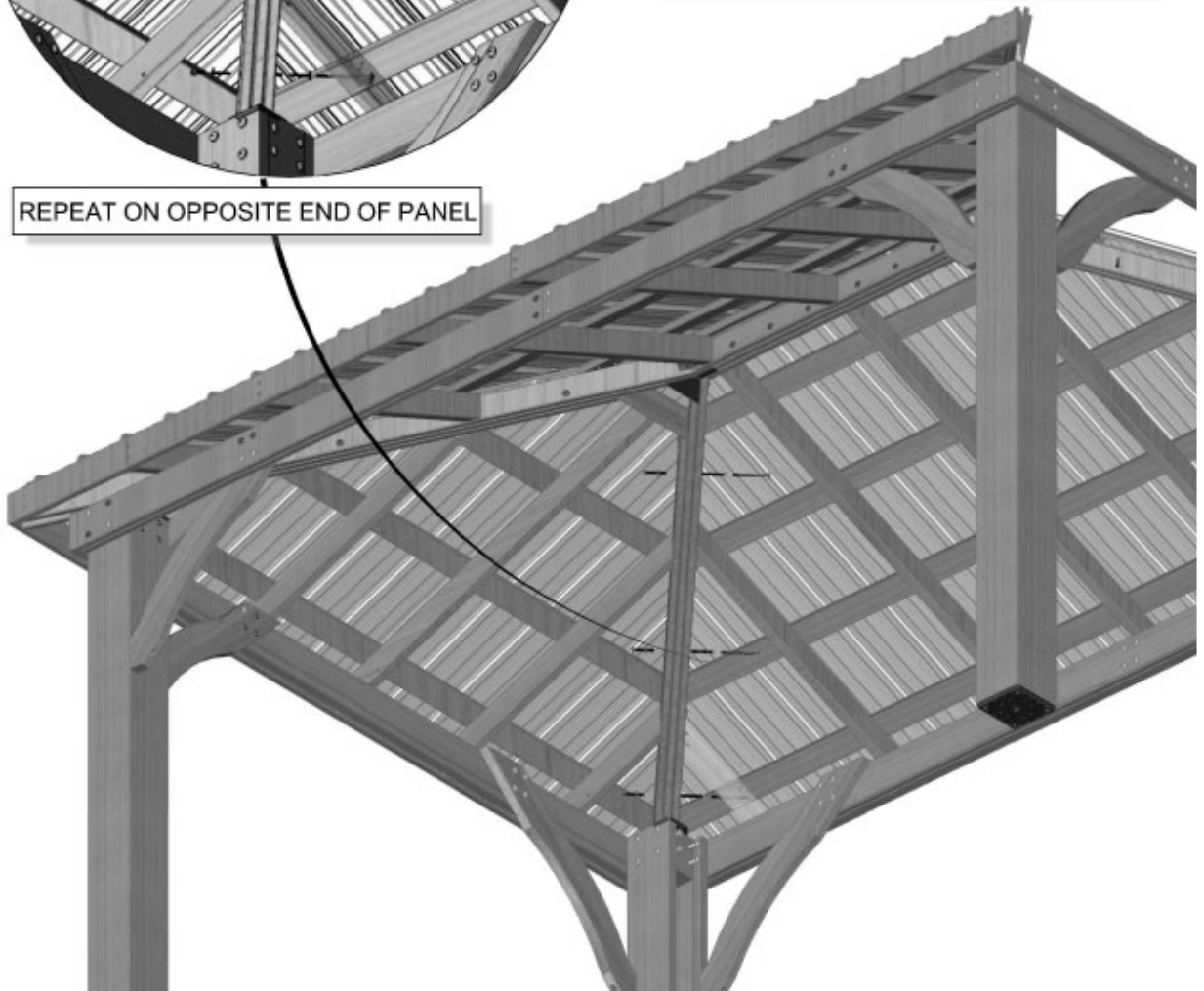

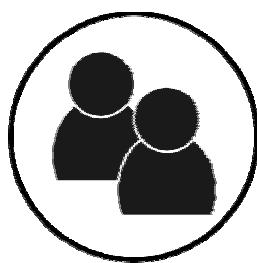
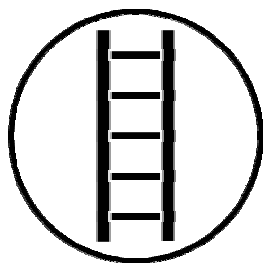

4TH

1ST

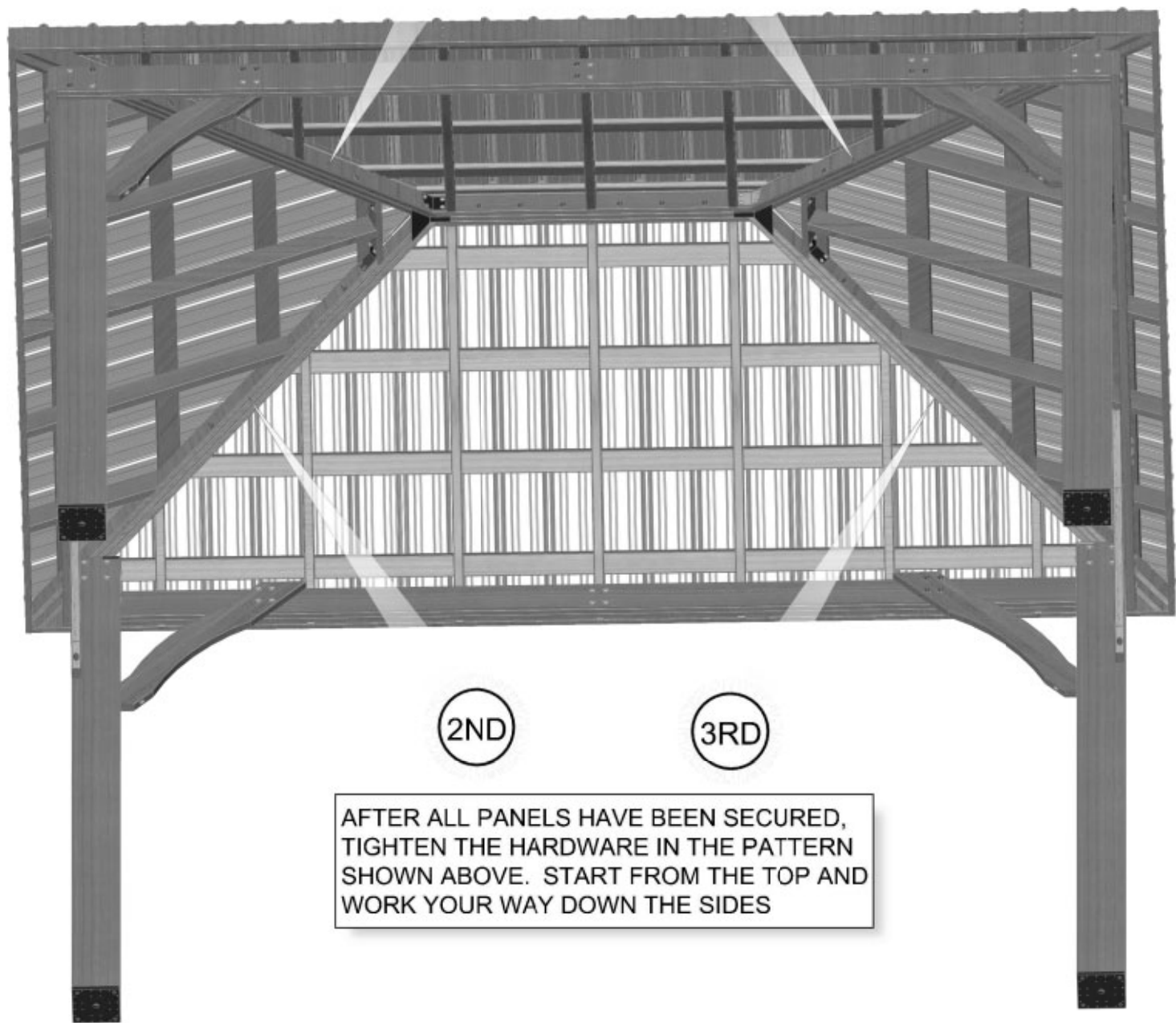

2ND

3RD

AFTER ALL PANELS HAVE BEEN SECURED,
TIGHTEN THE HARDWARE IN THE PATTERN
SHOWN ABOVE. START FROM THE TOP AND
WORK YOUR WAY DOWN THE SIDES

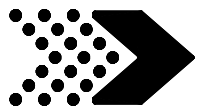

ROOF ASSEMBLY

STEP 34

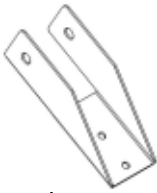

A4M01228 | RAFTER CLIP
(6)



H100630 | WASHER FLAT
(x6) | BLK 8x19



H100653 | NUT LOCK BLK
(x6) | 1/4



H100392 | SCREW PWH BLK
(12) | 8x3/4



H100488 | BOLT WH BLK
(6) | 1/4x2

REPEAT THIS STEP ON BOTH
10FT ROOF PANEL ASSEMBLIES

630 (x3)
WASHER - 8x19

653 (x3)
NUT - 1/4"

488 (x3)
BOLT - 2"

392 (x6)
SCREW - 3/4"

228 (x3)
RAFTER CLIP

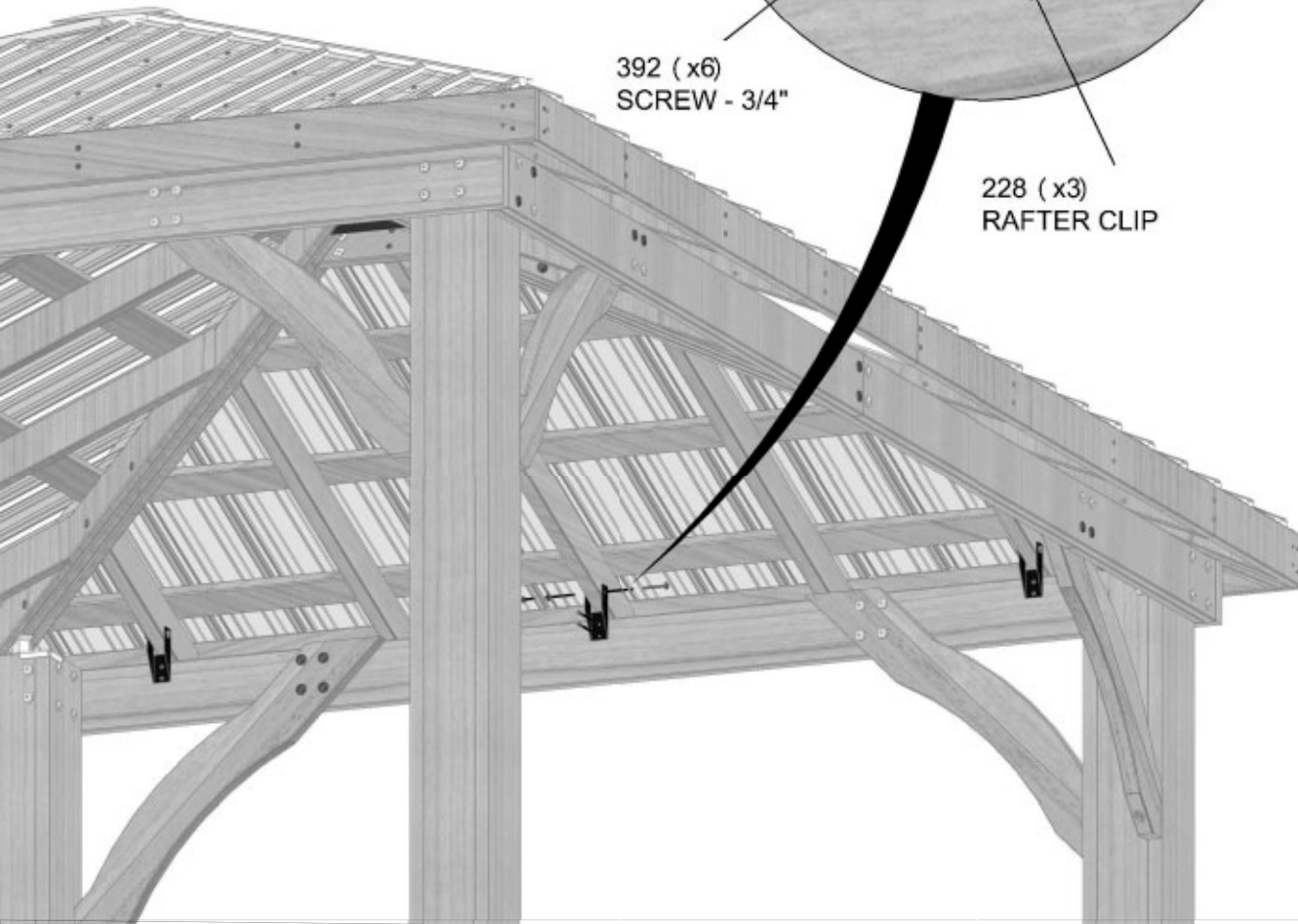

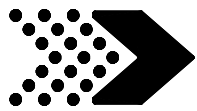

ROOF ASSEMBLY

STEP 35



A4M01228 | RAFTER CLIP
(8)



H100630 | WASHER FLAT
(x8) | BLK 8x19



H100653 | NUT LOCK BLK
(x8) | 1/4



H100392 | SCREW PWH BLK
(16) | 8x3/4



H100488 | BOLT WH BLK
(8) | 1/4x2

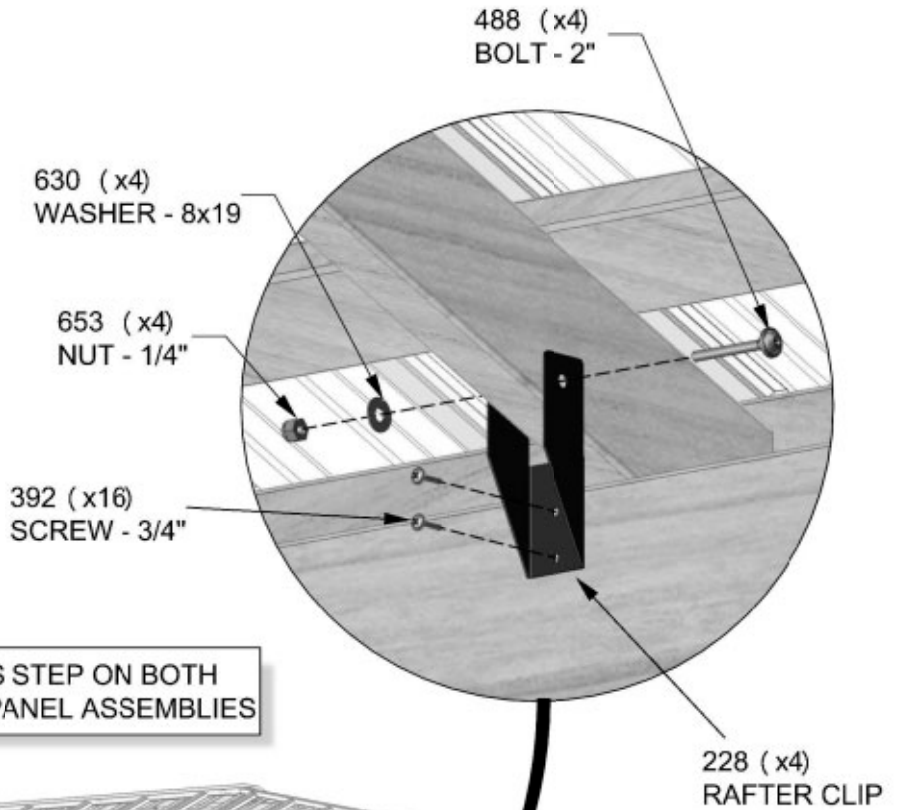

REPEAT THIS STEP ON BOTH
14FT ROOF PANEL ASSEMBLIES

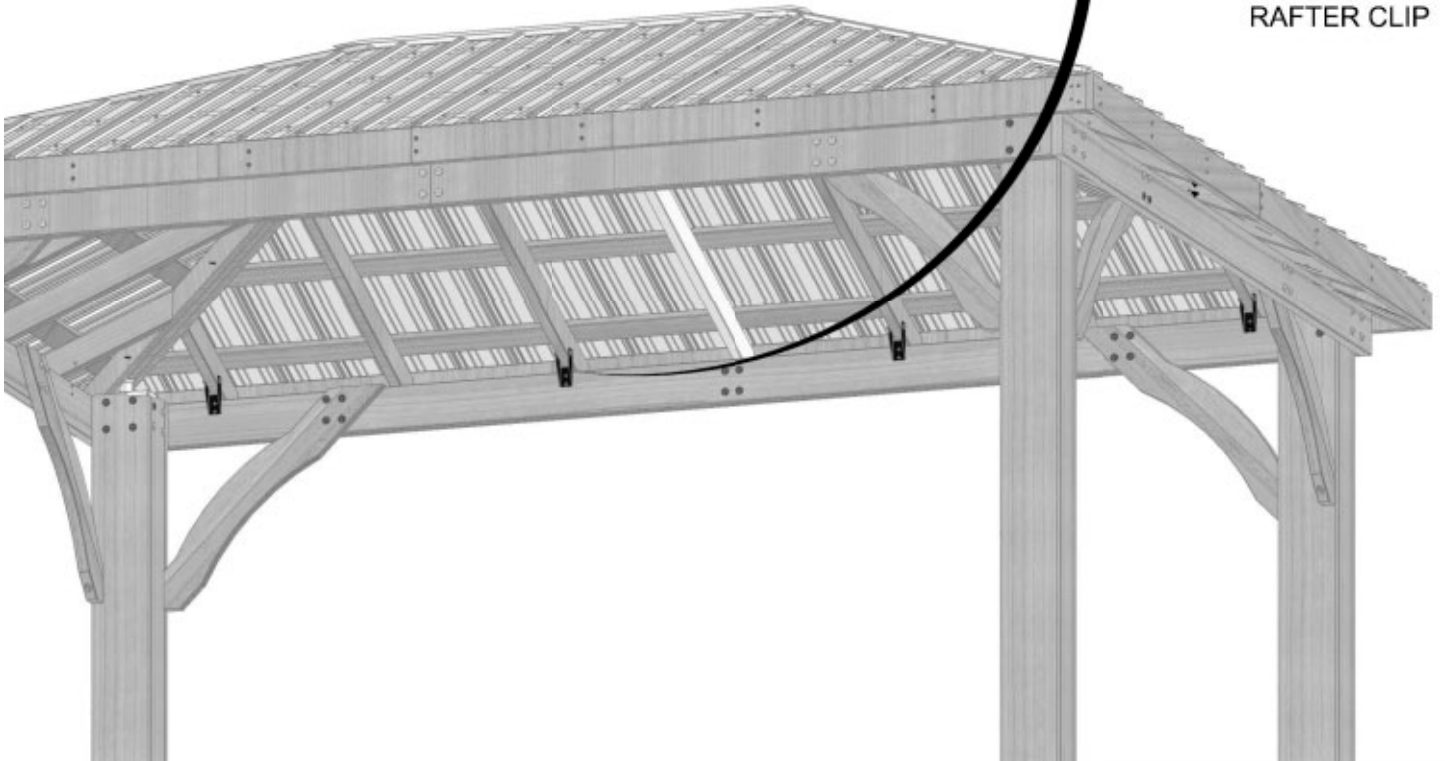

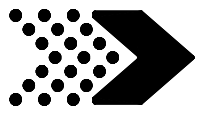

A4M01185 | CORNER BRACKET
(4)



H100392 | SCREW PWH BLK
(16) | 8x3/4

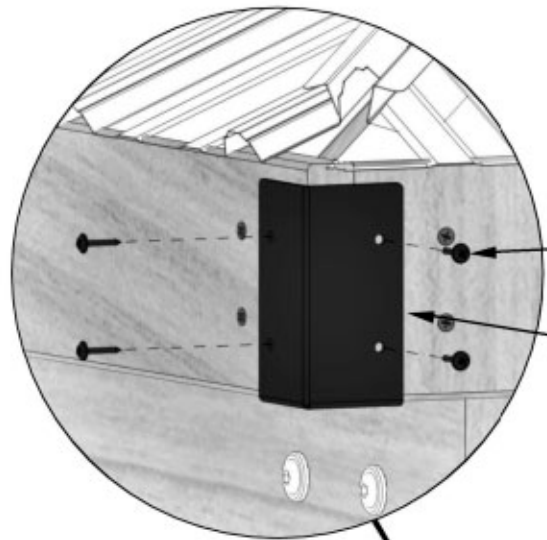

392 (x4)
SCREW - 3/4"

185 (x1)
CORNER BRACKET

REPEAT THIS STEP ON
ALL FOUR CORNERS

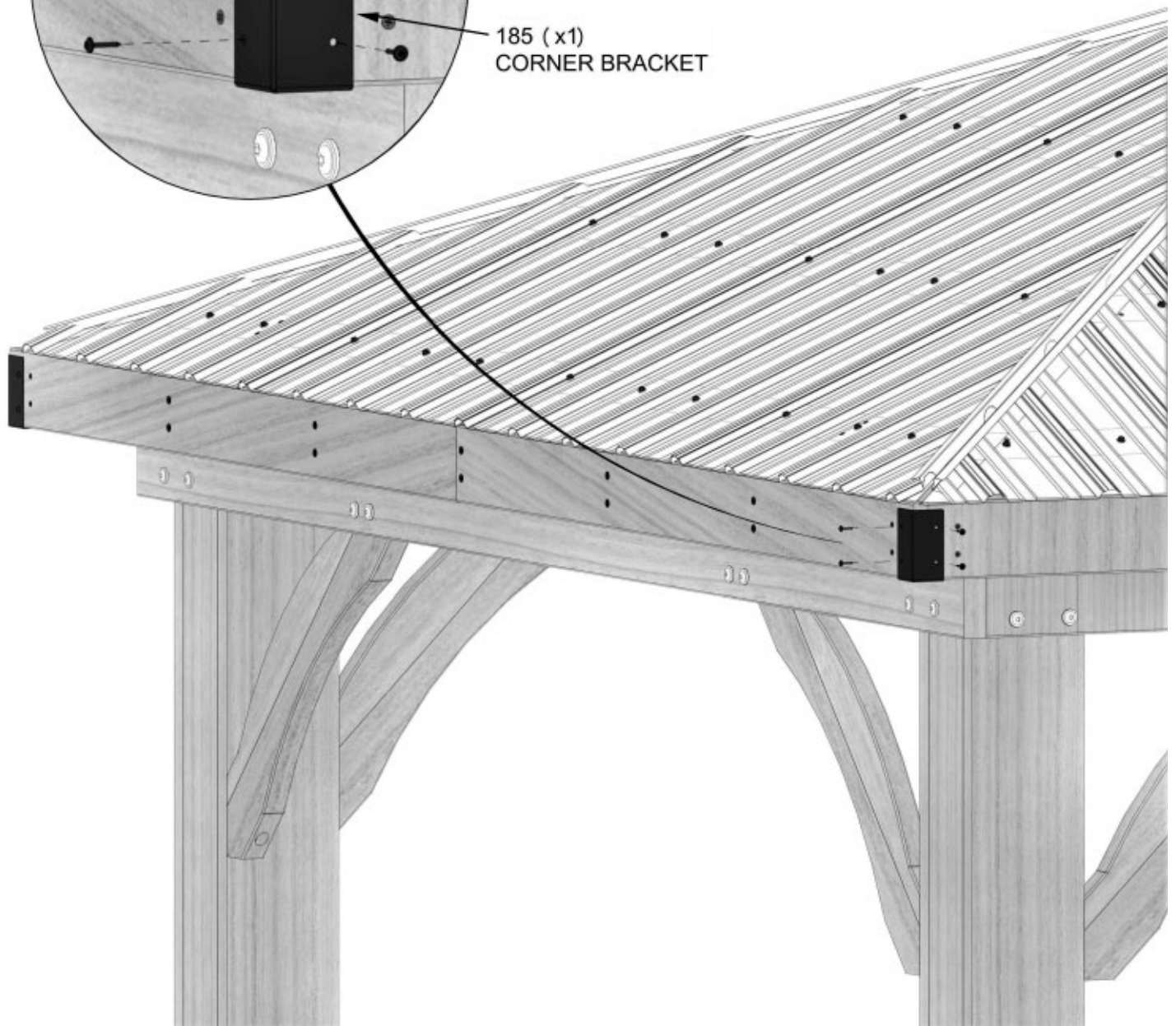



A4M01200 | EDGE TRIM LONG
(4)

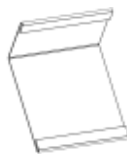

A4M01201 | EDGE TRIM SPLICE
(4)



H100759 | SCREW TAPPING
(32)
1/4x3/4



A4M01203 | EDGE TRIM SHORT
(2)



A4M01202 | EDGE TRIM CORNER SPLICE
(4)

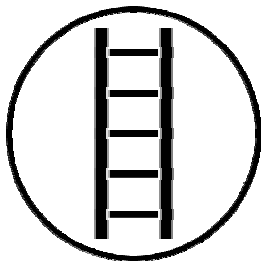

START ON THE LEFT SIDE OF A 14FT PANEL. PLACE EDGE TRIM CORNER SPLICE AND SLIDE LONG EDGE TRIM INTO CORNER SPLICE, INSTALL 759 SCREW AS SHOWN. CONTINUE TO WORK TO THE RIGHT. SEE STEP 38 FOR 10FT EDGE TRIM ASSEMBLY.

START FIRST SCREW AT THIS LOCATION AND ATTACH TO EVERY OTHER HIGH RIDGE ON THE TIN PANELS. ATTACH TWO SCREWS AT EACH SPLICE TO HOLD EACH SECTION OF TRIM.

TIP:
SLIDE ALL EDGE TRIM AND SPLICES TOGETHER BEFORE INSTALLING ALL SCREWS TO ENSURE THAT ALL THE PANEL IS COVERED CORRECTLY. SLIDE EDGE TRIMS IN OR OUT OF SPLICES TO ACHIEVE THIS.

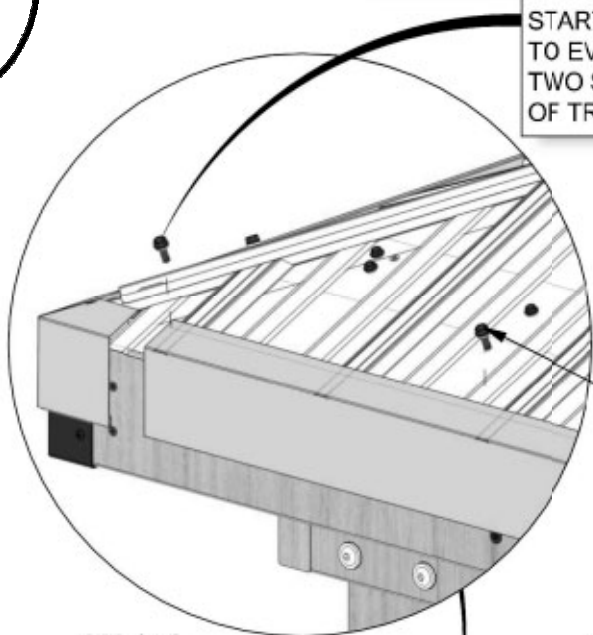

759 (x16)
SCREW - 3/4"

202 (x4)
EDGE TRIM CORNER SPLICE

200 (x2)
EDGE TRIM LONG

201 (x2)
EDGE TRIM SPLICE

203 (x1)
EDGE TRIM SHORT

NOTE: EDGE TRIM "203" IS ONLY USED ON FRONT AND BACK SIDE IN THE MIDDLE.

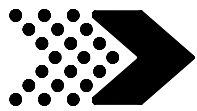

A4M01200 | EDGE TRIM LONG
(4)

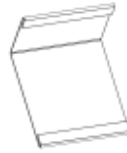

A4M01201 | EDGE TRIM SPLICE
(2)



H100759 | SCREW TAPPING
(20)
1/4x3/4

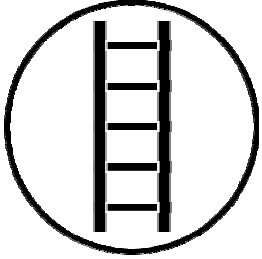

AFTER ADDING TRIM TO 14FT SIDE, INSERT 200 EDGE TRIM INTO THE CORNER TRIM SPLICE. INSTALL 759 SCREW AS SHOWN. CCNTINUE TO WORK TO THE RIGHT.

START FIRST SCREW AT THIS LOCATION AND ATTACH TO EVERY OTHER HIGH RIDGE ON THE TIN PANELS. ATTACH TWO SCREWS AT EACH SPLICE TO HOLD EACH SECTION OF TRIM.

TIP:
SLIDE ALL EDGE TRIM AND SPLICES TOGETHER BEFORE INSTALLING ALL SCREWS TO ENSURE THAT ALL THE PANEL IS COVERED CORRECTLY. SLIDE EDGE TRIMS IN OR OUT OF SPLICES TO ACHIEVE THIS.

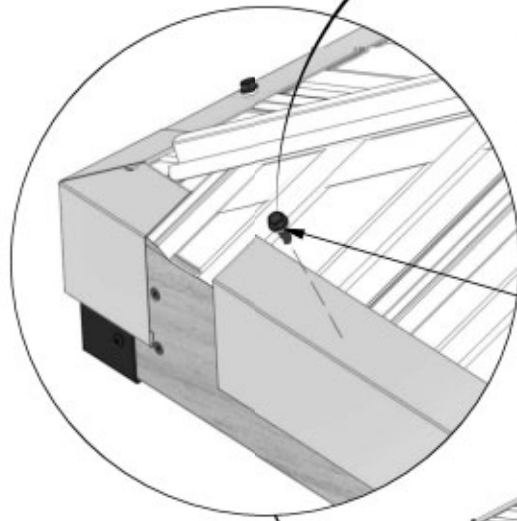

759 (x10)
SCREW-3/4"

200 (x2)
EDGE TRIM LONG

201 (x1)
EDGE TRIM SPLICE

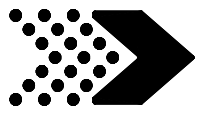

A4M01199 | CORNER RIDGE CAP
(4)



H100759 | SCREW TAPPING
(8) | 1/4x3/4

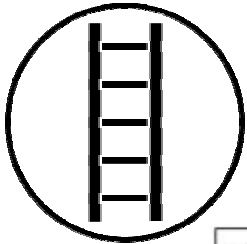

REPEAT THIS STEP ON ALL FOUR CORNERS

INSERT CORNER RIDGE CAP INTO ROFF RIDGE CAP CHANNELS (SEE DETAIL IMAGE) . CAREFULLY SLIDE CORNER RIDGE CAP UP UNTIL IT REACHES THE TOP. FASTEN AS SHOWN.

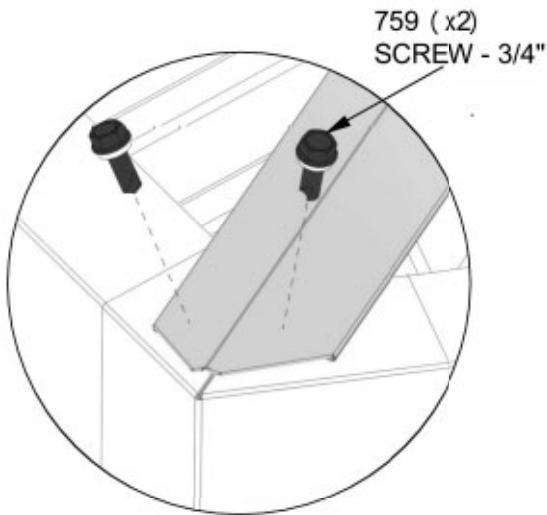
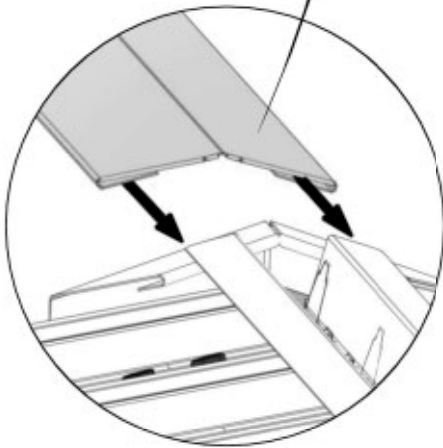

759 (x2)
SCREW - 3/4"

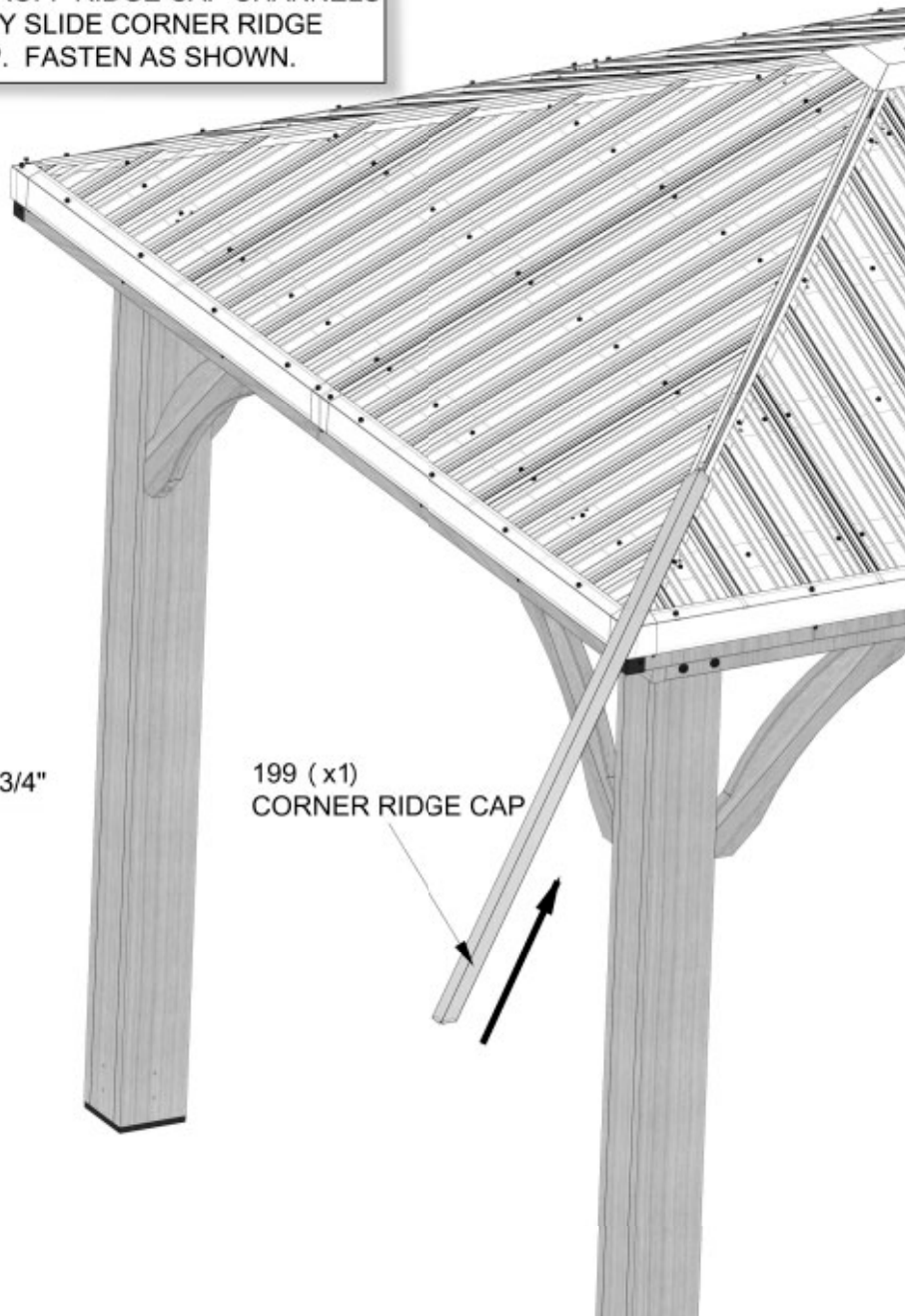

199 (x1)
CORNER RIDGE CAP

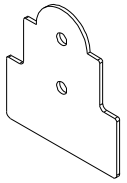
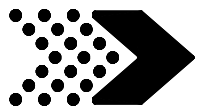

A4M00950
(8) | **STEEL POST PLATE**

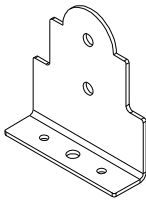

A4M00949
(8) | **STEEL POST ANCHORING PLATE WITH FLANGE**



H100471
(32) | **LAG SCREW**
WH BLK
5/16x1 1/2

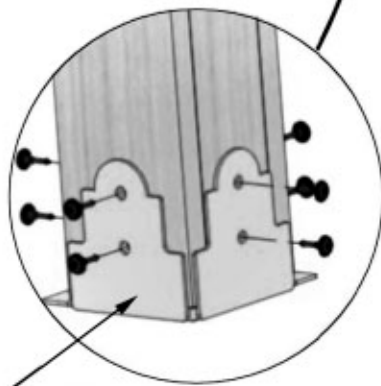
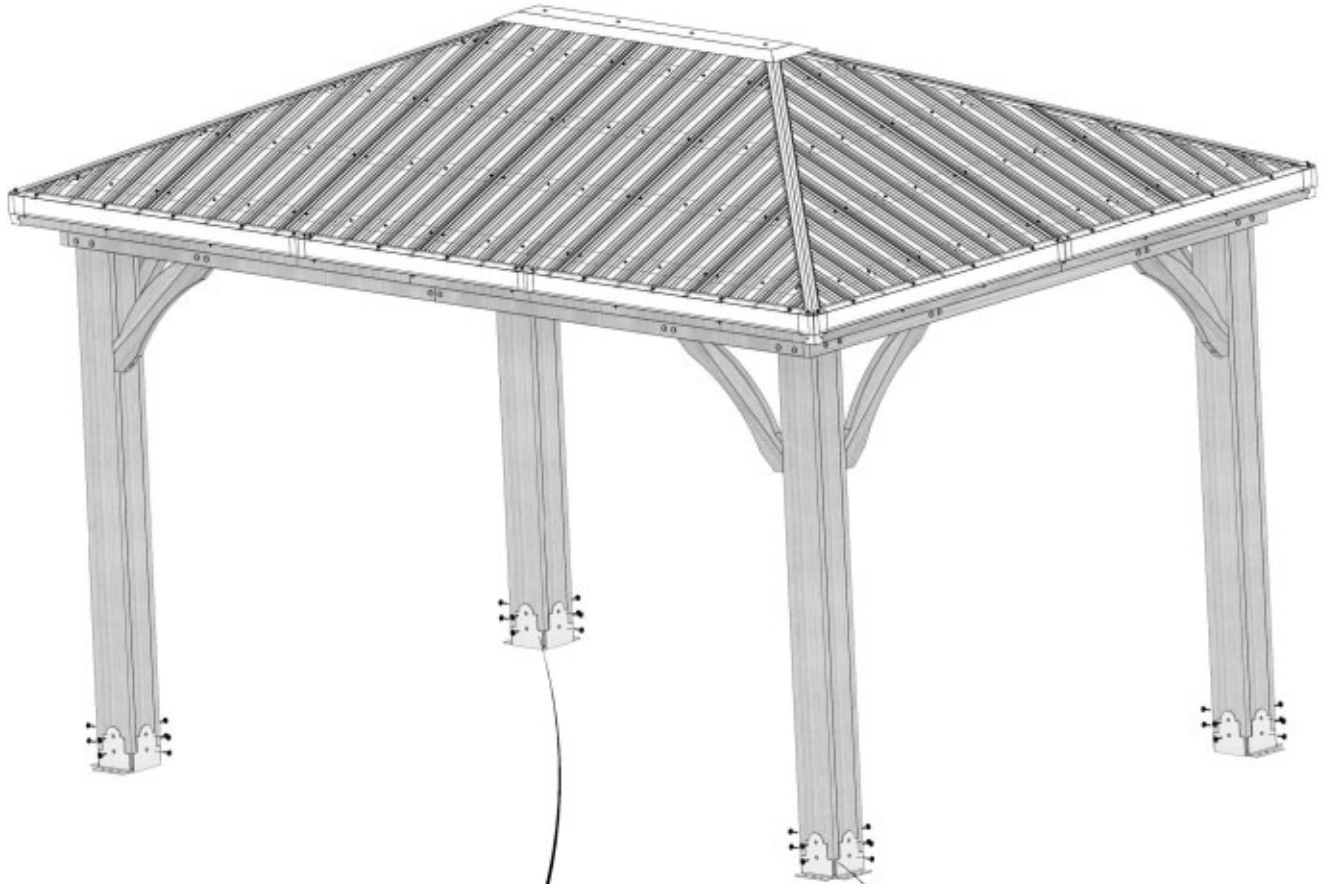

950 (x8)
STEEL POST PLATE

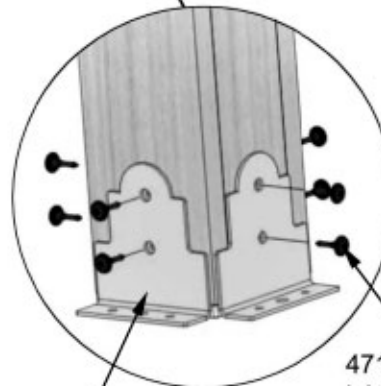

471 (x32)
LAG SCREW - 1 1/2"

949 (x8)
STEEL POST ANCHORING PLATE

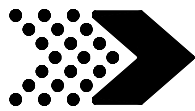

A100241 | **BYD ID TAG**
(1) | **(SMALL)**
WITHOUT AGES



A100314 | **"A" REVISION TAG**
(1)



H100200 | **SCREW PFH BLK**
(4) | **3x1-1/2**

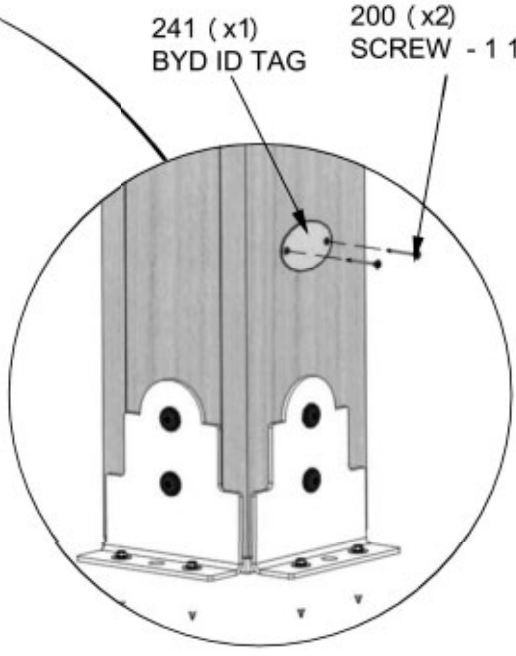
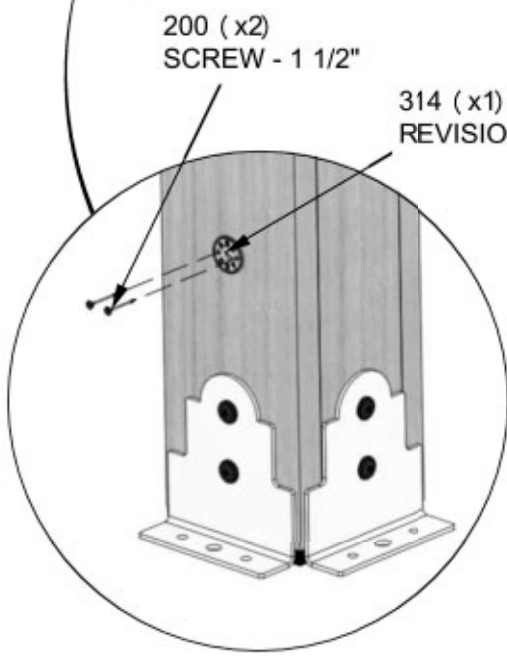
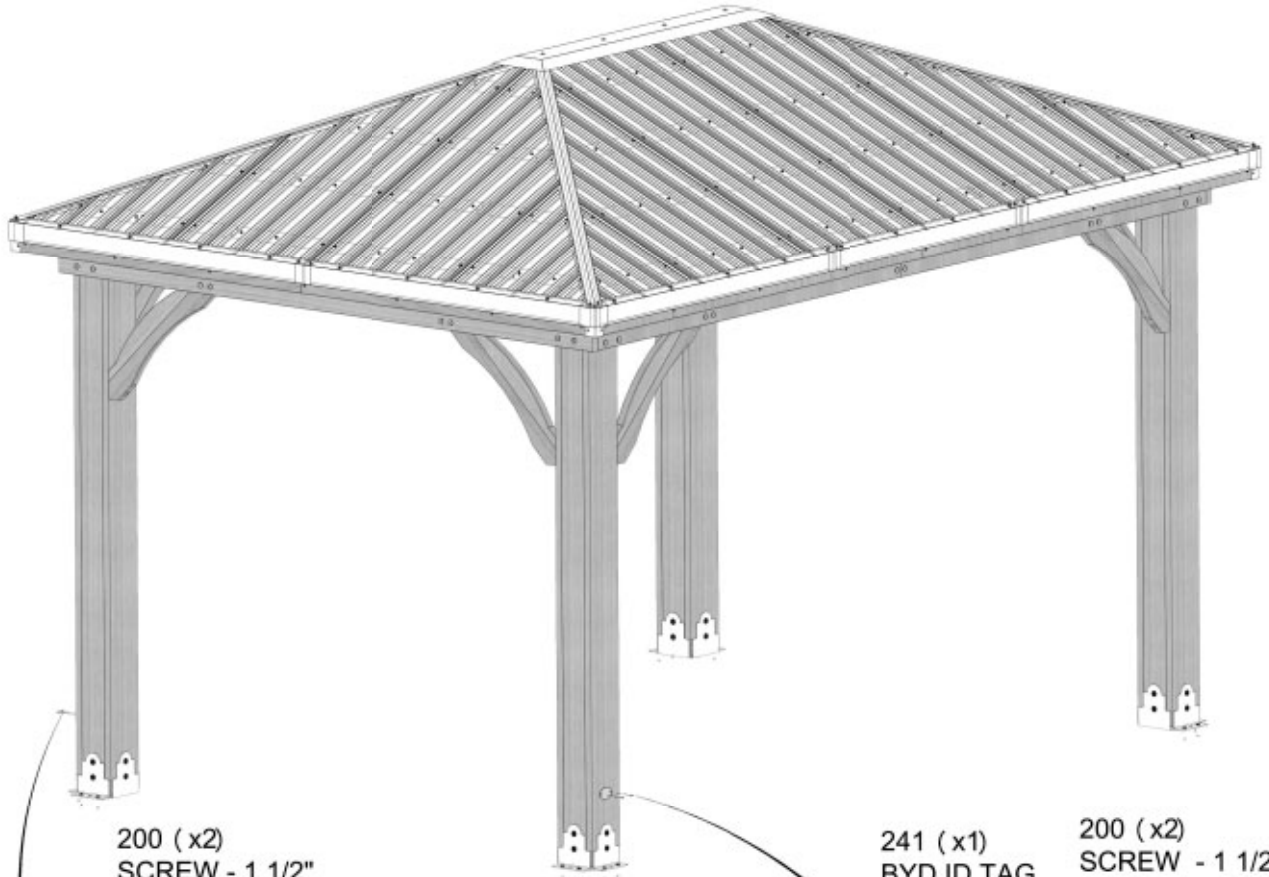



H100120 | SCREW CONCRETE ANCHOR
(16) | 1/4x2



H100630 | WASHER FLAT
(16) | **BLK**
8x19

NOTE:
MANUFACTURER RECOMMENDS INSTALLATION ON CONCRETE SURFACE OR CONCRETE POST PADS. SEE BELOW.

FOR INSTALLATION ON A WOOD DECK, YOU MUST ENSURE THERE IS AMPLE STRUCTURAL SUPPORT UNDER DECK. SCREWS ARE NOT PROVIDED TO ATTACH TO A DECK.

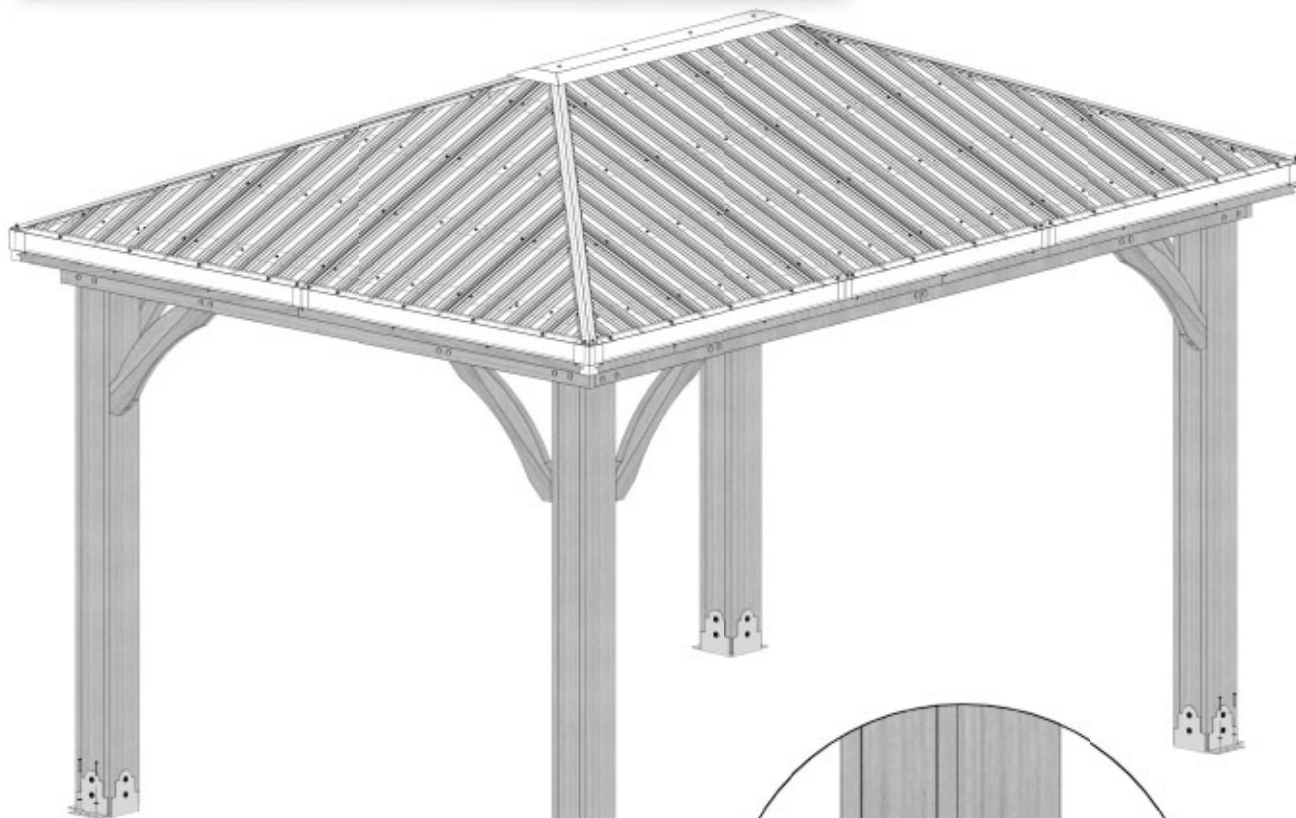

120 (x16)
SCREW - 2"

630 (x16)
WASHER - 8x19

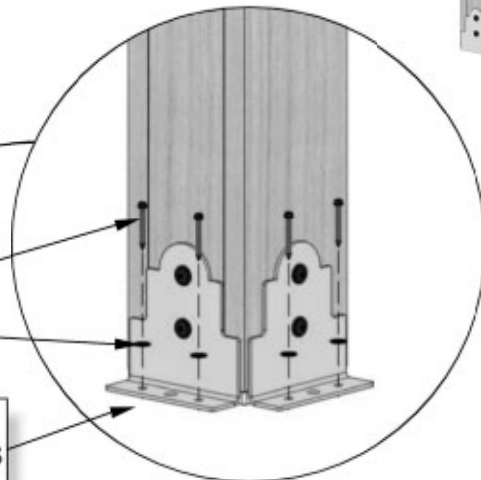

NOTE:
PRE-DRILL HOLES FOR CONCRETE ANCHORS USING A 3/16" CONCRETE DRILL BIT.

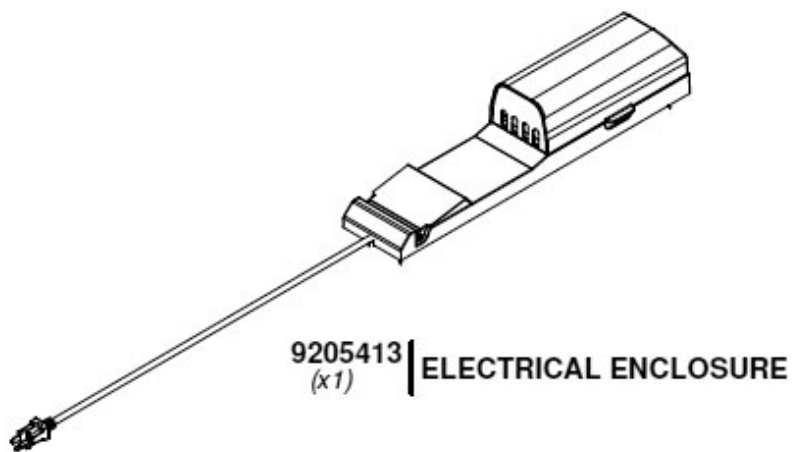

FOR ELECTRICAL ENCLOSURE INSTALLATION REFER TO ASSEMBLY INSTRUCTIONS THAT COMES PACKAGED WITH THE ELECTRICAL ENCLOSURE KIT. INSTALL ON ANY POST THAT IS DESIRED. FOLLOW DIRECTIONS FOR PROPER INSTALLATION.