



SNUGRIDE® 30/SNUGRIDE® 30 LX INFANT CAR SEAT

Read This Instruction Manual

Do not install or use this child restraint until you read and understand the instructions in this manual.

**FAILURE TO PROPERLY
USE THIS
CHILD RESTRAINT
INCREASES THE
RISK OF SERIOUS
INJURY OR DEATH IN
A SUDDEN STOP OR
CRASH.**

**KEEP INSTRUCTIONS
FOR FUTURE USE.**

www.gracobaby.com

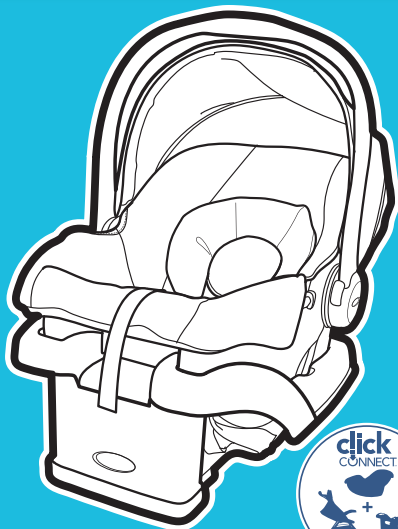

PD284962H 4/20

Important

Pages 4-13

- 1-A Quick Guide to Your Manual**
- 1-B Before You Begin**
- 1-C Safety Warnings**

Features

Pages 14-23

- 2-A Car Seat Features**
- 2-B Remove Car Seat from Base**
- 2-C Attach Car Seat to Base**
- 2-D Adjusting Carry Handle**
- 2-E Recline the Base**
- 2-F Choosing Vehicle Seat Location**
- 2-G Choosing LATCH or Seat Belt**
- 2-H What Is LATCH**

Rear-Facing Use

Pages 24-42

- 3-A Rear-Facing Checklist**
- 3-B Install With Base With LATCH Strap**
- 3-C Install With Base With Vehicle Seat Belt**
- 3-D Install Without Base With Vehicle Seat Belt**

Securing Child

Pages 43-54

- 4-A Adjust Harness to Fit Child**
- 4-B Adjust Buckle to Fit Child**
- 4-C Securing Child in Car Seat**
- 4-D Removing Child**

Carrier Use

Pages 55-56

Vehicle Information

Pages 57-67

- 6-A Additional LATCH Information**
- 6-B How to Remove LATCH**
- 6-C Unsafe Vehicle Seats**
- 6-D Vehicle Seat Belts**

Accessories

Page 68

Care & Cleaning

Pages 69-75

- 8-A Cleaning Seat Pad**
- 8-B Cleaning Buckle**
- 8-C Cleaning LATCH**



1 Important

1-A Quick Guide to Your Manual

This car seat is for children 4-30 lb (1.8-14 kg) and 30" (76 cm) or less.

Get to Know Your Car Seat

Review section 2-A to see all of the features of this infant car seat.

What Seating Location Should I Use?

The best seating location for this infant car seat is one that:

- Is recommended by your vehicle owner's manual, and
- Results in a secure installation of this car seat.



Never place a child rear-facing in a seating position with an active front air bag.

Review section 6 of this manual AND your vehicle owner's manual.

Which Installation Method Should I Use?

This infant car seat base can be installed in your vehicle using either the vehicle seat belt **OR** the LATCH system. Both are equally safe to use. **DO NOT USE BOTH AT THE SAME TIME.**

This infant car seat carrier can be installed in your vehicle using only the vehicle seat belt. LATCH is not available to install the carrier.

When Installing Base

LATCH System



LATCH consists of lower anchors, which are built-in to your vehicle, and connecting hooks that are built-in your car seat.

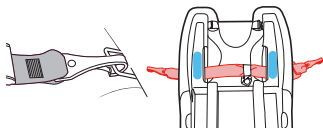

Review section 3-B of this manual AND your vehicle owner's manual.

Vehicle Seat Belt



There are two types of vehicle seat belts that can be used. Lap/Shoulder Seat Belt or Lap Only Seat Belt.

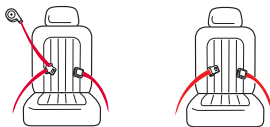

Review section 3-C of this manual AND your vehicle owner's manual.

When Installing Carrier

Vehicle Seat Belt



There are two types of vehicle seat belts that can be used. Lap/Shoulder Seat Belt or Lap Only Seat Belt.

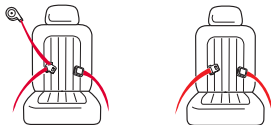

Review section 3-D of this manual AND your vehicle owner's manual.



1 Important

Does Your Seat Fit Your Child Correctly?

To make sure your child is secured properly, review section 4 to understand all of the actions you need to take to properly adjust the car seat to fit your child.

You Need To Adjust:

Harness Height

Harness straps at or just below the child's shoulders. Review section 4-A.



Buckle Position

The correct slot is the one that is closest to your child without being underneath them. Review section 4-B.

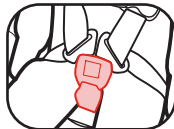

Harness Tightness

If your fingers slide off the harness straps without pinching the straps, it is tight enough. Review section 4-C.



Did You Do Everything Correctly?



1 Important

Base or Car Seat Does Not Move More Than 1" (2.5 cm) At The Belt Path

Review section 3.



Car Seat Level to Ground

Review sections 2-E and 3.

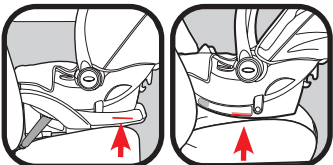

Car Seat Is Properly Attached To Base

Review section 2-C.

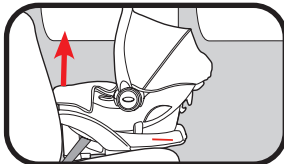

Cannot Pinch Harness

Harness straps at or just below the child's shoulders.

Review section 4-C.

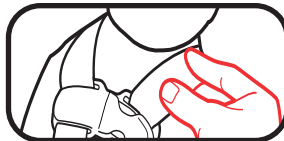

Chest Clip Even With Armpits

Review section 4-C.

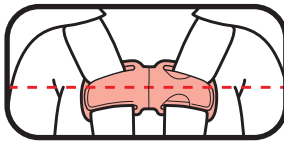



1 Important

1-B Before You Begin

Your child's safety depends on you. No car seat can guarantee protection from injury in every situation, but proper use helps reduce the risk of serious injury or death.

Even if this car seat seems easy to figure out on your own, you must follow the detailed instructions in this instruction manual to ensure the steps below are performed correctly.

Register This Child Restraint

Please fill out the prepaid registration postcard attached to the harness and mail it in today **or register online at www.gracobaby.com/carseatregistration**.

Child restraints could be recalled for safety reasons. You must register this restraint to be reached in a recall. Send your name, address, and the restraint's model number and manufacturing date to:

Graco Children's Products, Inc.
Attn: Customer Service
P.O. Box 169, Elverson, PA 19520-9901
or call 1-800-345-4109
or register online at
www.gracobaby.com/carseatregistration

For recall information, call the U.S. Government's Vehicle Safety Hotline at 1-888-327-4236 (TTY: 1-800-424-9153), or go to <http://www.NHTSA.gov>.



1 Important

For future reference or if you change addresses, record the model name, model number, date of manufacture, and purchase date of this car seat below. You can find this information either on the registration card if you still have it or on the date label located on the back of the car seat.

Model Name _____

Model Number _____

Date of Manufacture _____

Date of Purchase _____

If You Need Help

In the U.S.A, please contact our Customer Service Department with any questions you may have concerning parts, use, or maintenance. When you contact us, please have your product's model number and date of manufacture ready so that we may help you efficiently. These numbers can be found on a sticker on the back side of your car seat.

For additional resources or to get your car seat checked by a child passenger safety technician, please visit the following web sites:

www.nhtsa.gov • www.seatcheck.org • www.safekids.org



1 Important

Certification

This child restraint meets or exceeds all applicable requirements of Federal Motor Vehicle Safety Standard 213 for use in motor vehicles.



This child restraint is certified for use in aircraft when used without the base. Use only on forward-facing aircraft seats. Follow the instructions for vehicle installation. See sections 3-D and 6-D Lap Belt Installation. Contact the airline for their specific policies.

Car Seat's Useful Life

STOP using this car seat and throw it away 7 years after the date of manufacture. Look for date of manufacture label on back of the car seat.

Graco Children's Products Inc. advises against loaning or passing along a car seat unless you know the complete history of the product. We also advise against purchasing a car seat second hand.

Vehicle Seat Protection

Protect vehicle seat. Use a car seat mat, towel, or thin blanket under and behind car seat.

Warm Weather Use

Car seat parts can get very hot in the sun or warm weather. **To avoid burns, always check before putting child in car seat.**

1-C Safety Warnings

No car seat can guarantee protection from injury in every situation, but proper use helps reduce the risk of serious injury or death.

READ THIS MANUAL CAREFULLY.

! WARNING!

Failure to follow these instructions and child restraint's labels can result in child striking the vehicle's interior during a sudden stop or crash.



! NEVER PLACE THIS CHILD RESTRAINT REAR-FACING IN A VEHICLE SEATING LOCATION THAT HAS AN ACTIVE FRONT AIR BAG.

If an air bag inflates, it can hit the child and car seat with great force and cause serious injury or death to your child.

! Review your vehicle owner's manual for more information about air bags and car seat use.

Note: Preterm or low birth weight infants may be at special risk in a vehicle or aircraft. According to the AAP, these infants may suffer breathing issues if improperly reclined in a car seat. Use the corrected age for preemies. Graco advises that you have your physician or hospital staff evaluate your infant and recommend the proper car seat or car bed before you and your infant leave the hospital.



1 Important



1 Important

! If your vehicle does not have a back seat, review your vehicle owner's manual.

! Children are safer riding rear-facing and should ride rear-facing as long as possible, until they reach the maximum rear-facing height or weight rating for their car seat. Graco convertible and all-in-one car seats have higher rear-facing limits that will allow children to ride rear-facing longer after outgrowing their infant car seat. Be sure to check your local and state laws, as well as AAP and NHTSA recommendations, for car seat usage.*

! This child restraint must only be used with children weighing between 4-30 lb (1.8-14 kg).

! Select a suitable location for the car seat in your vehicle.

! Secure car seat with a vehicle seat belt or LATCH that is properly routed as shown in this manual.

! Vehicle seat belt system MUST hold car seat securely. Not all vehicle seat belts can be used with a car seat.

! If vehicle seat belt does not hold car seat securely, read "Vehicle Seat Belts" section 6 and your vehicle owner's manual.

*Graco Supports the American Academy of Pediatrics and National Highway Traffic Safety Administration's Car Seat Guidelines. Visit www.gracobaby.com/en-US/safety for information on car seat usage recommendations.



! Always secure car seat with LATCH or a vehicle seat belt, even when unoccupied. In a crash, an unsecured car seat can injure passengers.

! DO NOT use car seat if it is damaged or missing parts.

! If car seat is in a crash, it must be replaced. DO NOT use it again! A crash can cause unseen damage and using it again could result in serious injury or death.

! DO NOT use accessories or parts other than those provided by Graco except for a thin towel or mat to protect your vehicle seat or rolled towels or pool noodles to help get your car seat level. Their use could alter the performance of the car seat.

! DO NOT remove LATCH system from car seat. If using vehicle seat belt to secure car seat, LATCH connectors must be stored.

! Never leave child unattended, even when sleeping. Child may become tangled in harness straps and suffocate or strangle.

! Rear-facing car seat must be properly leveled:

- Too reclined can result in injury or ejection.
- Too upright can result in breathing difficulties.



! Never attach two LATCH connectors to one vehicle lower anchor point unless specifically allowed by the vehicle manufacturer.

! Do not use both the vehicle seat belt and LATCH strap at the same time when using the car seat rear-facing.

2-A Car Seat Features

2 Features

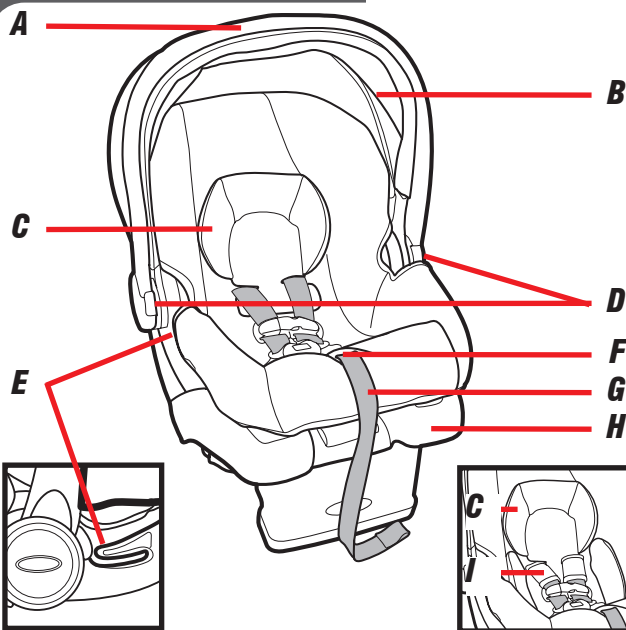

- A Carry Handle**
- B Canopy** (Select models)
- C Head Support** (Select models)
- D Handle Adjustment Buttons**
- E Rear-Facing Belt Path**
(When Used Without Base)

- F Harness Release Lever** (Under Pad)
- G Harness Adjustment Strap**
- H Removable Base**
- I Harness Covers**
(Select Models)

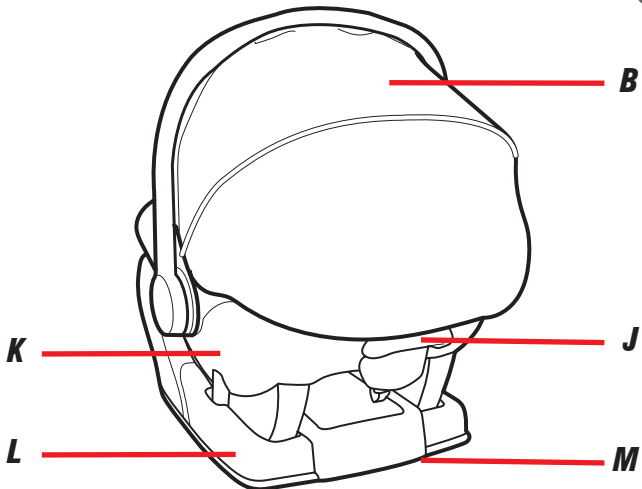

- J** Base Release Lever
- K** Car Seat
- L** Level to Ground Line
- M** Instruction Manual Storage (Under Base)
- N** Chest Clip
- O** Harness Straps
- P** Buckle Tongues
- Q** Buckle
- R** Buckle Strap

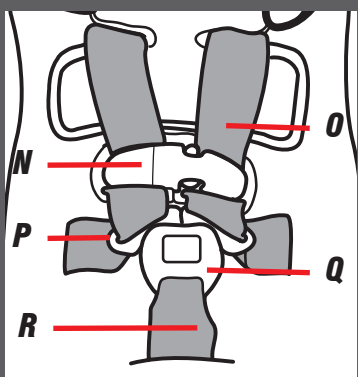

2 Features

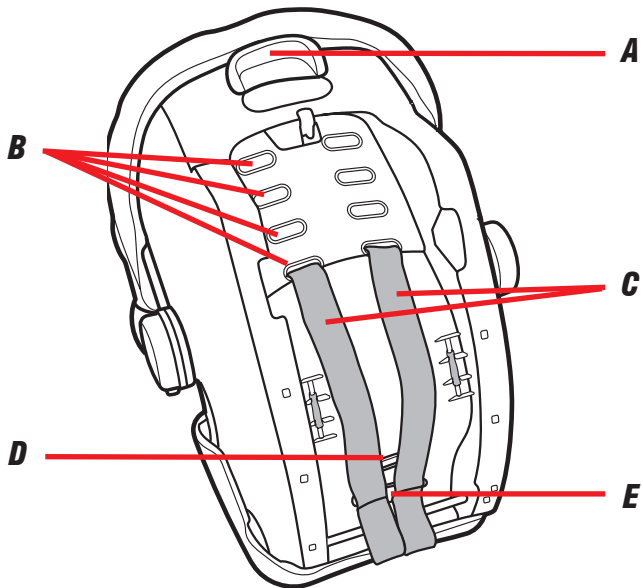

- A** *Base Release Lever*
- B** *Harness Strap Slots*
- C** *Harness Straps*
- D** *Buckle Metal Clip*
- E** *Splitter Plate*

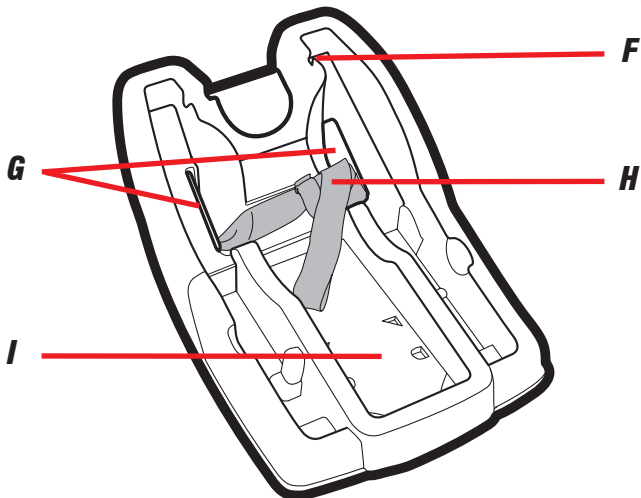

- F*** Car Seat Base Lock
- G*** Base Rear-Facing Belt Path
- H*** LATCH Strap
- I*** Instruction Manual Storage (Under Base)
- J*** LATCH Storage
- K*** Base Recline Wedge

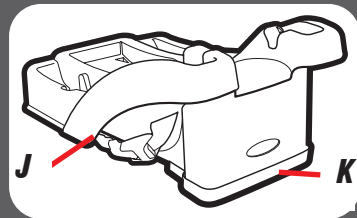

2-B Remove Car Seat from Base

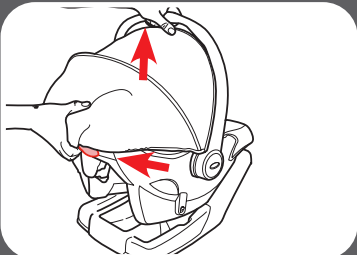

To Remove Car Seat from Base

From the back of the car seat, squeeze the base release handle and lift the car seat out of the base.

2-C Attach Car Seat to Base

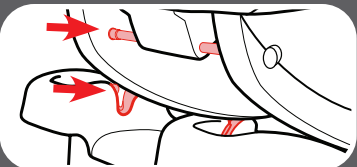

Attaching Car Seat To Base

Align the locking bar at the front of the car seat with the locks in the base. Set car seat in the base. Push down on the front of the car seat. You will hear a “click” when it is locked.

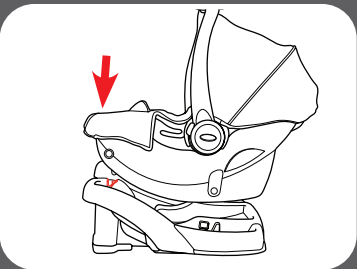

2-D Adjusting Carry Handle

1. To Rotate Handle

Press the handle adjustment buttons on both sides of handle.

MAKE SURE handle locks into position before lifting the carrier.

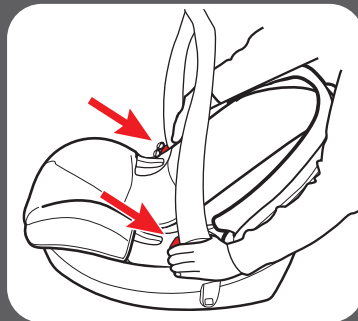

2. Handle Has 4 Positions

Rotate handle to any of the 4 locked positions. Push and pull the handle to make sure handle is in a lock position.

Carry handle MUST be upright in position A when carrying.

Handle can be in any position when used in the vehicle.

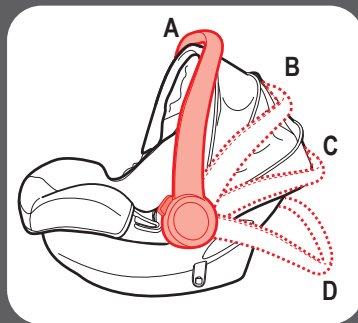

2-E Recline the Base

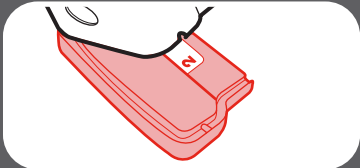
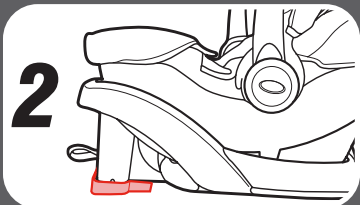
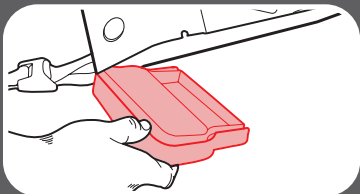
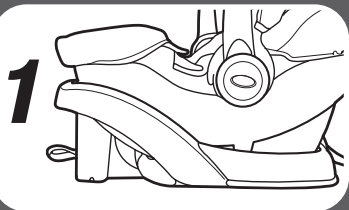

1. Base Has 3 Recline Positions

Position 1 is the least reclined position. Remove the base wedge.

For position 2, attach the base wedge with the label marked 2 facing up.

For position 3, attach the base wedge with the label marked 3 facing up.

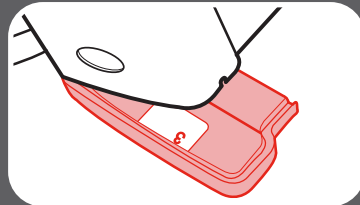
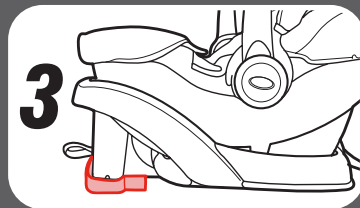

If needed, rolled towels may be placed under the base, at the vehicle seat crease, until the level line is level with the ground.

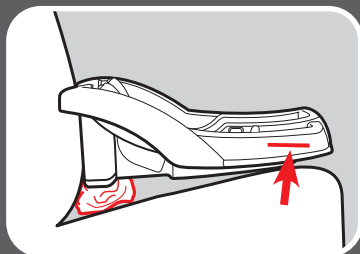

2 Features

2-F Choosing Vehicle Seat Location

Review your vehicle owner's manual for seating locations. Review section 6 for additional information.

Some vehicles have specific requirements for where the car seat can be installed. Be sure to check your vehicle owner's manual for all available seating positions.

According to accident statistics, children are safer when properly restrained in the rear seating positions than in the front seating positions. The center of the back seat can be the safest during a possible side impact.



⚠️ WARNING!



NEVER place this child restraint rear-facing in a vehicle seating location that has an active front air bag.

In the event there is no back seat, review your vehicle owner's manual to see how to use your infant child restraint.

2-G Choosing LATCH or Seat Belts

This car seat can be installed in your vehicle using either the vehicle seat belt OR the LATCH system. Both systems are equally safe to use. DO NOT USE BOTH AT THE SAME TIME. Review section 6 for additional information.

2-H What is LATCH?

LATCH consists of lower anchors, which are built-in to your vehicle, and connecting hooks that are built-in to your car seat. Lower anchors are used INSTEAD of the vehicle's seat belt to secure the child seat to the vehicle.

Review your vehicle's owner manual for exact location and use. Review section 6 for additional information.

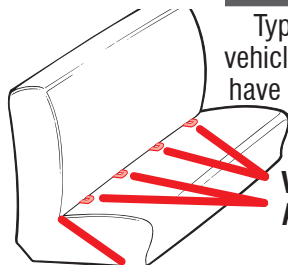

Vehicle Seat Crease

Typical seat in a passenger vehicle. Other vehicle types may have different LATCH locations.

Vehicle Lower Anchor Points

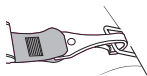

3-A Rear-Facing Safe Use Checklist

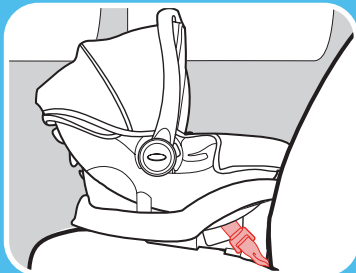

LATCH Strap

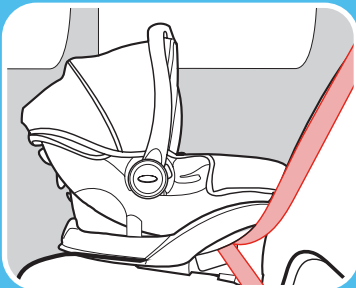

Vehicle Lap/Shoulder Seat Belt

Rear-Facing:
4-30 lb (1.8-14 kg)
30" (76 cm) or less

- Car seat **MUST** be rear-facing in the vehicle back seat.
- Make sure LATCH strap or vehicle seat belt is routed through the rear-facing belt path, marked with a blue label.
- Install this car seat tightly in your vehicle. Car seat **should not move** at the belt path more than 1" (2.5 cm) from side to side and front to back.
- Check the level line to make sure the line is level with the ground.
- Harness straps must be **at or just below** the top of child's shoulders and chest clip must be at **armpit level**.

- Make sure base is a minimum of 80% on vehicle seat.

Children are safer riding rear-facing and should ride rear-facing as long as possible, until they reach the maximum rear-facing height or weight rating for their car seat. Graco convertible and all-in-one car seats have higher rear-facing longer after outgrowing their infant car seat. Be sure to check your local and state laws, as well as AAP and NHTSA recommendations, for car seat usage.

! WARNING!

 **NEVER place this child restraint rear-facing in a vehicle seating location that has an active front air bag.**

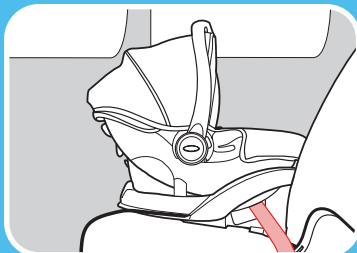

Vehicle Lap Only Seat Belt

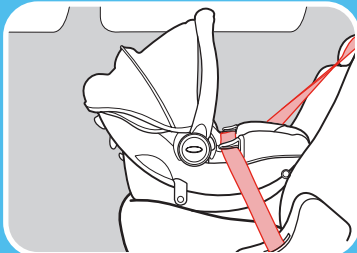

Vehicle Lap/Shoulder Seat Belt Without Base

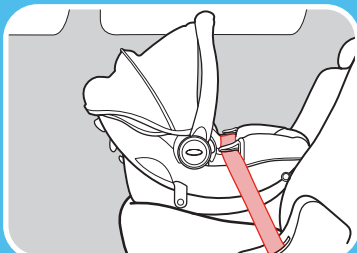

Vehicle Lap Only Seat Belt Without Base



3 Rear Facing

3-B Install With Base Rear-Facing With LATCH Strap

Review your vehicle's owner manual for LATCH location and use.

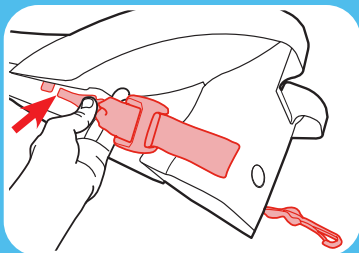

1. Remove LATCH Hooks from Storage Location

Slide each LATCH hook out of the storage location.

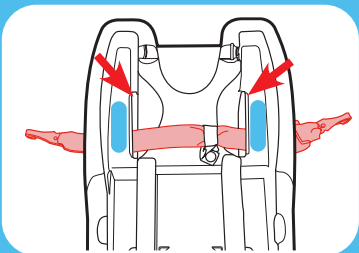

2. Make Sure LATCH Strap is in the Rear-Facing Belt Path, Marked With a Blue Label

3. Extend the LATCH Strap

Extend the LATCH strap to its maximum length by pressing the gray button and pulling on the strap.

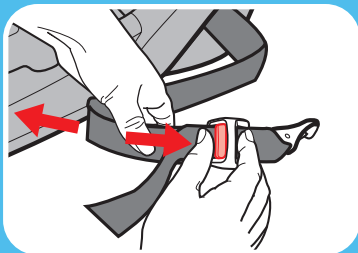

4. Place Base in Back Seat of the Vehicle

Place the base flat on the vehicle seat. Push it back until the front of the base touches the vehicle seat back. Center the base between the lower LATCH anchors.

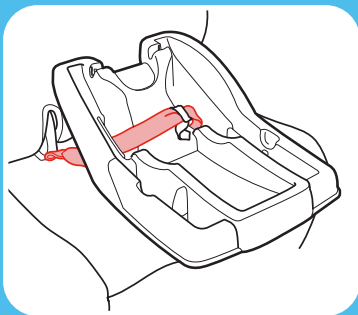

**3 Rear
Facing**

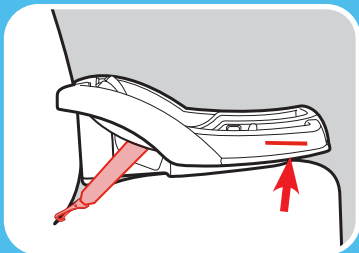

5. Check the Rear Facing Level Line

The red level line on the side of the seat **MUST BE LEVEL** with the ground.

To recline, review section 2-E.

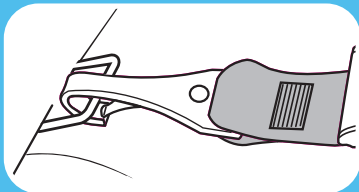

6. Connect LATCH Hooks to Vehicle's Lower LATCH Anchors

LATCH strap should lay as flat as possible and not be twisted.

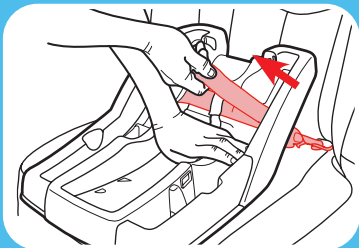

7. Tighten the LATCH Strap

Press down firmly in the center of the base while tightening the LATCH strap.

8. Test For Tightness

Grab the sides of the base where the LATCH strap is and push and pull the base from side to side and front to back.

If the base moves less than 1" (2.5 cm), it is tight enough.

9. Attach Car Seat to Base

Place car seat into the base. Push down on the front of the car seat and handle until you hear a "click".

Test to make sure the car seat is attached by pulling up on the front corners of car seat.

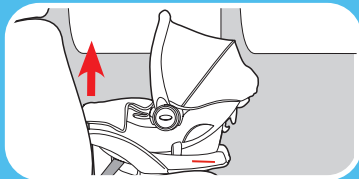
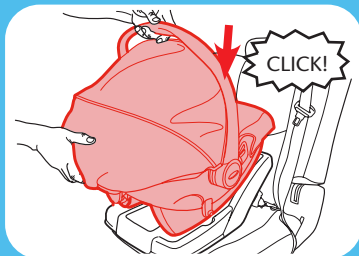

3 Rear Facing



**3 Rear
Facing**

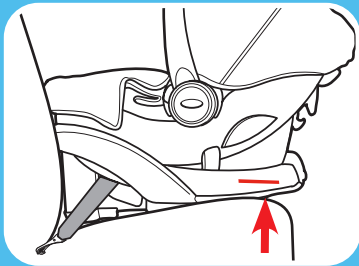

10. Check the Rear Facing Level Line

The red level line on the side of the seat **MUST BE LEVEL** with the ground.

Check the level line with child in the child restraint when making sure the line is level with the ground.

See section 4-C to secure your child.

Is Everything Correct?

Base Does Not Move
More Than 1" (2.5 cm)
At The Belt Path

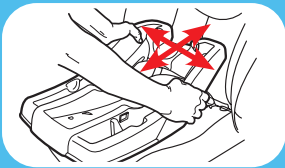

Car Seat Is Properly
Attached To Base

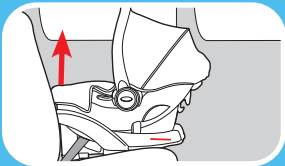

Car Seat Level to
Ground

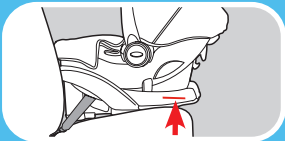

Cannot Pinch Harness



Chest Clip Even With
Armpits

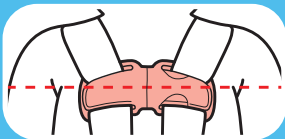

3-C Install With Base Rear-Facing With Vehicle Seat Belt

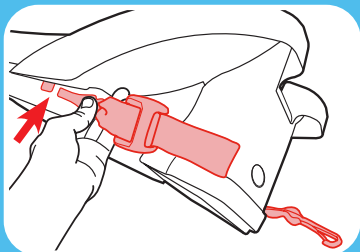

1. Store **LATCH** **Straps**

Hook the LATCH hooks into the holes on side of base as shown. Remove the slack.



2. Place Base in **Back Seat of the** **Vehicle**

Place the base flat on the vehicle seat. Push it back until the front of the base touches the vehicle seat back.



3 Rear
Facing

3. Check the Rear Facing Level Line

The red level line on the side of the seat **MUST BE LEVEL** with the ground.

To recline, review section 2-E.

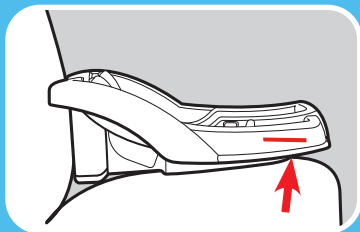

Review your vehicle's owner manual for vehicle seat belt use

4. Route the Vehicle Seat Belt

Thread vehicle seat belt through the rear-facing belt path (marked with a blue label) and buckle it. The seat belt should lay as flat as possible and not be twisted.

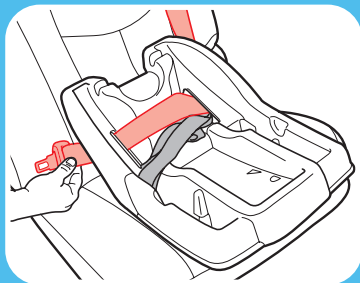



5. Lock the Vehicle Seat Belt

In most vehicles today, **slowly pull the shoulder belt all the way out** and then let it go back in. You will hear a “clicking” sound. Slowly pull out on the belt and it should be locked. If not, review your car’s owner manual and section 6-D.



6. Tighten the Vehicle Seat Belt

Press down firmly in the center of the base. Pull on the shoulder belt to tighten while feeding the slack back in the retractor.

7. Test For Tightness

Grab the sides of the base where the seat belt is and push and pull the base from side to side and front to back.

If the base moves less than 1" (2.5 cm), it is tight enough.

8. Attach Car Seat to Base

Place car seat into the base. Push down on the front of the car seat and handle until you hear a "click".

Test to make sure the car seat is attached by pulling up on the front corners of car seat.

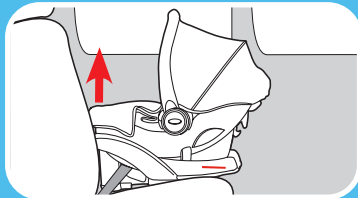
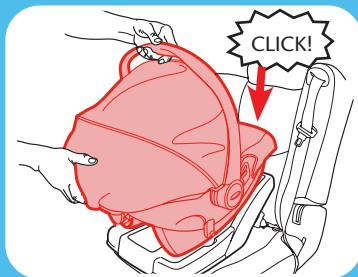

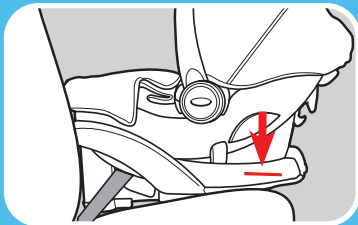

9. Check the Rear Facing Level Line

The red level line on the side of the seat **MUST BE LEVEL** with the ground.

Check the level line with child in the child restraint when making sure the line is level with the ground.

See section 4-C to secure your child.

Is Everything Correct?

Base Does Not Move
More Than 1" (2.5 cm)
At The Belt Path

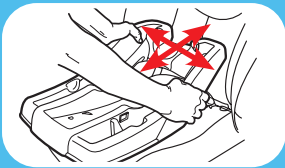

Car Seat Is Properly
Attached To Base

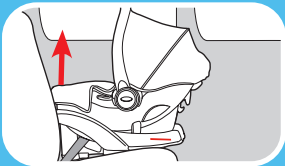

Car Seat Level to
Ground

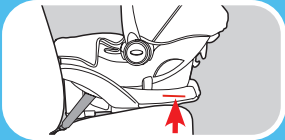

Cannot Pinch Harness



Chest Clip Even With
Armpits

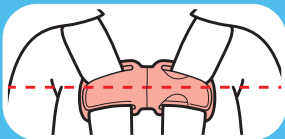

3-D Install Without Base Rear-Facing With Vehicle Seat Belt

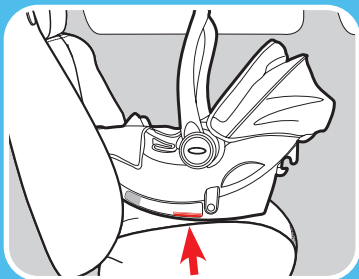

1. *Place Car Seat in Back Seat of the Vehicle*

Place the car seat on the vehicle seat. Push it back until the front of the car seat touches the vehicle seat back.

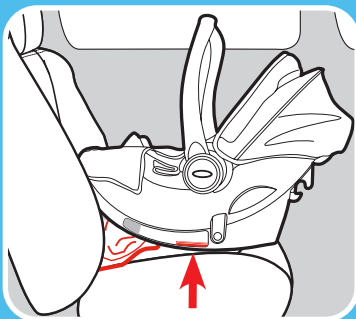

Check the rear-facing level line. The red level line on the side of the seat **MUST BE LEVEL** with the ground.

If needed, rolled towels may be placed under the base, at the vehicle seat crease, until the level line is level with the ground.



3 Rear
Facing

2. Route the Vehicle Seat Belt

Thread vehicle seat belt through the rear-facing belt path (marked with a blue label) and buckle it. The seat belt should not be twisted.

If your shoulder belt is long enough, you may route the shoulder belt behind the seat as shown.

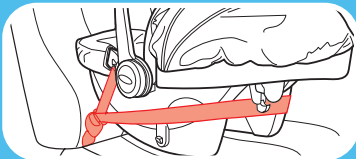
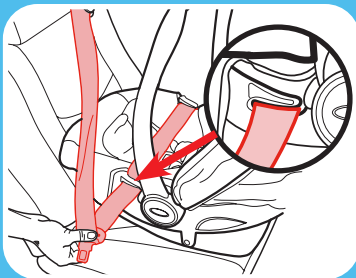

3. Lock the Vehicle Seat Belt

In most vehicles today, **slowly pull the shoulder belt all the way out** and then let it go back in. You will hear a “clicking” sound. Slowly pull out on the belt and it should be locked. If not, review your car’s owner manual and section 6-D.

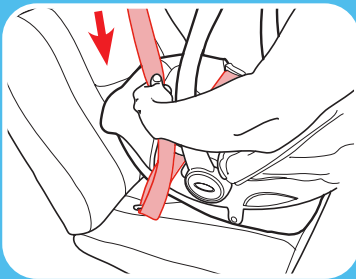

3 Rear
Facing

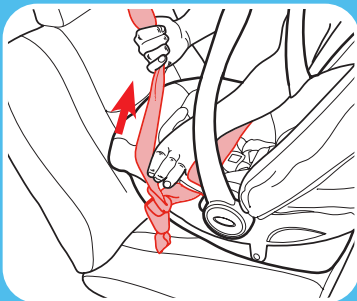

4. Tighten the Vehicle Seat Belt

Lay your forearm across the car seat **at the belt path and push down**. Pull on the shoulder belt to tighten while feeding the slack back in the retractor.

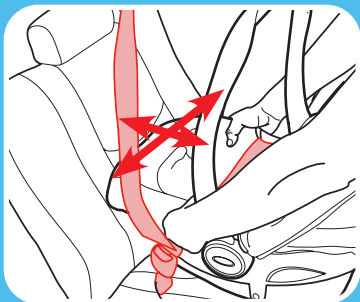

5. Test For Tightness

Grab the sides of the car seat where the seat belt is and push and pull the car seat from side to side and front to back.

If the car seat moves less than 1" (2.5 cm), it is tight enough.

6. Check the Rear Facing Level Line

The red level line on the side of the seat **MUST BE LEVEL** with the ground.

Check the level line with child in the child restraint when making sure the line is level with the ground.

If needed, rolled towels may be placed under the car seat, at the vehicle seat crease, until the level line is level with the ground.

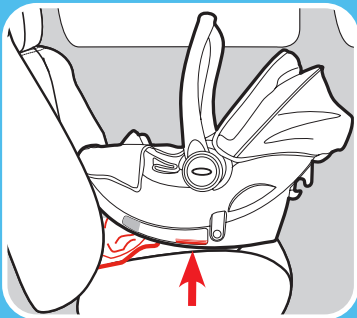
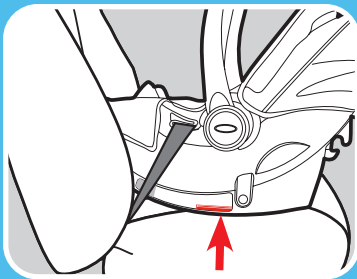

3 Rear Facing

Is Everything Correct?

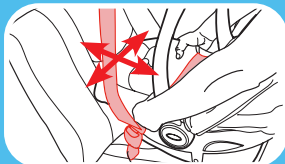

Car Seat Does Not Move More Than 1" (2.5 cm) At The Belt Path

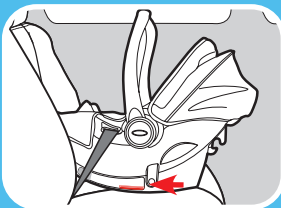

Car Seat Level to Ground



Cannot Pinch Harness

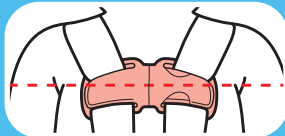

Chest Clip Even With Armpits



3 Rear Facing

4-A Adjust Harness to Fit Child



4 Securing Child

1. Loosen Harness Straps

Push down on the harness release lever while pulling out on the harness straps at the chest clip.

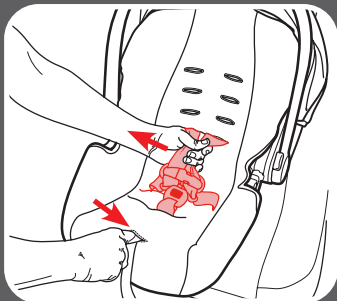

2. Release the Chest Clip

Squeeze the chest clip release buttons and pull apart.

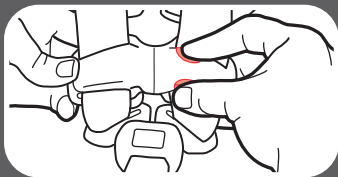



4 Securing Child

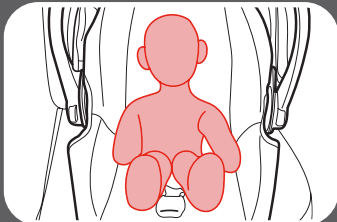

3. **Unbuckle the Buckle**

Press the red button and pull buckle tongues out. Place harness straps off to the sides.

4. **Place Your Child in the Seat**

Make sure their back is flat against the car seat back.

! WARNING!

WARNING! In cold weather, do not put snowsuits or bulky garments on your child when placing them in the car seat. Bulky clothing can prevent the harness straps from being tightened properly. To keep child warm, buckle your child in the car seat and place a blanket around the child or place the child's coat on backwards after buckling in.

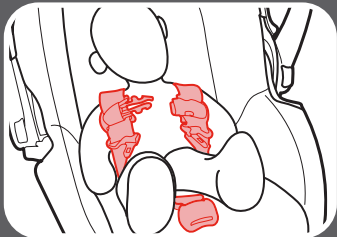

5. **Place Harness Straps Over Child's Shoulders**

6. Check Harness Height

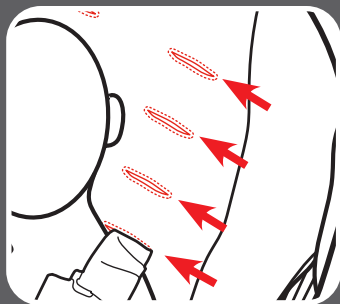

Harness Straps
**MUST BE AT OR
JUST BELOW** the
Child's Shoulders

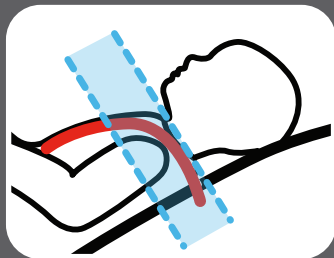

7. Top of Head **MUST
BE AT LEAST 1"**
(2.5 cm) **BELOW**
the Top of the Car
Seat

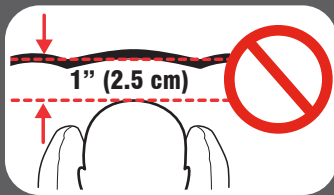

4 Securing
Child



4 Securing Child

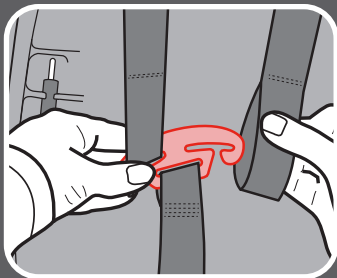

8. To Change Harness Height Positions

With harness straps loose, from the back of the car seat, remove the harness straps loops from the splitter plate.



9. Pull Harness Straps Out From the Front of Car Seat

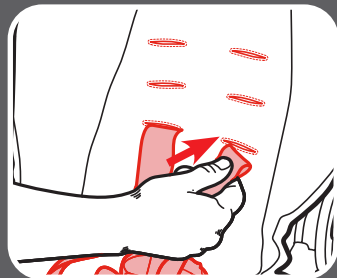

10. Insert Harness Strap Into the New Location

Make sure harness straps are not twisted and are at the same height.

11. For Smaller Baby

If the child's shoulders are even with or just above the lowest 2 slots, use the upper loops on the harness straps.

Thread the upper harness straps loops onto the splitter plate. Make sure the straps **are on top** of the splitter plate and **are completely on**.

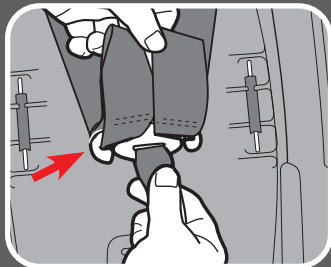
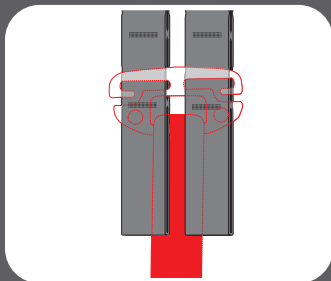
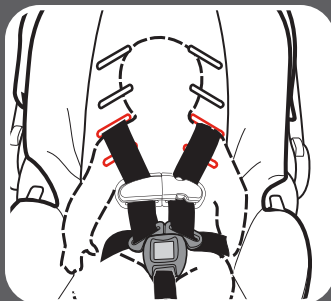
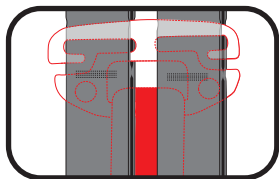

4 Securing
Child



4 Securing Child

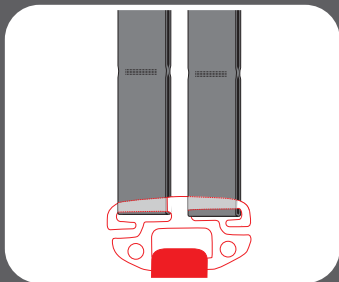
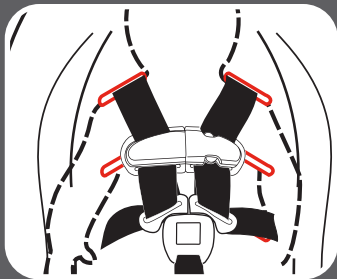

12. For Larger Baby

If the child's shoulders are even with or just above the upper 2 slots, use the lower loops on the harness straps.

Thread the lower harness straps loops onto the splitter plate. Make sure the straps **are completely on** the splitter plate.

4-B Adjust Buckle to Fit Child



4 Securing Child

1. Check the Buckle Position

The correct slot is the one that is closest to your child without being underneath them.

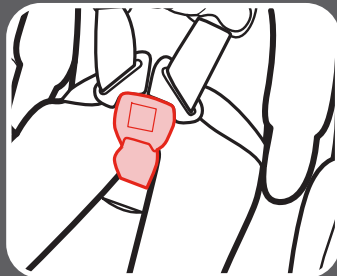

2. To Change Buckle Position

Remove child from the seat. From the bottom of car seat, insert the buckle's metal clip up through shell and pad.

From the front, pull buckle out of the pad and shell.

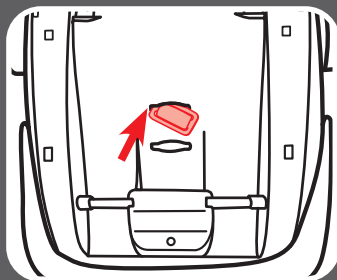



4 Securing Child

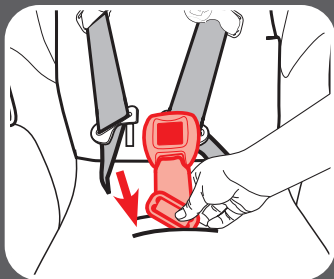

3. Insert Metal Clip Into New Location

Push metal clip down through the pad and shell. Make sure the buckle's red button is facing out.

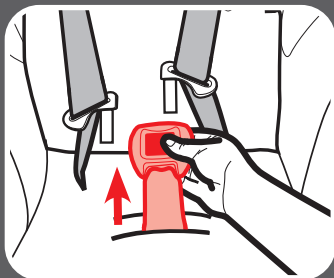

4. Pull Up On Buckle To Check It Is Secured

Make sure buckle's metal clip is completely through pad and shell.

4-C Securing Child in Car Seat



4 Securing Child

1. *Place Harness Straps Over Child's Shoulders*

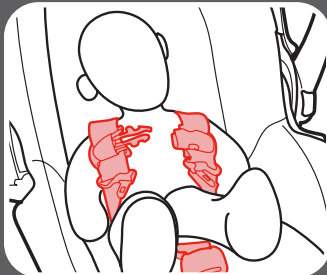

2. *Buckle*

You will hear a “click” when buckle tongues are securely attached. Pull up on each buckle tongue to make sure it is securely attached.

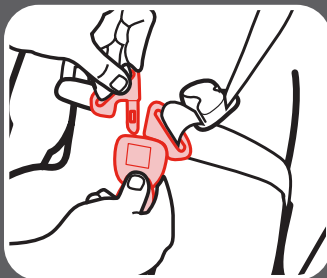

3. *Buckle the Chest Clip*

You will hear a “click” when the chest clip is securely buckled attached.

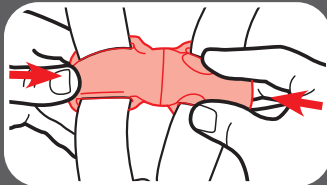



4 Securing Child

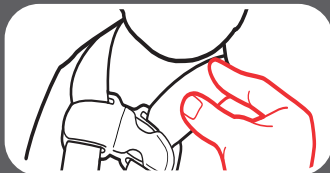
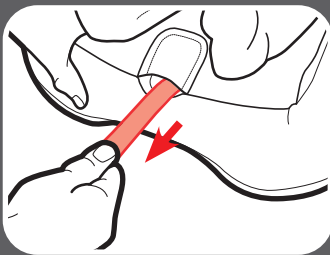
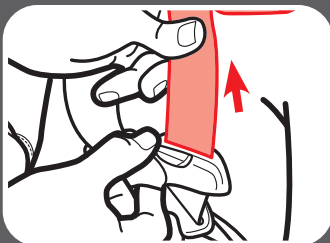

4. Pull All the Slack Out From Around the Waist

Pull up on the harness strap while pushing the chest clip down. Do this to both sides.

5. Tighten the Harness by Pulling the Harness Adjustment Strap

When you are not able to pinch any of the harness webbing at your child's shoulder, the harness is tight enough.

A snug harness should not allow any slack. It lies in a relatively straight line without sagging. It does not press on the child's flesh or push the child's body into an unnatural position.

**6. Raise the Chest
Clip to Child's
Armpit Level**

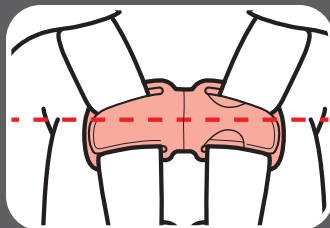

7. Check Tightness

Tighten more if
needed.

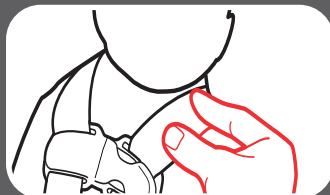

**4 Securing
Child**



4 Securing Child

4-D Removing Child

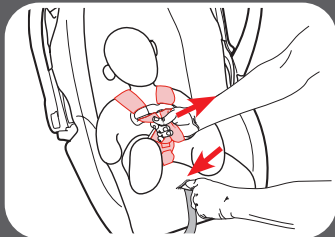

1. Loosen Harness Straps

Push down on the harness release lever while pulling out on the harness straps at the chest clip.

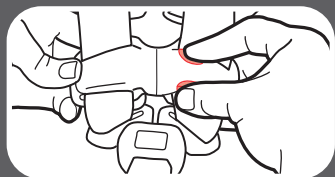

2. Release the Chest Clip

Squeeze the chest clip release buttons and pull apart.

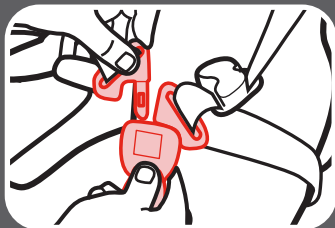

3. Unbuckle Your Child

Press in on the red button and remove the buckle tongues. Remove Child from the seat.

5-A Carrier Use

WARNING!

Read all instructions before use of the infant carrier. Keep instructions for future use. Do not use the infant carrier if it is damaged or broken.

NEVER leave child unattended. Always stay within arms reach of carrier.

SUFFOCATION HAZARD: Infant carrier can roll over on soft surfaces and suffocate child. **NEVER** place carrier on beds, sofas, or other soft surfaces.

STRANGULATION HAZARD: Children have **STRANGLING** in loose or partially buckled harness straps. Fully restrain the child even when carrier is used outside the vehicle.

FALL HAZARD: Child's movements can move carrier. **NEVER** place carrier on counter tops, tables or any other elevated surfaces.

KEEP STRINGS AND CORDS AWAY FROM CHILD. Strings and cords can cause strangulation. **DO NOT** place carrier near windows where cords from blinds or drapes can strangle a child. **DO NOT** hang strings on or over the carrier. **DO NOT** attach strings to toys.



5 Carrier
Use

! WARNING!

Fall Hazard: The carrier can fall from a shopping cart. Do not use on a shopping cart.



USE ONLY WITH STROLLERS THAT ARE PART OF THE GRACO CLICK CONNECT TRAVEL SYSTEM. Refer to the stroller owner's manual for details on how to attach the infant carrier to your stroller. If you do not have an owner's manual, please visit our website at **www.**

gracobaby.com to download the manual or call toll-free at 1-800-345-4109.



NEVER use a Graco infant carrier with any other manufacturer's strollers. This can result in serious injury or death.

6-A Additional LATCH Information

This car seat can be installed in your vehicle using either the vehicle seat belt OR the LATCH system. Both systems are equally safe to use. DO NOT USE BOTH AT THE SAME TIME.

The LATCH system allows you to securely attach your car seat in your car without using the vehicle seat belt and possibly to get a better fit. All 2003 and newer model year vehicles are required to have a LATCH system, although some manufacturers began including LATCH earlier. Some vehicle owner manuals use the term ISOFIX to identify the LATCH system.

Only use LATCH in seating positions recommended by your vehicle manufacturer. Review your vehicle owner's manual for more information.

6-B How to Remove LATCH

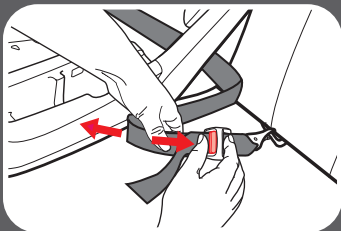

1. Push Gray Button In While Pulling on LATCH Strap to Loosen

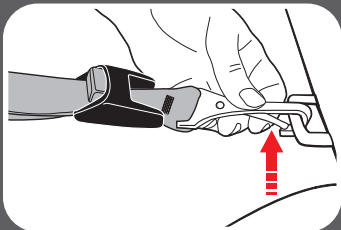

2. Press and Hold LATCH Release Hinge

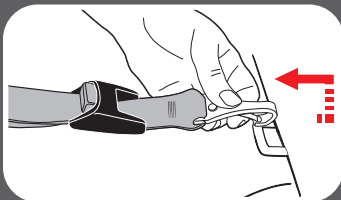

3. Push Hook In, Lift Hook Up and Pull Out Away From Anchor Point

6-C Unsafe Vehicle Seats

Never install this car seat in side-facing or rear-facing vehicle seats.



6-D Vehicle Seat Belts

Review your vehicle owner's manual for vehicle seat belt use

This car seat can be installed using a vehicle seat belt. To do this, you will need to change the seat belt to a locked mode for use with car seats. With some vehicle seat belts, this is done with the latch plate; with other vehicle seat belts, this is done with the retractor.

Vehicle Seat Belt Terms

Retractor

A device that winds up the unused vehicle seat belt. It is often hidden inside the panels on the walls of the vehicle or in the vehicle seat back.

Latch Plate

The male end of the seat belt with the silver tongue.

Seat Crease

The crease where the vehicle seat back and seat bottom meet.

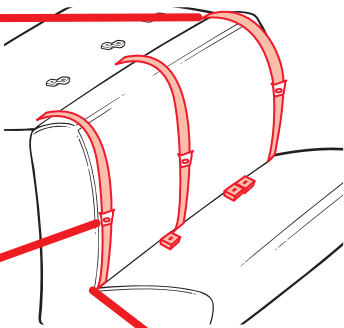

Identify Your Seat Belt Type

There are two different types of vehicle seat belts that can be used with this car seat:

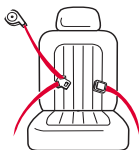

Lap/Shoulder Belt

3 connection points. Can be used in all car seats modes of use

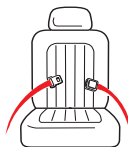

Lap Belt Only

2 connection points. **Can ONLY be used in harness mode.**

The following types of vehicle seat belts **CANNOT** be used safely with this car seat:



Lap Belt with Motorized Shoulder Belt



Lap Belt or Shoulder Belt Mounted on Door

Belts Forward of the Seat Bight



Some vehicles you may not get a secure fit. Read both your vehicle and car seat manuals.

Lap/Shoulder Seat Belt Installation

Always review your vehicle owner's manual for specific information about your vehicle seat belts.

There are three types of retractors: **ELR (Emergency Locking Retractor)**, **ALR (Automatic Locking Retractor)**, and **Switchable (ELR switch to ALR)**. To determine your type of retractor, follow these steps:

1. **Slowly** pull the belt out about halfway and stop.

2. Let the belt retract back several inches.

3. Try to **slowly** pull the belt out more.

If the belt cannot be pulled any further, it is **ALR**, ready to install your car seat. If it can be pulled further, go to the next step.

4. **Slowly** pull the belt **all the way out**, and then allow it to retract several inches. You may hear some clicking sounds.

5. Try to pull the belt all the way out again. If it cannot be pulled out, it is **Switchable**, ready to install your car seat. If it can still be pulled out freely, it is **ELR**. Review the following pages to properly install your infant car seat.

Note: Most vehicles manufactured after 1996 will have Switchable retractors in the back seat. If you have any questions about your retractor type, consult your vehicle owner's manual or call Graco for assistance.

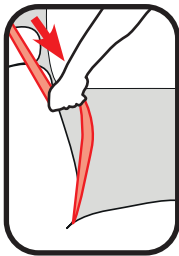

How to Lock Your Lap/Shoulder Vehicle Seat Belt

Sliding Latch Plate and Switchable Retractor

A latch plate that slides freely on the belt webbing and cannot, by itself, hold the belt snug around a car seat.

When installing the car seat, route the vehicle seat belt through the proper belt path and buckle it in.

Slowly pull the shoulder belt all the way out to switch it to locking mode. Then, as you pull the vehicle seat belt tight, feed all the slack back into the retractor.

Grab the sides of the base or seat at the belt path and slide side to side and front to back. The base or seat should not move more than 1" (2.5 cm).

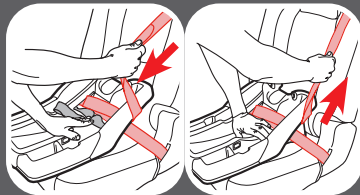
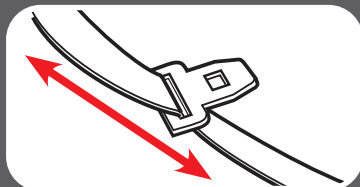

Note: With the vehicle seat belt in this locking mode, all the tension is upwards in the shoulder belt. This may start to tilt your car seat sideways. If this happens, use a locking clip instead of switching the retractor. See Sliding Latch Plate and ELR Retractor.

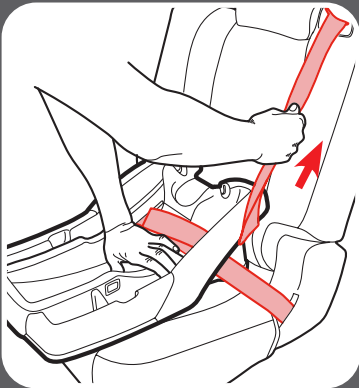
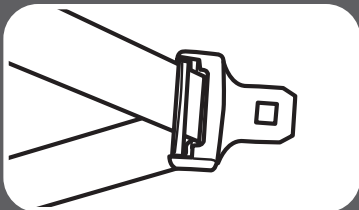

Locking Latch Plate and ELR Retractor

A latch plate that holds the lap belt snug after it has been adjusted; contains a metal bar on the underside of the hardware that “locks” the belt in position.

When installing the car seat, route the vehicle seat belt through the proper belt path and buckle it in. Then, pull upwards on the shoulder belt so that the lap belt gets tight around the base or car seat.

Grab the sides of the base or seat at the belt path and slide side to side and front to back. The base or seat should not move more than 1” (2.5 cm).

Sliding Latch Plate and ALR Retractor

A latch plate that slides freely on the belt webbing and cannot, by itself, hold the belt snug around a car seat.

Slowly pull the shoulder belt all the way out. Route the vehicle seat belt through the proper belt path and buckle it in. Then, as you pull the vehicle seat belt tight, feed all the slack back into the retractor.

Grab the sides of the base or seat at the belt path and slide side-to-side and front-to-back. The base or seat should not move more than 1" (2.5 cm).

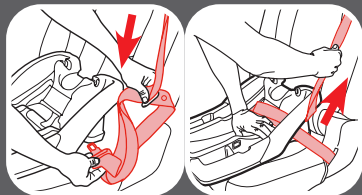
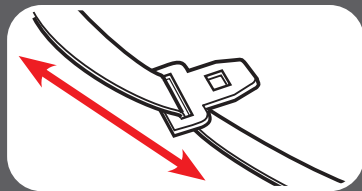

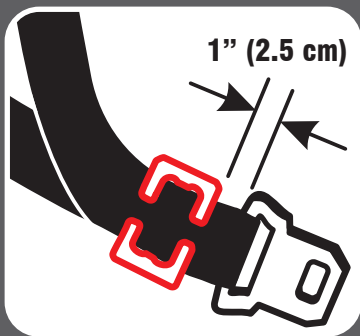
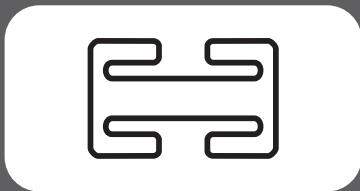
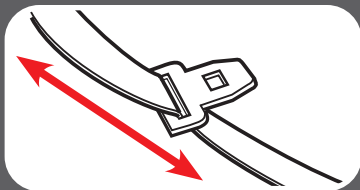

Sliding Latch Plate and ELR Retractor

A latch plate that slides freely on the belt webbing and cannot, by itself, hold the belt snug around a car seat.

With this retractor, you will need to use the locking clip to lock the vehicle seat belt.

To obtain a locking clip call 1-800-345-4109.

Route the vehicle seat belt through the proper belt path and buckle it in. Pull the vehicle seat belt tight. While pushing down on seat, pinch the two straps together behind the buckle tongue. Unbuckle the belt without allowing it to slip.

Attach locking clip to lap and shoulder belts as shown.

Buckle belt. Check that lap belt does not move by pulling hard. If belt loosens or lengthens, repeat procedure.

Lap Belt Installation

Always review your vehicle owner's manual for specific information about your vehicle seat belts.

Locking Latch Plate and No Retractor

When installing the car seat, route the lap seat belt through the proper path and buckle it in.

Then, pull upwards on the tail of the belt so that the lap belt gets tight around the car seat.

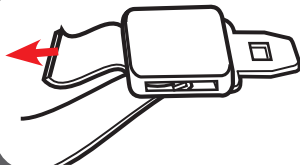

Grab the sides of the seat at the belt path and slide side to side and front to back. The base or seat should not move more than 1" (2.5 cm).

Sewn On Latch Plate and ALR Retractor

Slowly pull the lap belt all the way out. Route the vehicle seat lap belt through the proper belt path and buckle it in. Then, pull the lap belt tight while feeding all the slack back into the retractor.

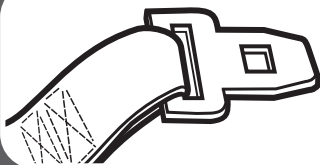

Grab the sides of the seat at the belt path and slide side to side and front to back. The base or seat should not move more than 1" (2.5 cm).

7-A Accessories *(on select models)*

!WARNING!

**To prevent ejection in sudden stop or crash:
Use body support with bottom 2 sets of harness
slots only.**

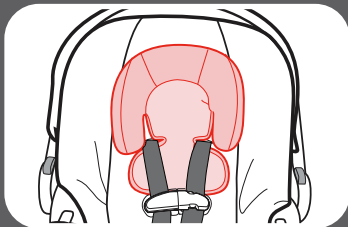

Headrest Support

To remove, pull the headrest support out from behind the harness straps.

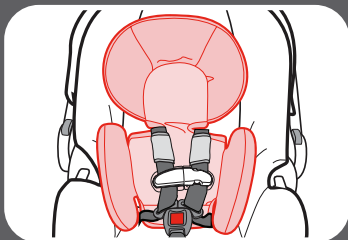

Body Support

To remove, pull the body support out from behind the harness straps.

Harness Covers

Make sure that harness covers do not interfere with the placement of the chest clip at armpit level. To remove, review section 4-A to unthread the harness system.

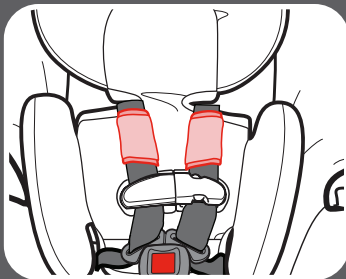

**8 Care
& Cleaning**

8-A Cleaning Seat Pad

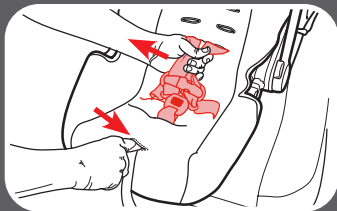

1. Loosen Harness Straps

Push down on the harness release lever while pulling out on the harness straps at the chest clip.

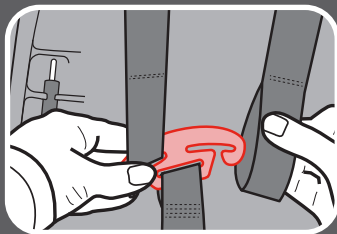

2. Remove Harness Straps from Splitter Plate



3. Pull Harness Straps Out From the Front of Car Seat

**4. Pull Out the 4
Plastic Flaps from
Sides of Seat**

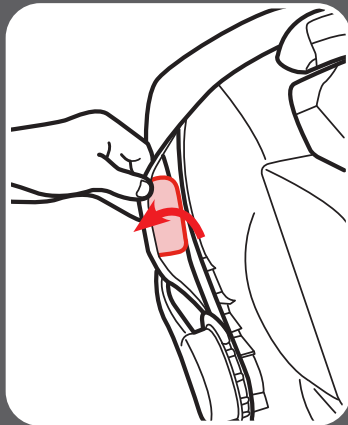
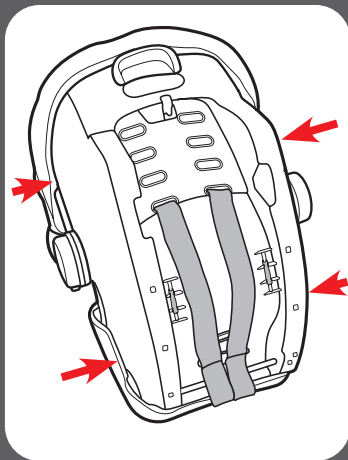
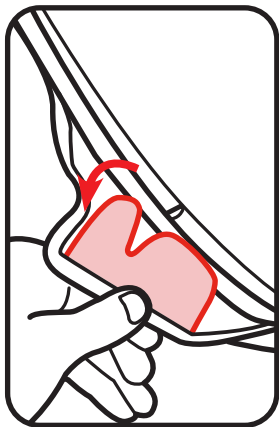

**8 Care
& Cleaning**

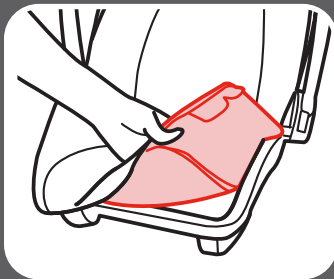

5. Pull Pad Off Shell

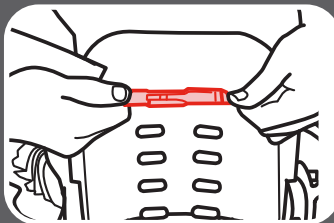

6. Remove Canopy from Canopy Hoop

(Select models)

Slide the canopy to one side of the canopy hoop. From the center, pull the canopy hoop apart and remove canopy.

Machine wash pad and canopy in cold water on delicate cycle and drip-dry. DO NOT USE BLEACH.

Reverse the steps to reattach the pad to the shell. Make sure harness straps are not twisted.

8-B Cleaning Buckle

Remove Buckle to Clean

From the bottom of car seat, insert the buckle's metal clip up through shell and pad. From the front, pull buckle out of the pad and shell.

To clean, place in a cup of warm water and gently agitate the buckle. Press the red button several times while in the water.

DO NOT SUBMERGE THE BUCKLE STRAP. DO NOT USE SOAPS, HOUSEHOLD DETERGENTS or LUBRICANTS.

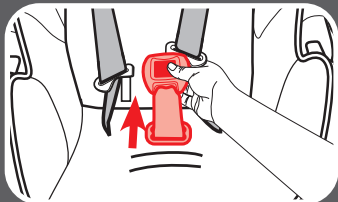
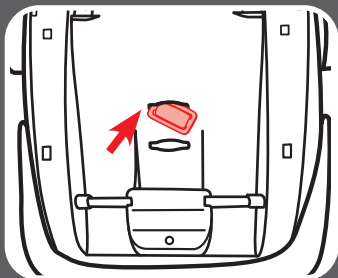

8 Care
& Cleaning

8 Care & Cleaning

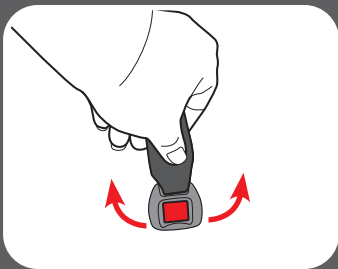

Shake out excess water and allow to air dry. Repeat steps as needed until it fastens with a click. Re-insert the buckle into the same slot it was removed. Pull up on crotch buckle to make sure it is secured.

WARNING! Inspect and clean buckle from time to time to remove any objects or debris that could prevent latching.

8-C Cleaning Harness and LATCH

Surface wash only with mild soap and damp cloth. **DO NOT IMMERSE THE HARNESS STRAPS or LATCH STRAP IN WATER.** Doing so may weaken the straps.

If harness straps or LATCH belt are frayed or heavily soiled, contact Customer Service at www.gracobaby.com or 1-800-345-4109.



8 Care
& Cleaning

NOTES

Replacement Parts

To purchase parts or accessories in the United States,
please contact us at the following:

www.gracobaby.com

or

1-800-345-4109

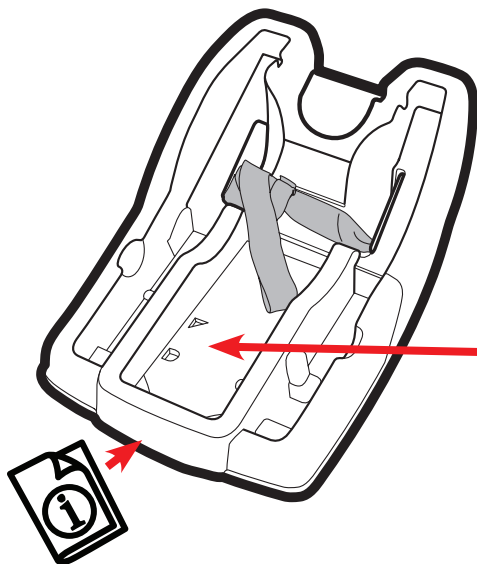

Store instruction
manual in the slots
on the bottom of
the base where the
instruction book icon
is shown.