

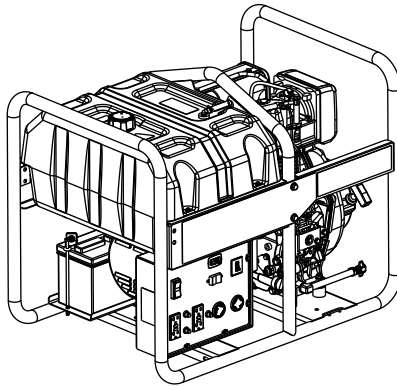

XD5000E Diesel Portable Generator
Owner's Manual



000703

MODEL: _____
SERIAL: _____
DATE PURCHASED: _____

Register your Generac product at:
WWW.GENERAC.COM
1-888-GENERAC

SAVE THIS MANUAL FOR FUTURE REFERENCE

Table of Contents

Section 1 Introduction and Safety 1

Introduction	1
Safety Rules	1
Safety Symbols and Meanings	1
Exhaust and Location Hazards	2
Electrical Hazards	2
Fire Hazards	3
Standards Index	3

Section 2 General Information and Setup 4

Know Your Generator	5
Emissions Information	5
Hour Meter	6
Connection Plugs	6
Remove Contents from Carton	7
Assembly	7
Battery Installation (if equipped)	8
Add Engine Oil	8
Fuel	9

Section 3 Operation 10

Operation and Use Questions	10
Before Starting Engine	10
Prepare Generator for Use	10
Grounding the Generator When Used as a Portable	10
Know Generator Limits	10
Transporting/Tipping of the Unit	11
Starting Pull Start Engines	12
Starting Electric Start Engines	12
Low Oil Pressure Switch	13

Section 4 Maintenance and

Troubleshooting	14
Maintenance Recommendations ...	14
Maintenance Schedule	14
Preventive Maintenance	14
Engine Maintenance	14
Battery Replacement (if applicable)	15
Valve Clearance	16
Storage	16
Troubleshooting	17
Notes	19

WARNING

California Proposition 65. Engine exhaust and some of its constituents are known to the state of California to cause cancer, birth defects, and other reproductive harm. (000004)

WARNING

California Proposition 65. This product contains or emits chemicals known to the state of California to cause cancer, birth defects, and other reproductive harm. (000005)

Section 1 Introduction and Safety

Introduction

Thank you for purchasing a Generac Power Systems Inc. product. This unit has been designed to provide high-performance, efficient operation, and years of use when maintained properly.



WARNING

Consult Manual. Read and understand manual completely before using product. Failure to completely understand manual and product could result in death or serious injury. (000100a)

If any section of the manual is not understood, contact your nearest authorized dealer, or contact Generac Customer Service at 1-888-GENERAC, or www.generac.com with any questions or concerns.

The owner is responsible for proper maintenance and safe use of the equipment. Before operating, servicing or storing this generator:

- Study all warnings in this manual and on the product carefully.
- Become familiar with this manual and the unit before use.
- Refer to the Assembly section of the manual for instructions on final assembly procedures. Follow the instructions completely.

Save these instructions for future reference. ALWAYS supply this manual to any individual that will use this machine.

THE INFORMATION CONTAINED HEREIN WAS BASED ON MACHINES IN PRODUCTION AT THE TIME OF PUBLICATION. GENERAC RESERVES THE RIGHT TO MODIFY THIS MANUAL AT ANY TIME.

Safety Rules

The manufacturer cannot anticipate every possible circumstance that might involve a hazard. The warnings in this manual, and on tags and decals affixed to the unit are, therefore, not all inclusive. If using a procedure, work method or operating technique that the manufacturer does not specifically recommend, verify that it is safe for others. Also make sure the procedure, work method or operating technique utilized does not render the equipment unsafe.

Throughout this publication, and on tags and decals affixed to the generator, DANGER, WARNING, CAUTION and NOTE blocks are used to alert personnel to special instructions about a particular operation that may be hazardous if performed incorrectly or carelessly. Observe them carefully. Their definitions are as follows:

DANGER

Indicates a hazardous situation which, if not avoided, will result in death or serious injury.

(000001)

WARNING

Indicates a hazardous situation which, if not avoided, could result in death or serious injury.

(000002)

CAUTION

Indicates a hazardous situation which, if not avoided, could result in minor or moderate injury.

(000003)

NOTE: Notes contain additional information important to a procedure and will be found within the regular text of this manual.

These safety warnings cannot eliminate the hazards that they indicate. Common sense and strict compliance with the special instructions while performing the action or service are essential to preventing accidents.

Safety Symbols and Meanings

DANGER

Using a generator indoors CAN KILL YOU IN MINUTES.

Generator exhaust contains carbon monoxide. This is a poison you cannot see or smell.



NEVER use inside a home or garage, EVEN IF doors and windows are open.



Only use OUTSIDE and far away from windows, doors, and vents.

000657

DANGER



Asphyxiation. Running engines produce carbon monoxide, a colorless, odorless, poisonous gas. Carbon monoxide, if not avoided, will result in death or serious injury. (000103)

DANGER



Electrocution. Water contact with a power source, if not avoided, will result in death or serious injury.

(000104)

**⚠ DANGER**

Electrocution. Turn utility and emergency power supplies to OFF before connecting power source and load lines. Failure to do so will result in death or serious injury. (000116)

- For safety reasons, it is recommended that the maintenance of this equipment be performed by an Authorized Service Facility. Inspect the generator regularly, and contact the nearest Authorized Dealer for parts needing repair or replacement.
- Operate generator only on level surfaces and where it will not be exposed to excessive moisture, dirt, dust or corrosive vapors.

**⚠ WARNING**

Moving Parts. Keep clothing, hair, and appendages away from moving parts. Failure to do so could result in death or serious injury. (000111)

**⚠ WARNING**

Hot Surfaces. When operating machine, do not touch hot surfaces. Keep machine away from combustibles during use. Hot surfaces could result in severe burns or fire. (000108)

⚠ WARNING

Equipment and property damage. Do not alter construction of, installation, or block ventilation for generator. Failure to do so could result in unsafe operation or damage to the generator. (000146)

⚠ WARNING

Do not insert any object through the air cooling slots. Generator can start at any time and could result in death, serious injury and unit damage. (000142)

- When working on this equipment, remain alert at all times.
- Never work on the equipment when physically or mentally fatigued.
- Never use the generator or any of its parts as a step. Stepping on the unit can stress and break parts, and may result in dangerous operating conditions from leaking exhaust gases, fuel leakage, oil leakage, etc.

**⚠ WARNING**

Hearing Loss. Hearing protection is recommended when using this machine. Failure to wear hearing protection could result in permanent hearing loss. (000107)

Exhaust and Location Hazards

**⚠ DANGER**

Asphyxiation. Running engines produce carbon monoxide, a colorless, odorless, poisonous gas. Carbon monoxide, if not avoided, will result in death or serious injury. (000103)

⚠ WARNING

Equipment and property damage. Do not alter construction of, installation, or block ventilation for generator. Failure to do so could result in unsafe operation or damage to the generator. (000146)

- This exhaust system must be properly maintained. Do nothing that might render the exhaust system unsafe or in noncompliance with any local codes and/or standards.

**⚠ WARNING**

Asphyxiation. Always use a battery operated carbon monoxide alarm indoors and installed according to the manufacturer's instructions. Failure to do so could result in death or serious injury. (000178a)

- If you start to feel sick, dizzy, or weak after the generator has been running, move to fresh air IMMEDIATELY. See a doctor, as you could have carbon monoxide poisoning.

Electrical Hazards

**⚠ DANGER**

Electrocution. Contact with bare wires, terminals, and connections while generator is running will result in death or serious injury. (000144)

**⚠ DANGER**

Electrocution. Water contact with a power source, if not avoided, will result in death or serious injury. (000104)

- The National Electric Code (NEC) requires the frame and external electrically conductive parts of the generator be properly connected to an approved earth ground. Local electrical codes may also require proper grounding of the generator. Consult with a local electrician for grounding requirements in the area.
- Use a ground fault circuit interrupter in any damp or highly conductive area (such as metal decking or steel work).

**⚠ DANGER**

Electrocution. In the event of electrical accident, immediately shut power OFF. Use non-conductive implements to free victim from live conductor. Apply first aid and get medical help. Failure to do so will result in death or serious injury. (000145)

⚠WARNING

Accidental Start-up. Disconnect the negative battery cable, then the positive battery cable when working on unit. Failure to do so could result in death or serious injury. (000130)

Fire Hazards**⚠DANGER**

Explosion and Fire. Fuel and vapors are extremely flammable and explosive. Add fuel in a well ventilated area. Keep fire and spark away. Failure to do so will result in death or serious injury. (000105)

**⚠DANGER**

Do not overfill fuel tank. Fill to 1/2 in. of top of tank to allow for fuel expansion. Overfilling may cause fuel to spill onto engine causing fire or explosion, which will result in death or serious injury. (000166)

- Wipe up any fuel or oil spills immediately. Verify that no combustible materials are left on or near the generator. Keep the area surrounding the generator clean and free from debris and keep a clearance of five (5) feet on all sides to allow for proper ventilation of the generator.

⚠WARNING

Do not insert any object through the air cooling slots. Generator can start at any time and could result in death, serious injury and unit damage.

(000142)

- Do not operate the generator if connected electrical devices overheat, if electrical output is lost, if engine or generator sparks or if flames or smoke are observed while unit is running.
- Keep a fire extinguisher near the generator at all times.

Standards Index

1. National Fire Protection Association (NFPA) 70: The NATIONAL ELECTRIC CODE (NEC) available from www.nfpa.org
2. National Fire Protection Association (NFPA) 5000: BUILDING CONSTRUCTION AND SAFETY CODE available from www.nfpa.org
3. International Building Code available from www.iccsafe.org
4. Agricultural Wiring Handbook available from www.rerc.org, Rural Electricity Resource Council P.O. Box 309 Wilmington, OH 45177-0309
5. ASAE EP-364.2 Installation and Maintenance of Farm Standby Electric Power available from www.asabe.org, American Society of Agricultural & Biological Engineers 2950 Niles Road, St. Joseph, MI 49085

This list is not all inclusive. Check with the Authority Having Jurisdiction (AHJ) for any local codes or standards which may be applicable to your jurisdiction.

Section 2 General Information and Setup

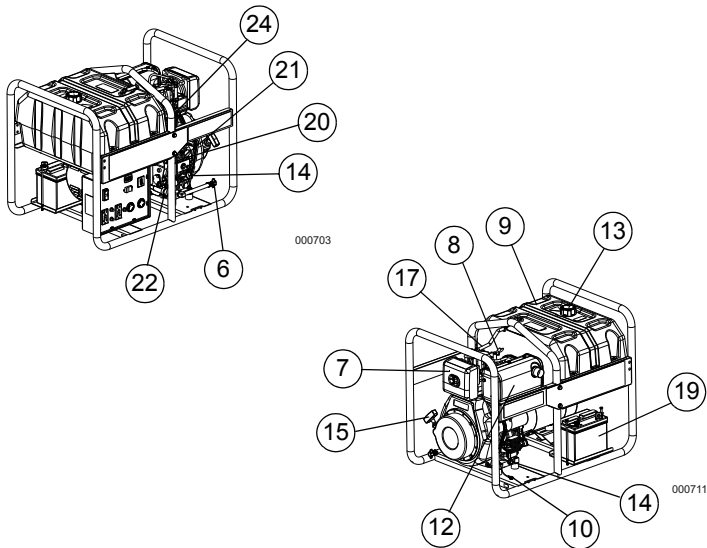

Figure 2-1. Features and Controls

TABLE 1. Generator Components

1	120 Volt AC, 20 Amp, GFCI Duplex Receptacle
2	120/240 Volt AC, 30 Amp Locking Receptacle
3	120 Volt AC, 30 Amp Locking Receptacle
4	20 Amp Circuit Breakers
5	30 Amp Circuit Breaker
6	Oil Drain
7	Air Filter
8	Decompression Lever
9	Fuel Tank
10	Grounding Lug
11	Start/Run Switch
12	Muffler
13	Fuel Cap/Fuel Gauge
14	Oil Fill (2 locations)
15	Recoil Starter
16	Main 23 Amp Breaker Switch
17	Fuel Return Hose
18	Hour Meter
19	Battery (if equipped)

20	Fuel Filter
21	Engine On/Off Lever
22	Fuel On/Off
23	Voltage Selector Switch
24	Fuel Primer Bulb

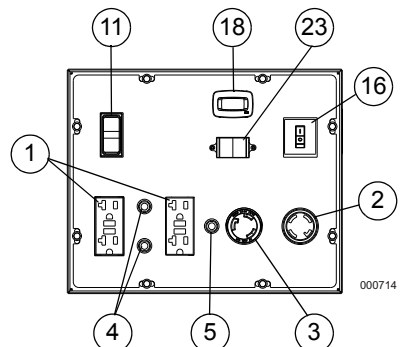
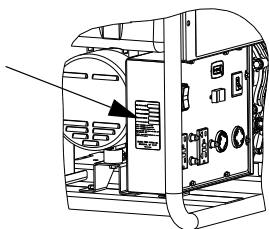

Figure 2-2. Control Panel



000705

Figure 2-3. Identification Label

Emissions Information

The U.S. Environmental Protection Agency, EPA, (and California Air Resource Board, CARB, for equipment certified to CA standards) require the generator comply with exhaust emission standards. The generator is certified to meet applicable EPA and CARB emission levels using Ultra Low Sulfur fuel, Diesel No. 2. Any other use may be a violation of federal and/or local laws. To ensure the engine complies with applicable emission standards for the duration of the engine's life, it is important to follow the maintenance specifications in Maintenance Section. **Tampering with or altering the emission control system may increase emissions and may be a violation of Federal or California Law.**

Know Your Generator



WARNING

Consult Manual. Read and understand manual completely before using product. Failure to completely understand manual and product could result in death or serious injury. (000100a)

Replacement owner's manuals are available at www.generac.com.

TABLE 2. Product Specifications

Generator Specifications	
Rated Power	Rated 5000 Watts**
Surge Power	Surge Rating 5500 Watts
Rated AC Voltage	120/240
Rated AC Load Current @ 240V Current @ 120V	20.8 Amps** 41.7 Amps**
Rated Frequency	60 Hz @3600 RPM
Phase	Single Phase
** Operating Temperature Range : -18 deg. C (0 deg. F) to 40 Deg. C (104 Deg. F). When operated above 25 deg. C (77 deg. F) there may be a decrease in power.	
** Maximum wattage and current are subject to, and limited by, such factors as fuel Btu content, ambient temperature, altitude, engine condition, etc.. Maximum power decreases about 3.5% for each 1,000 feet above sea level; and will also decrease about 1% for each 6° C (10° F) above 16° C (60° F) ambient temperature.	
5.5 / 6.5 Engine Specifications	
Displacement	435 cc (26.5 in ³)
Fuel Capacity	45.4 L (12 U.S. gallons)
Oil Type	See chart in the "Add Engine Oil." section.
Oil Capacity	1.6L (1.7 qt)
Run Time at 50% Load	32 Hours

Hour Meter

The Hour Meter tracks hours of operation for scheduled maintenance. See [Figure 2-4](#).

- The CHG OIL display will illuminate every 100 hours. The message will flash one hour before and one hour after each 100 hour interval, providing a two hour window to perform service.
- The SVC display will illuminate every 100 hours. The message will flash one hour before and one hour after each 200 hour interval providing a two hour window to perform service.

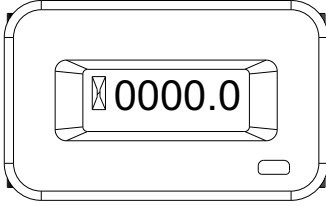

000205

Figure 2-4. Hour Meter

When the hour meter is in flash alert mode, the maintenance message will alternate with elapsed time in hours and tenths. The hours will flash four times, then alternate with the maintenance message four times until the meter automatically resets.

- 100 hours - CHG OIL — Oil Change Interval (Every 100 hrs)
- 200 hours - SVC — Service Air Filter (Every 200 hrs)

NOTE: The hour glass icon will flash when the engine is running. This signifies the meter is recording hours of operation.

Connection Plugs

120 VAC, 20 Amp, GFCI Duplex Receptacle

The 120 Volt outlet is overload protected by a 20 Amp push-to-reset circuit breaker. See [Figure 2-5](#). Each receptacle will power 120 Volt AC, single phase, 60 Hz electrical loads requiring up to 2400 watts (2.4 kW) or 20 Amps of current. Use only high quality, well-insulated, 3-wire grounded cord sets rated for 125 Volts at 20 Amps (or greater).

NOTE: Limit length of extension cords to fifteen feet, or less, to prevent voltage drop and overheating of wires.

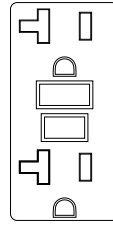

000203

Figure 2-5. 120 VAC, 20 Amp, Duplex Receptacle

120/240 VAC, 30 Amp Receptacle

Use a NEMA L14-30 plug with this receptacle (rotate to lock/unlock). Connect a suitable 4-wire grounded cord set to plug and desired load. The cord set should be rated 250 Volts AC at 30 Amps (or greater). See [Figure 2-6](#).

Use this receptacle to operate 240 Volt AC, 60 Hz, single phase loads requiring up to 5000 watts (5.0 kW) of power at 20.8 Amps.

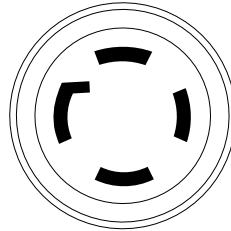

000204

Figure 2-6. 120/240 VAC, 30 Amp Receptacle

120 VAC, 30 Amp Receptacle

Use a NEMA L5-30 plug with this receptacle (rotate to lock/unlock). Connect a suitable 3-wire cord set to the plug and to desired load. The cord set should be rated for 125 Volts AC at 30 Amps (or greater). See [Figure 2-7](#).

Use this receptacle to operate 120 Volt AC, 60Hz, single phase loads requiring up to 3600 watts (3.6kW) of power at 30 Amps. The outlet is protected by a 30 Amp push-to-reset circuit breaker.

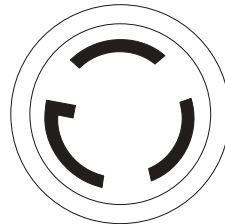

000844

Figure 2-7. 120 VAC, 30 Amp Receptacle

Remove Contents from Carton

1. Open carton completely by cutting each corner from top to bottom.
2. Remove and verify carton contents prior to assembly. Carton contents should contain the following:

TABLE 3. Contents

Item	Qty.
Main Unit	1
Owner's Manual	1
Liter Oil SAE 30	2
Product Registration Card	3
Service Warranty	1
Emissions Warranty	1
Muffler Extension	1
Battery Bracket Assembly	1

TABLE 4. Portability Kit (optional)

Portability Kit (optional)	Qty.
10" Wheel (A)	2
Axle (B)	1
Axle Mount (C)	2
5/8" Flat Washer (D)	4
Cotter Pin (E)	2
Handle (F)	1
Handle Mount (G)	2
Handle Grip (H)	2
Frame Foot (J)	2
Rubber Feet (K)	2
M6-1x50mm Screw (L)	4
.344"x1.0" Flat Washer (M)	2
M8 Flat Washer (N)	10
M8-1.25 Locknut (P)	6
M8-1.25x30 Screw (Q)	2
M8-1.25x45 Screw (R)	2
M8-1.25x50 Screw (S)	2
M8-1.25x110 Screw (T)	2
5/16x1.25 Pin Release (U)	1
Lanyard	1

3. Call Generac Customer Service 1-888-GENERAC with the unit model and serial number for any missing carton contents.

4. Record model, serial number, and date of purchase on front cover of this manual.

Assembly



WARNING

Consult Manual. Read and understand manual completely before using product. Failure to completely understand manual and product could result in death or serious injury. (000100a)

Call Generac Customer Service at 1-888-GENERAC for any assembly issues or concerns. Please have model and serial number available.

The following tools are required to install the accessory kit.

- Ratchet with 10mm and 13mm sockets
- 13mm box wrenches

NOTE: The wheels are not intended for over-the-road use.

Install wheels as follows. See [Figure 2-8](#).

1. Insert cotter pin (E) to one end of axle (B).
2. In this order; slide washer (D), wheel (A), washer, (D), axle mount (2-C), washer (D), wheel (A), washer (D), and cotter pin (E) onto axle.
3. Place wheel assembly under frame so axle mounts align with holes in cradle frame.
4. Secure with M6 screws (L).

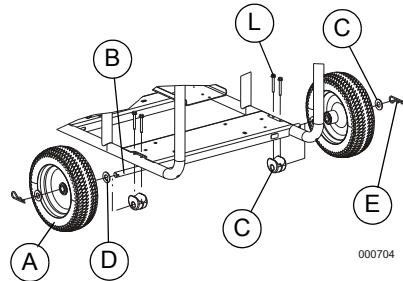

Figure 2-8. Wheel Assembly

Install frame foot and rubber bumpers as shown in [Figure 2-9](#).

1. Slide onto M8 screw (Q), flat washer (M), rubber foot (K).
2. Slide assembly through frame foot (J). Add M8 flat washer (N), and secure with M8-1.25 Locknut (P).
3. Place foot bracket assembly under cradle.
4. Slide M8 flat washers (N) onto M8-1.25x110 screws (T) and insert through foot bracket assembly and cradle.
5. Secure with M8 flat washer (N) and M8 locknut (P).

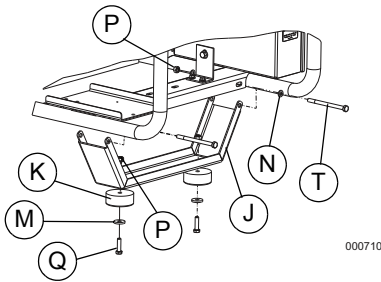

Figure 2-9. Frame Foot Assembly

Install handle as shown in [Figure 2-10](#).

1. Place a M8 flat washer (N) onto M8-1.25x45 screw (R) and through handle bracket and handle (A).
2. Secure with M8 flat washer (N) and M8 locknut (P).
3. Install handle grips (H).

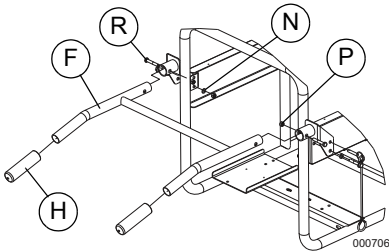

Figure 2-10. Handle Assembly

Battery Installation (if equipped)

The following tools are required to install the battery.

- 7/16" (11mm) ratchet, socket and wrench
1. Place battery onto battery tray with the positive terminal on the right.
 2. Connect red battery wire to positive (+) terminal with a bolt, washer and nut.
 3. Slide red battery terminal post cover over terminal and hardware.
 4. Connect black battery wire to negative (-) terminal with a bolt, washer and nut.
 5. Slide black battery terminal post cover over terminal and hardware.
 6. Slide one spacer onto each screw.
 7. Slide these assemblies through holes in top of bracket.
 8. Place bracket assembly over top of battery. Do not touch battery terminal hardware. The screws will pass through holes on battery tray.
 9. Place washer, lock washer and wing nut onto screw.

10. Tighten wing nuts until the lock washers are compressed to being flat.

NOTE: If the battery is unable to start the engine, charge it with the 12V charger included in the accessory box (see the "Charging a Battery" section for details).

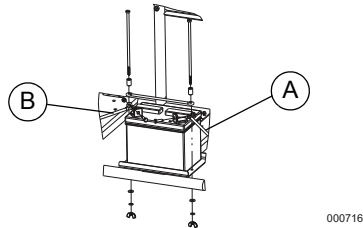

Figure 2-11. Battery Installation

Add Engine Oil



Engine damage. Verify proper type and quantity of engine oil prior to starting engine. Failure to do so could result in engine damage.

(000135)

Use high detergent, premium quality motor oil certified for service class CI-4 or CJ-4. SAE 20W-40 is recommended for general, all temperature use. See [Figure 2-12](#).

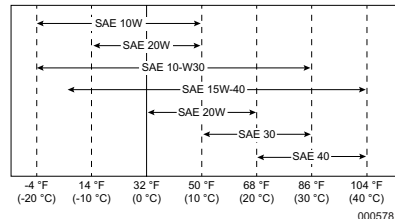

Figure 2-12. Oil Recommendations

1. Place generator on a level surface.
2. Verify oil fill area is clean.
3. Remove oil fill cap and wipe dipstick clean. See [Figure 2-13](#).

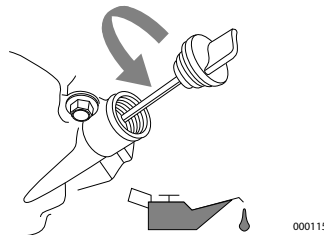
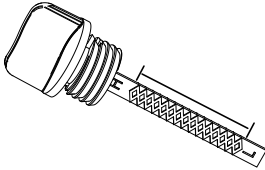

Figure 2-13. Remove Dipstick

-
4. Add recommended engine oil.

NOTE: Some units have more than one oil fill location. It is only necessary to use one oil fill point.

5. Thread dipstick into oil filler neck. Oil level is checked with dipstick fully installed.
6. See [Figure 2-14](#). Remove dipstick and verify oil level is within safe operating range.
7. Install oil fill cap/dipstick and hand-tighten.



000116

Figure 2-14. Safe Operating Range

Fuel



▲ DANGER

Explosion and Fire. Fuel and vapors are extremely flammable and explosive. Add fuel in a well ventilated area. Keep fire and spark away. Failure to do so will result in death or serious injury. (000105)



▲ DANGER

Do not overfill fuel tank. Fill to 1/2 in. of top of tank to allow for fuel expansion. Overfilling may cause fuel to spill onto engine causing fire or explosion, which will result in death or serious injury. (000166)

IMPORTANT! DO NOT use Home Heating Oil or Bio-Diesel Fuel.

Use No. 2D diesel fuel when temperatures are above freezing. When temperatures are below freezing, blend No. 1D diesel fuel and No. 2D diesel fuel together for a climate adjusted fuel ratio.

Diesel fuel must meet the following requirements:

- Sulfur content of 15 parts per million (ppm) maximum.
- Minimum Cetane index of 40.

NOTE: Low ambient temperatures as well as engine operation at high altitudes may require the use of fuels with higher Cetane ratings.

Fuel Maintenance

- Always treat diesel fuel for long term storage. Use the approved fuel additive and water abatement material. Test stored fuel every 90 days and provide additional treatment if required. Periodically check and dry abatement material as necessary.

Section 3 Operation

Operation and Use Questions

Call Generac customer service at 1-888-GENERAC with questions or concerns about equipment operation and maintenance.

Before Starting Engine

1. Verify engine oil level is correct.
2. Verify fuel level is correct.
3. Verify unit is secure on level ground, with proper clearance and is in a well ventilated area.

Prepare Generator for Use



▲ DANGER

Asphyxiation. Running engines produce carbon monoxide, a colorless, odorless, poisonous gas. Carbon monoxide, if not avoided, will result in death or serious injury. (000103)



▲ DANGER

Asphyxiation. Always use a battery operated carbon monoxide alarm indoors and installed according to the manufacturer's instructions. Failure to do so will result in death or serious injury. (000178)

▲ DANGER

The exhaust system must be properly maintained. Do not alter or modify the exhaust system as to render it unsafe or make it noncompliant with local codes and/or standards. Failure to do so will result in death or serious injury. (000179)



▲ DANGER

Risk of fire. Do not use generator without spark arrestor installed. Failure to do so could result in death or serious injury. (000118)



▲ WARNING

Risk of Fire. Hot surfaces could ignite combustibles, resulting in fire. Fire could result in death or serious injury. (000110)



▲ WARNING

Hot Surfaces. When operating machine, do not touch hot surfaces. Keep machine away from combustibles during use. Hot surfaces could result in severe burns or fire. (000108)

▲ CAUTION

Equipment and property damage. Disconnect electrical loads prior to starting or stopping unit. Failure to do so could result in equipment and property damage. (000136)

Grounding the Generator When Used as a Portable

The generator is equipped with an equipment ground connecting the generator frame and the ground terminals on the AC output receptacles (see NEC 250.34 (A)). This allows the generator to be used as a portable without grounding the frame of the generator as specified in NEC 250.34. See [Figure 3-1](#).

- Neutrals bonded to frame.

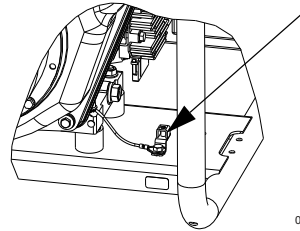

000707

Figure 3-1. Grounding the Generator

Special Requirements

Review all Federal or State Occupational Safety and Health Administration (OSHA) regulations, local codes, or ordinances that apply to the intended use of the generator.

Consult a qualified electrician, electrical inspector, or the local agency having jurisdiction:

- In some areas, generators are required to be registered with local utility companies.
- If the generator is used at a construction site, there may be additional regulations which must be observed.

Connecting the Generator to a Building Electrical System

When connecting directly to a building electrical system, it is recommended that a manual transfer switch be used. Connections for a portable generator to a building electrical system must be made by a qualified electrician and in strict compliance with all national and local electrical codes and laws.

Know Generator Limits

Overloading a generator can result in damage to the generator and connected electrical devices. Observe the following to prevent overload:

- Add up the total wattage of all electrical devices to be connected at one time. This total should NOT be greater than the generator's wattage capacity.

- The rated wattage of lights can be taken from light bulbs. The rated wattage of tools, appliances, and motors can be found on a data label or decal affixed to the device.
- If the appliance, tool, or motor doesn't give wattage, multiply volts times ampere rating to determine watts (volts x amps = watts).
- Some electric motors, such as induction types, require about three times more watts of power for starting than for running. This surge of power lasts only a few seconds when starting such motors. Make sure to allow for high starting wattage when selecting electrical devices to connect to the generator:

1. Figure the watts needed to start the largest motor.
2. Add to that figure the running watts of all other connected loads.

The Wattage Reference Guide is provided to assist in determining how many items the generator can operate at one time.

NOTE: All figures are approximate. See data label on appliance for wattage requirements.

Table 3. Wattage Reference Guide

Device	Running Watts
*Air Conditioner (12,000 Btu)	1700
*Air Conditioner (24,000 Btu)	3800
*Air Conditioner (40,000 Btu)	6000
Battery Charger (20 Amp)	500
Belt Sander (3")	1000
Chain Saw	1200
Circular Saw (6-1/2")	800 to 1000
*Clothes Dryer (Electric)	5750
*Clothes Dryer (Gas)	700
*Clothes Washer	1150
Coffee Maker	1750
*Compressor (1 HP)	2000
*Compressor (3/4 HP)	1800
*Compressor (1/2 HP)	1400
Curling Iron	700
*Dehumidifier	650
Disc Sander (9")	1200
Edge Trimmer	500
Electric Blanket	400
Electric Nail Gun	1200
Electric Range (per element)	1500
Electric Skillet	1250
*Freezer	700
*Furnace Fan (3/5 HP)	875

*Garage Door Opener	500 to 750
Hair Dryer	1200
Hand Drill	250 to 1100
Hedge Trimmer	450
Impact Wrench	500
Iron	1200
*Jet Pump	800
Lawn Mower	1200
Light Bulb	100
Microwave Oven	700 to 1000
*Milk Cooler	1100
Oil Burner on Furnace	300
Oil Fired Space Heater (140,000 Btu)	400
Oil Fired Space Heater (85,000 Btu)	225
Oil Fired Space Heater (30,000 Btu)	150
*Paint Sprayer, Airless (1/3 HP)	600
Paint Sprayer, Airless (hand-held)	150
Radio	50 to 200
*Refrigerator	700
Slow Cooker	200
*Submersible Pump (1-1/2 HP)	2800
*Submersible Pump (1 HP)	2000
*Submersible Pump (1/2 HP)	1500
*Sump Pump	800 to 1050
*Table Saw (10")	1750 to 2000
Television	200 to 500
Toaster	1000 to 1650
Weed Trimmer	500
* Allow 3 times the listed watts for starting these devices.	

Transporting/Tipping of the Unit

Do not operate, store or transport the unit at an angle greater than 15 degrees.

Starting Pull Start Engines



⚠️WARNING

Recoil Hazard. Recoil could retract unexpectedly. Kickback could result in death or serious injury.

(000183)

⚠️CAUTION

Equipment and property damage. Disconnect electrical loads prior to starting or stopping unit. Failure to do so could result in equipment and property damage.

(000136)

1. Unplug all electrical loads from the unit's receptacles before starting engine.
2. Place generator on a level surface.
3. Turn main breaker switch Off (A). See [Figure 3-2](#).
4. Turn fuel valve On (B). See [Figure 3-2](#).

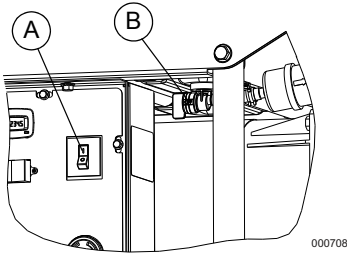

000708

Figure 3-2. Main Breaker Switch and Fuel On/Off Valve

5. See [Figure 3-3](#). Switch engine control lever to Run (B).

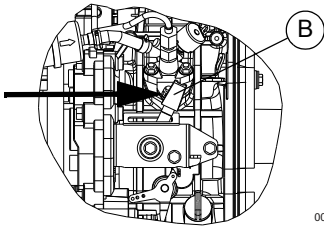

000712

Figure 3-3. Engine Control Lever

6. See [Figure 3-4](#). Press control panel engine Run/Stop switch to Run (C).
7. Squeeze primer bulb 5-10 times until firm. The fuel filter should show fuel level at least half full.
8. Firmly grasp recoil handle and pull slowly until increased resistance is felt. Flip red decompression lever on top of engine. Pull rapidly up and away.
 - Repeat this procedure until the engine starts. If the engine does not start within 5 pulls, confirm steps 1-6 and perform step 7 again.

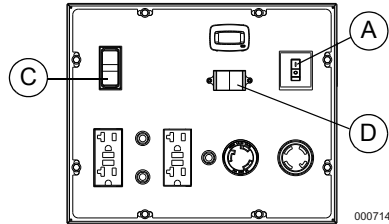

000714

Figure 3-4. Engine Run/Stop Switch

1. Allow engine to run for at least 10 seconds, then turn main breaker On (A). See [Figure 3-2](#) or [Figure 3-4](#).
2. Select voltage rating with voltage selector (D). See [Figure 3-4](#).

IMPORTANT: Do not overload the generator. Also, do not overload individual panel receptacles. These outlets are protected against overload with push-to-reset type circuit breakers. If amperage rating of any circuit breaker is exceeded, that breaker opens and electrical output to that receptacle is lost. Read **"Know Generator Limits."** carefully.

Starting Electric Start Engines

⚠️CAUTION

Equipment and property damage. Disconnect electrical loads prior to starting or stopping unit. Failure to do so could result in equipment and property damage.

(000136)

1. Turn main breaker switch to Off (A). See [Figure 3-2](#) or [Figure 3-4](#).
2. Unplug all electrical loads from the unit's receptacles before starting engine.
3. Place generator on a level surface.
4. Turn fuel valve On (A). See [Figure 3-2](#).
5. See [Figure 3-3](#). Switch engine control lever to Run (B).
6. Squeeze primer bulb 5-10 times until firm. The fuel filter should show fuel level at least half full.
7. Press and hold the Engine Start switch (C) until engine starts. See [Figure 3-4](#). Release Engine Start switch if engine does not start within 5 seconds. If engine does not start within 5 seconds, review start-up procedure again before attempting start. If problems persist, refer to **"Troubleshooting."**
8. Turn Main Breaker to On.
9. Select voltage rating with Voltage Selector (D).

Generator Shut Down



Equipment and property damage. Disconnect electrical loads prior to starting or stopping unit. Failure to do so could result in equipment and property damage.

(000136)

1. Turn main breaker switch Off.
2. Switch engine start switch to Off.
3. Turn fuel valve Off.

Emergency Shutdown Procedure

1. Press down on small red lever on lower engine controls (near recoil handle and dipstick) to the Stop position.
2. Turn main breaker switch Off.
3. Switch engine start switch to Off.
4. Turn fuel valve Off.

To re-start engine, the engine control lever must be moved to Run (B). See [Figure 3-3](#).

Low Oil Pressure Switch

The engine is equipped with a low oil pressure switch that shuts down the engine automatically when the oil level drops below a specified level. The engine will not run until the oil has been filled to the proper level.

If the engine shuts down and there is sufficient fuel, check engine oil level.

Section 4 Maintenance and Troubleshooting

Maintenance Recommendations

Regular maintenance will improve performance and extend generator life. See a qualified dealer for service.

Generator warranty does not cover items subjected to operator abuse or negligence. To receive full warranty value, operator must maintain generator as instructed in this manual, including proper storage as detailed in the "Storage." section.

NOTE: Call 1-888-GENERAC with questions about component replacement.

Maintenance Schedule

Follow maintenance schedule intervals, whichever occurs first according to use.

NOTE: Adverse conditions will require more frequent service.

NOTE: All required service and adjustments should be each season as detailed in the following chart.

At Each Use
Check engine oil level
Every Season
Check valve clearance***
Every 200 Hours or Every Season
Inspect/clean air cleaner filter**
Change oil and oil filter †*
Check engine speed control
Drain fuel tank & replace outlet fuel filter
Every 1000 Hours
Check compression
Every 1500 Hours
Inspect, clean & test fuel injection nozzle
Every 2000 Hours
Check & replace fuel hoses
† Change oil after first 50 hours of operation, then every season. * Change oil and oil filter every month when operating under heavy load or in high temperatures. ** Clean more often under dirty or dusty operating conditions. Replace air filter parts if they cannot be adequately cleaned. *** Check valve clearance and adjust if necessary after first 50 hours of operation and every 400 hours thereafter.

Preventive Maintenance

Dirt or debris can cause improper operation and equipment damage. Clean generator daily or before each use. Keep area around and behind muffler free from combustible debris. Inspect all cooling air openings on generator.

WARNING

Do not insert any object through the air cooling slots. Generator can start at any time and could result in death, serious injury and unit damage.

(000142)

- Use a damp cloth to wipe exterior surfaces clean.
- Use a soft bristle brush to loosen caked on dirt, oil, etc.
- Use a vacuum to pick up loose dirt and debris.
- Low pressure air (not to exceed 25 psi [172 kPa]) may be used to blow away dirt. Inspect cooling air slots and openings on generator. These openings must be kept clean and unobstructed.

NOTE: DO NOT use a garden hose to clean generator. Water can enter engine fuel system and cause problems. If water enters generator through cooling air slots, some water will be retained in voids and crevices of rotor and stator winding insulation. Water and dirt buildup on generator internal windings will decrease insulation resistance of windings.

Engine Maintenance

Engine Oil Recommendations

Use high detergent, premium quality motor oil certified for service class CI-4 or CJ-4. SAE 20W-40 is recommended for general, all temperature use. See [Figure 4-1](#).

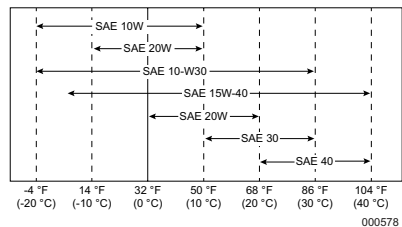

Figure 4-1. Oil Recommendations

Inspect Engine Oil Level

⚠WARNING

Risk of burns. Allow engine to cool before draining oil or coolant. Failure to do so could result in death or serious injury.

(000139)

Inspect engine oil level prior to each use, or every 8 hours of operation.

1. Place generator on a level surface.
2. Clean area around oil fill.
3. See **Figure 4-2**. Remove oil fill cap and wipe dipstick clean.

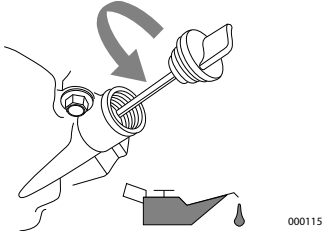

Figure 4-2. Engine Oil Fill

4. Screw dipstick into filler neck. Verify oil level is within safe operating range. See **Figure 4-3**.

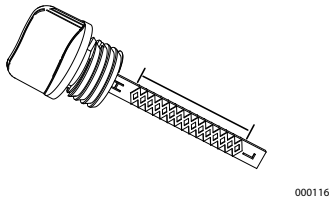

Figure 4-3. Safe Operating Range

5. Add recommended engine oil as necessary.
6. Replace oil fill cap and hand-tighten.

NOTE: Some units have more than one oil fill location. It is only necessary to use one oil fill point.

Change Engine Oil

⚠WARNING

Accidental start-up. Disconnect spark plug wires when working on unit. Failure to do so could result in death or serious injury.

(000141)

When using generator under extreme, dirty, dusty conditions, or in extremely hot weather, change oil more frequently.

NOTE: Don't pollute. Conserve resources. Return used oil to collection centers.

Change oil while engine is still warm from running, as follows:

1. Place generator on a level surface.
2. Clean area around oil fill, and oil drain plug.
3. Remove oil fill cap.
4. Remove oil drain plug and drain oil completely into a suitable container.
5. Install oil drain plug and tighten securely.
6. Slowly pour oil into oil fill opening until oil level is between the crosshatch marks on dipstick. **DO NOT** overfill.
7. Install oil fill cap, and finger tighten.
8. Wipe up any spilled oil.
9. Properly dispose of oil in accordance with all applicable regulations.

Air Filter

Engine will not run properly and may be damaged if run with a dirty air filter. Service air filter more frequently in dirty or dusty conditions. To service air filter:

1. See **Figure 4-4**. Turn knob (A) and remove air filter cover.
2. Wash in soapy water. Squeeze filter dry in clean cloth (**DO NOT TWIST**).
3. Clean air filter cover before re-installing it.

NOTE: To order a new air filter, contact the nearest Authorized Service Facility at 1-888-GENERAC.

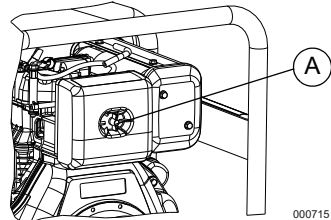

Figure 4-4. Air Filter Assembly

Battery Replacement (if applicable)

NOTE: A battery may lose some charge when not in use for prolonged periods of time.

⚠WARNING

Accidental Start-up. Disconnect the negative battery cable, then the positive battery cable when working on unit. Failure to do so could result in death or serious injury.

(000130)

The following tools are required to replace the battery.

- 7/16" (11mm) ratchet, socket and wrench

See **Figure 4-5**.

1. Disconnect negative (-) battery terminal **FIRST** (A).

2. Disconnect positive (+) battery terminal SECOND (B).
3. Loosen wing nuts and remove battery bracket and hardware.
4. Replace battery by following instructions in the **"Battery Installation (if equipped)."** section.

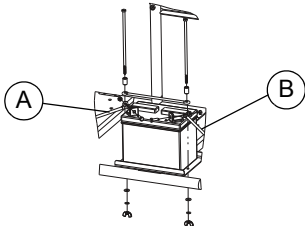

000716

Figure 4-5. Battery Connection

Inspect Muffler and Spark Arrestor (if equipped)

NOTE: It is a violation of California Public Resource Code, Section 4442, to use or operate the engine on any forest-covered, brush-covered, or grass-covered land unless the exhaust system is equipped with a spark arrestor, as defined in Section 4442, maintained in effective working order. Other states or federal jurisdictions may have similar laws.

Contact original equipment manufacturer, retailer, or dealer to obtain a spark arrestor designed for exhaust system installed on this engine.

NOTE: Use **ONLY** original equipment replacement parts.

Inspect muffler for cracks, corrosion, or other damage. Remove spark arrestor, if equipped, inspect for damage or carbon blockage. Replace parts as required.

Valve Clearance

IMPORTANT: If uncomfortable about doing this procedure, or the proper tools are not available, take generator to the nearest service center to have valve clearance adjusted.

Check valve clearance after the first fifty-hours of operation. Contact Authorized Service Facility.

Storage

General



⚠ DANGER

Explosion and Fire. Fuel and vapors are extremely flammable and explosive. Store fuel in a well ventilated area. Keep fire and spark away. Failure to do so will result in death or serious injury. (000143)



⚠ WARNING

Risk of Fire. Verify machine has properly cooled before installing cover and storing machine. Hot surfaces could result in fire.

(000109)

It is recommended to start and run the generator for 30 minutes, every 30 days. If this is not possible, refer to the following list to prepare unit for storage.

- DO NOT place a storage cover on a hot generator. Allow unit to cool to room temperature before storage.
- DO NOT store fuel from one season to another unless properly treated.
- Replace fuel container if rust is present. Rust in fuel will cause fuel system problems.
- Cover unit with a suitable protective, moisture resistant cover.
- Store unit in a clean and dry area.
- Always store generator and fuel away from heat and ignition sources.

Prepare Fuel System for Storage



⚠ WARNING

Vision Loss. Eye protection is required to avoid spray from spark plug hole when cranking engine. Failure to do so could result in vision loss.

(000181)

Recoil Start

1. Push and hold decompression down and slowly pull recoil starter 2 to 3 times. Do not start engine.
2. Pull decompression lever up. Pull recoil slowly until resistance is felt. This will close valves so moisture cannot enter engine cylinder. Gently release recoil.

Electric Start

1. Push and hold decompression lever down.
2. Push Start/Run/Stop switch to turn the engine for 2 to 3 seconds. Do not start engine.
3. Pull decompression lever up. Pull recoil slowly until resistance is felt. This will close valves so moisture cannot enter engine cylinder. Gently release recoil.
4. Completely drain fuel tank or completely fill fuel tank to proper level.

NOTE: Always treat diesel fuel for long term storage. Use the approved fuel additive and water abatement material. Test stored fuel every 90 days and provide additional treatment if required. Periodically check and dry abatement material as necessary.

Change Oil

Change engine oil before storage. See *"Change Engine Oil."*

Return Engine to Service

1. Refer to the *"Before Starting Engine."* section.
2. Start engine and run at no load for 5 to 10 minutes while checking:
 - oil pressure
 - fuel, engine oil or coolant leaks
 - proper operation of indicators/gauges

NOTE: Avoid prolonged operation at minimum or maximum engine speeds and loads for the first hour of operation.

Troubleshooting

PROBLEM	CAUSE	CORRECTION
Engine is running, but AC output is not available.	<ol style="list-style-type: none"> 1. Circuit breaker OPEN. 2. Poor connection or defective cord set. 3. Connected device is bad. 4. Fault in generator. 5. Main breaker switch is OFF. 6. Voltage selector switch is OFF. 7. Generator is overloaded. 8. GFCI outlet has tripped. 	<ol style="list-style-type: none"> 1. Reset circuit breaker. 2. Check and repair. 3. Connect another device that is in good condition. 4. Contact Authorized Service Facility. 5. Switch main breaker ON. 6. Switch voltage selector switch to desired voltage output. 7. See <i>"Know Generator Limits."</i> 8. Correct ground fault in circuit and reset GFCI.
Engine runs well at no-load, but bogs when load is applied.	<ol style="list-style-type: none"> 1. Short circuit in a connected load. 2. Generator is overloaded. 3. Engine speed is too slow. 4. Shorted generator circuit. 	<ol style="list-style-type: none"> 1. Disconnect shorted electrical load. 2. See <i>"Know Generator Limits."</i> 3. Contact Authorized Service Facility. 4. Contact Authorized Service Facility.
Engine will not start; or starts and runs rough.	<ol style="list-style-type: none"> 1. Incorrect start sequence. 2. Fuel valve is OFF. 3. Dirty air filter. 4. Out of fuel. 5. Stale or contaminated fuel. 6. Low oil level. 7. Excessive rich fuel mixture. 8. Dirty fuel filter. 9. Air in fuel system. 10. Engine is under electrical load. 	<ol style="list-style-type: none"> 1. Review & follow starting procedure. 2. Turn fuel valve ON. 3. Clean or replace air filter. 4. Fill fuel tank. 5. Drain fuel tank and fill with fresh fuel. 6. Fill crankcase to correct level. 7. Contact Authorized Service Facility. 8. Replace fuel filter. 9. Contact Authorized Service Facility. 10. Remove all equipment from receptacles. Make sure the main breaker switch is OFF.

PROBLEM	CAUSE	CORRECTION
Engine shuts down during operation.	<ol style="list-style-type: none"> 1. Out of fuel. 2. Low oil level. 3. Fault in engine. 4. Ambient temp too high. 	<ol style="list-style-type: none"> 1. Fill fuel tank. Prime fuel system. See "Starting Pull Start Engines." or "Starting Electric Start Engines." 2. Fill crankcase to correct level. 3. Contact Authorized Service Facility. 4. Move unit to cooler location and allow engine to cool before running again.
Engine lacks power.	<ol style="list-style-type: none"> 1. Load is too high. 2. Dirty air filter. 3. Engine needs to be serviced. 4. Excessive valve lash. 5. Dirty fuel filter. 6. Fuel injector clogged. 	<ol style="list-style-type: none"> 1. Reduce load. See "Know Generator Limits." 2. Clean or replace air filter. 3. Contact Authorized Service Facility. 4. Contact Authorized Service Facility. 5. Replace fuel filter. 6. Contact Authorized Service Facility.
Engine surges or stumbles.	<ol style="list-style-type: none"> 1. Governor/throttle assembly is not adjusted properly. 2. Air in fuel system. 	<ol style="list-style-type: none"> 1. Contact Authorized Service Facility. 2. Contact Authorized Service Facility.

Notes





Part No. 0L3191 Rev. A 06/18/15
Printed in USA
©2015 Generac Power Systems, Inc. All rights reserved
Specifications are subject to change without notice.
No reproduction allowed in any form without prior written consent from Generac Power Systems, Inc.

Generac Power Systems, Inc.
S45 W29290 Hwy. 59
Waukesha, WI 53189
1-888-GENERAC
generac.com